

POWRMATIC®

AIRCO290

Installation & Servicing Manual

Issue 1.0 July 2022



AIRCO290

Certificate Of Guarantee

POWRMATIC[®] Certificate of Guarantee

This is to certify that this Air Conditioner is guaranteed for a period of 12 months, parts only from the date of original installation.

To make a claim

In the first instance you must contact your appliance supplier, or installer and provide:-

1. The appliance type and serial number.
2. The original Warranty Registration form. As much detail as possible on the fault.
3. Your supplier, or installer, will then contact Powrmatic to make a guarantee claim on your behalf.

Conditions of Guarantee

1. The Air Conditioner must have been installed by a competent installer, and in accordance with the manufacturer's instructions and any building regulations and local regulations.
2. A copy of the Warranty Registration form, must be returned to Powrmatic.
3. The Air Conditioner has been maintained on a yearly basis by a competent and qualified servicing company.
4. The Air Conditioner has been used in accordance with the manufacturer's instructions.
5. The correct specification voltage has been used.
6. No unauthorised repairs or modifications have been made. Powrmatic 'General Conditions of Sales' have been observed.
7. Except for the obligation of Powrmatic Ltd to perform warranty repairs during the guarantee period, Powrmatic will not be liable in respect of any claim for direct or indirect consequential losses, including loss of profits or increased cost arising from loss of use of the heater, or any event arising there from.

Exclusions

Consumables such batteries are all excluded from guarantee.

Powrmatic Ltd, Hort Bridge, Ilminster, Somerset, TA19 9PS
Tel: 01460 53535 Fax: 01460 52341
Web: www.powrmatic.co.uk e-mail: warranty@powrmatic.co.uk

Important: This certificate must be retained

SAFETY INSTRUCTIONS

IMPORTANT!

AIR CONDITIONERS MUST ALWAYS BE STORED AND TRANSPORTED UPRIGHT, OTHERWISE IRREPARABLE DAMAGE MAY BE CAUSED TO THE COMPRESSOR; IF IN DOUBT WE SUGGEST WAITING AT LEAST 24 HOURS FOLLOWING INSTALLTION BEFORE STARTING THE UNIT.

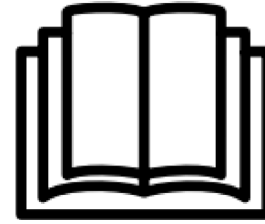

- Carefully read the instructions before installing and/or operating the unit.
- This appliance is for indoor use only.
- This unit must be only connected to a 220-240 V / 50 Hz earthed outlet.
- Installation must be in accordance with regulations of the country where the unit is used.
- If you are in any doubt about the suitability of your electrical supply have it checked and, if necessary, modified by a qualified electrician.
- This air conditioner has been tested and is safe to use. However, as with any electrical appliance - use it with care.
- Disconnect the power from the appliance before dismantling, assembling or cleaning.
- Avoid touching any moving parts of the appliance.
- Never insert fingers, pencils or any other objects though the guard.
- This appliance is not intended for use by persons (including children) with reduced physical, sensory or mental capabilities. It is also not intended for use by those with a lack of experience and knowledge, unless they have been given supervision or instruction concerning the use of the appliance by a person responsible for their safety.
- Do not leave children unsupervised with this appliance.
- Do not clean the unit by spraying it or immersing it in water.
- Never connect the unit to an electrical outlet using an extension cord. If an outlet is not available, one should be installed by a qualified electrician.
- Do not operate the unit unless it has been fully installed following the guidance provided within this manual.
- Never operate this appliance if the cord or plug is damaged. Ensure the power cord is not stretched or exposed to sharp objects/edges.
- A damaged supply cord should be replaced by the manufacturer or a qualified electrician in order to avoid a hazard.
- Any service other than regular cleaning or filter replacement should be performed by an authorised service representative. Failure to comply could result in a voided warranty.
- Do not use the appliance for any purpose other than its intended use.
- Avoid restarting the air conditioner unless 3 minutes have passed since being turned off. This prevents damage to the compressor.
- Never use the mains plug as a switch to start and turn off the air conditioner. Use the provided ON/OFF button located on the control panel.
- The appliance should not be installed in laundry or wet rooms.
- The appliance must be installed in a room without sources of ignition (for example: open flames, an operating gas appliance or an operating electric heater).
- The unit must be installed on a solid vertical wall by a competent person. The electricity supply must only be connected after installation is complete.
- R290 refrigerant gas complies with European environmental directives.

General

- R290 has a low GWP (Global Warming Potential) of 3.
- The air conditioner contains about 290g of R290 refrigerant gas.
- Do not install or store in an unventilated space with an area smaller than 15 m² per unit. The room must be such as to prevent stagnation of possible leaks of refrigerant gas as there could be a danger of fire or explosion hazard should the refrigerant come into contact with electric heaters, stoves or other sources of ignition.
- If the appliance is installed, used or stored in an unventilated room, the room must be such as to prevent stagnation of possible leaks of refrigerant gas as there could be a danger of fire or explosion should the refrigerant come into contact with electric heaters, stoves or other sources of ignition.
- Refrigerant gas may be odourless.
- Do not use the product and contact the retailer for advice, if damage has occurred to the unit which may have compromised the refrigerant system.
- Any repairs or maintenance must only be carried out on the unit by a suitably qualified engineer. Before opening and servicing the unit the authorized engineer must be in possession of a copy of the manufacturer's service manual and must follow the safety information contained within it to ensure all hazards are minimized.
- The refrigerant system should not be perforated or punctured.

Energy Saving and Unit Safety Protection Tips

- Do not cover or restrict the airflow from the outlet or inlet grills.
- Keep the filters clean . Under normal conditions , filters should only need cleaning once every three weeks (approximately) . Since the filters remove airborne particles , more frequent cleaning maybe necessary , depending on the air quality.
- For the initial start-up set the fan speed to maximum and the thermostat to 4-5 degree lower than the current temperature . After , set the fan switch to low and set the thermostat to your desired setting.
- To protect the unit , we recommend not using the cool mode when the ambient temperature is higher than 35°C.

NOTE : Some pictures and information may vary from the final product . This is due to continual product improvement.

PRODUCT OVERVIEW

PRODUCT DIAGRAM

FRONT

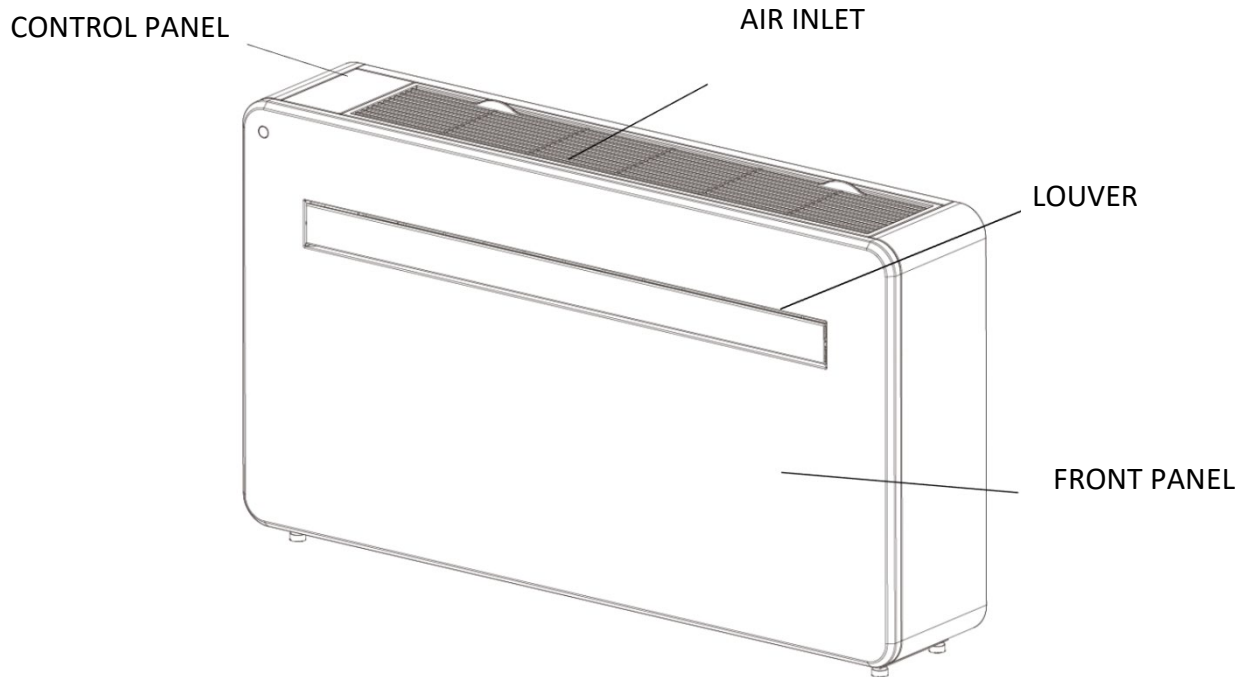

BACK

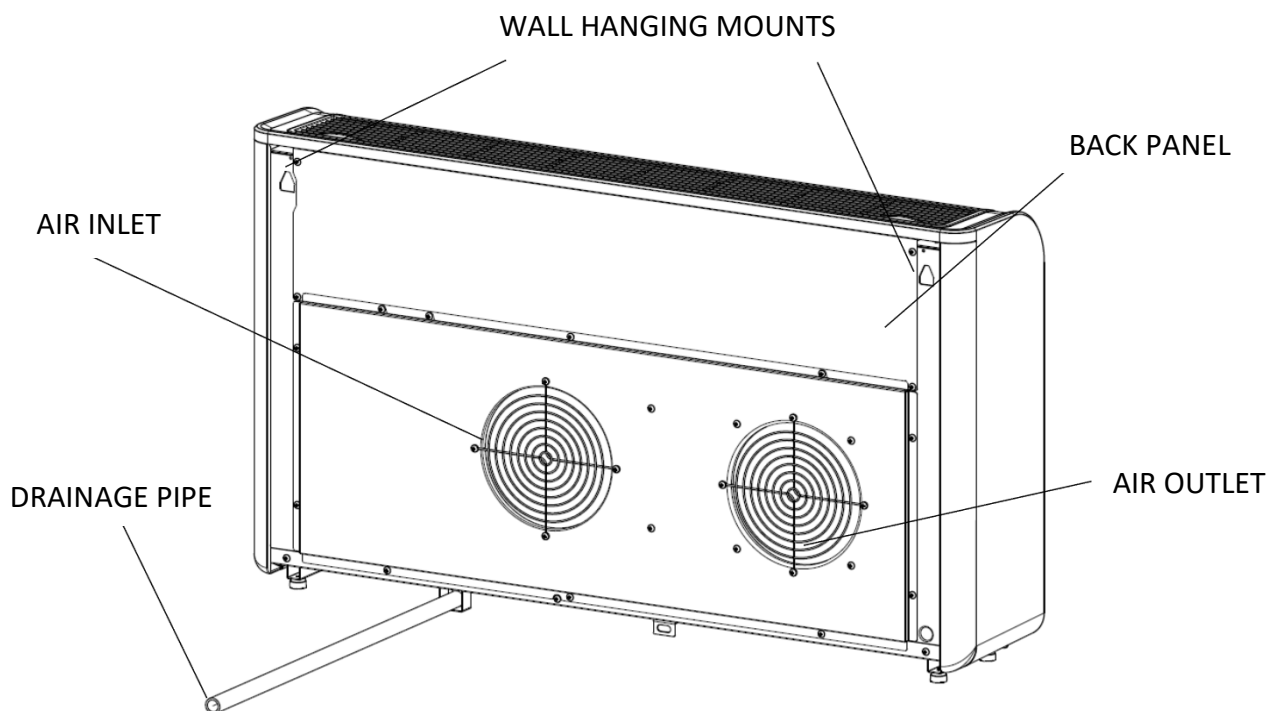

General

FEATURES

- ◆ Simple operation.
- ◆ Self-evaporative function with energy saving technology.
- ◆ Sleek design that seamlessly fits into any style home.
- ◆ Bright LED screen-indicates temperature and current mode.
- ◆ On / off timer function-allows you to choose when the unit operates.
- ◆ WIFI App control providing additional functionality.
- ◆ Three fan speeds.
- ◆ Four modes to suit your every need including : Cooling / Heating / Fan / Dry
- ◆ Silent running option , perfect for a restful night sleep.

WHATS INCLUDED

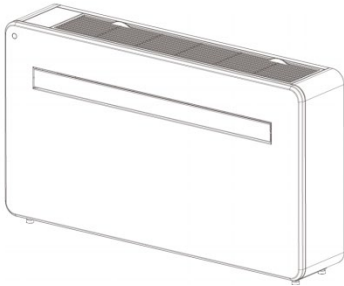

AIR CONDITIONER

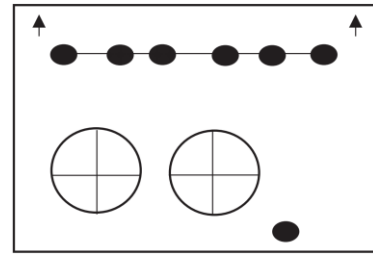

WALL TEMPLATE



7PCS SCREWS (5×60mm)



7PCS WALL PLUGS (8×40mm)



**VENT COVER ASSEMBLY (X2)
(CHAIN, INDOOR RING AND
OUTDOOR COVER)**

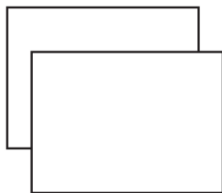

**PLASTIC DUCTING
SHEET (X2)**

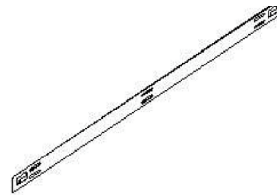

WALL BRACKET

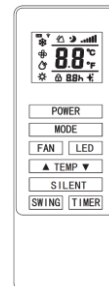

REMOTE CONTROL



FIXED PLATE

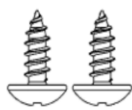

**2PCS TAPPING SCREW
(4x10mm)**

DIAGRAMS FOR ILLUSTRATIVE PURPOSES ONLY

TOOLS REQUIRED

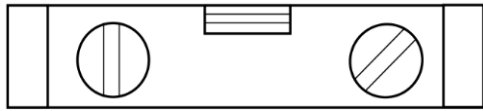

SPIRIT LEVEL

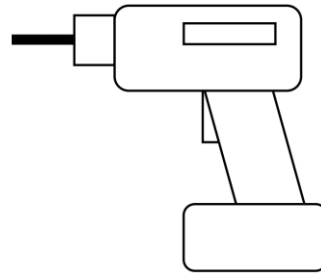

DRILL

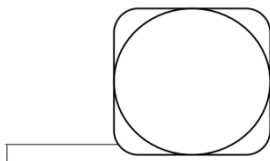

TAPE MEASURE

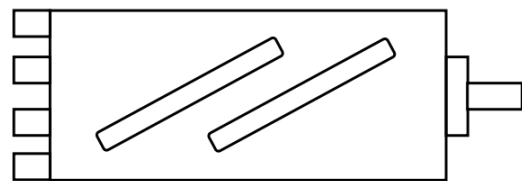

180mm CORE DRILL



8mm MASONRY DRILL

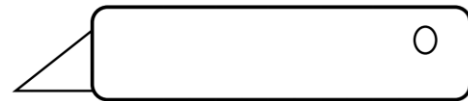

SHARP KNIFE



25mm MASONRY DRILL BIT

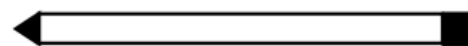

PENCIL

BEFORE STARTING INSTALLATION, PLEASE ENSURE YOU HAVE ALL SUITABLE EQUIPMENT AVAILABLE AND UNDERSTAND THE STEPS INVOLVED IN INSTALLATION. IF IN ANY DOUBT, PROFESSIONAL ADVICE SHOULD BE SOUGHT.

THE INSTALLER MUST ENSURE THAT THE PLANNED POSITION OF THE AIR CONDITIONER IS SUITABLE, AND THAT THERE ARE NO CABLES AND PIPES INSIDE THE WALL, AND NO OTHER OBSTRUCTIONS FIXED ON THE WALL, WHICH WOULD PRESENT A DANGER AND/OR PREVENT COMPLETION OF INSTALLATION.

Installation

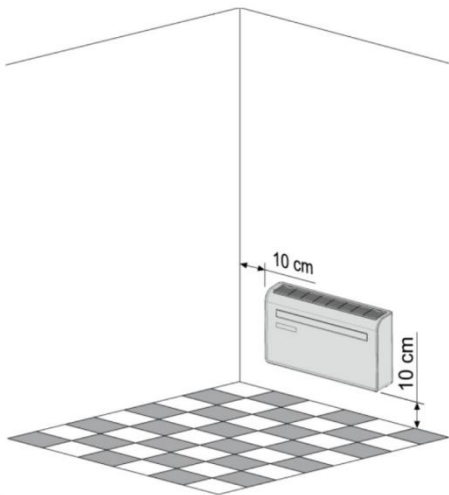

This unit must be installed on an external wall, as it vents directly out of its rear and ensure the wall is flat, solid and reliable.

Leave at least 10 cm of space to the left, right and base of the machine. At least 20cm of space must be left above the unit to help air flow smoothly and stay away from curtains, plants, faucets, furniture and others appliances etc.

Paste the supplied installation template paper in position on the wall, ensuring that the reference line is level using a spirit level.

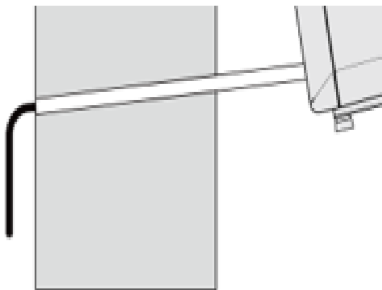
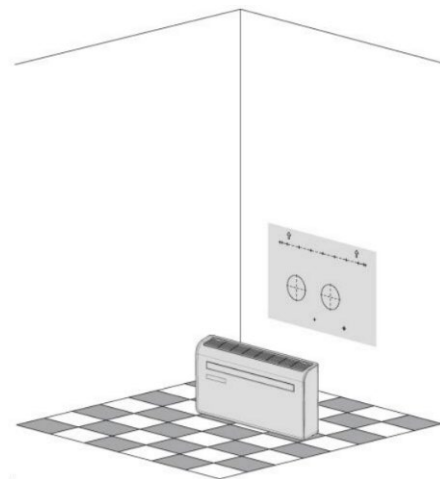

The hole for the drainage pipe must be drilled using a 25mm Drill bit. Ensure the hole is at a downward angle (min 5 degrees) so that the water will drain correctly.

Use a 180mm core drill to drill the two holes for the units ventillation, ensuring that both the holes are aligned with the template.

Use the template to mark the position of the screws for the hanging rail, using a spirit level to ensure it is straight and level. Drill the marked holes using a suitable 8mm drill bit and insert wall plugs. Line the hanging rail with the holes, and fix the rail into position using the supplied screws.

Ensure that the hanging rail is securely fastened onto the wall, and that there is no risk of the unit tipping or falling.

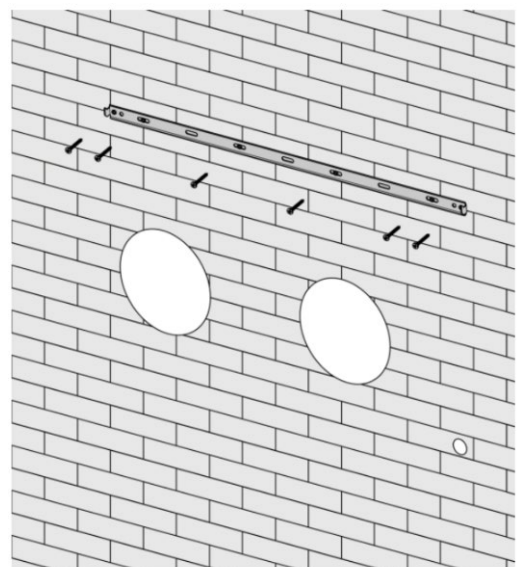

Installation

Roll the plastic vent sheets into a tube and feed them from the inside into the holes previously made. Ensure the tubes sit flush to the interior wall.

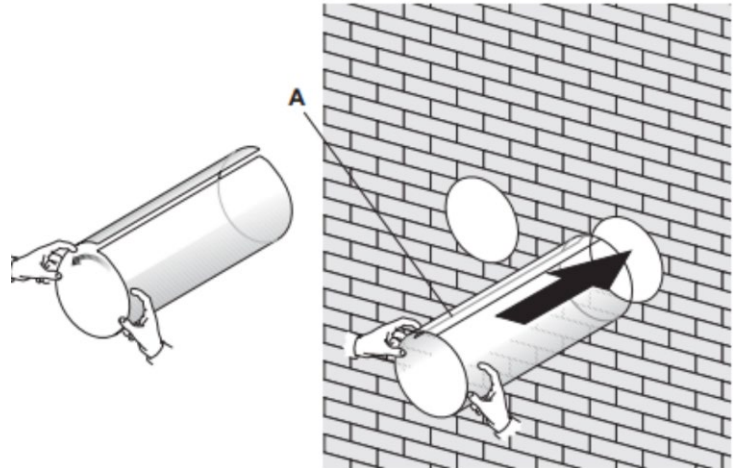
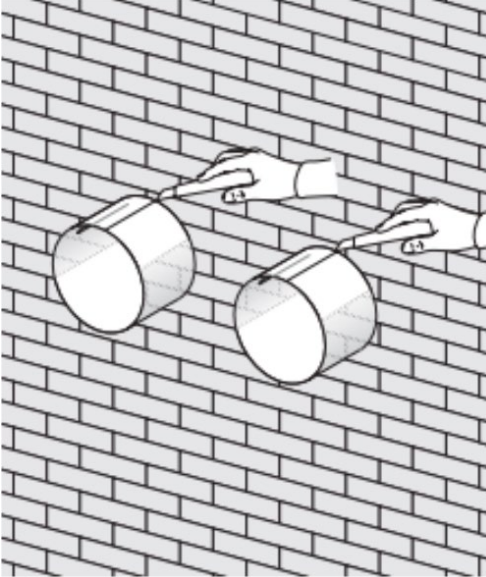

Go outside and trim off the excess vent tube using a sharp knife, keeping the edge as neat as possible.

Insert the indoor fixing ring from the vent cover onto the indoor side of the air vent. Then fold the external vent cover in half. Attach the chains to each side of the vent cover, before sliding the cover outside through the vent hole.

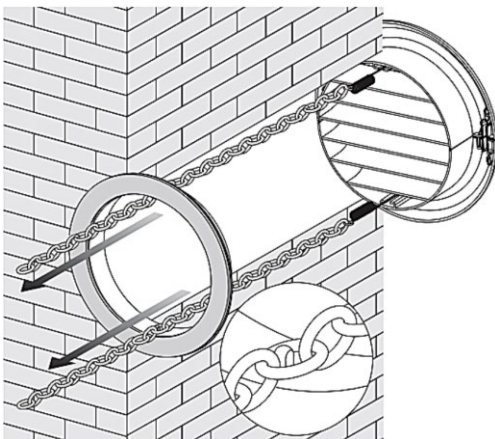
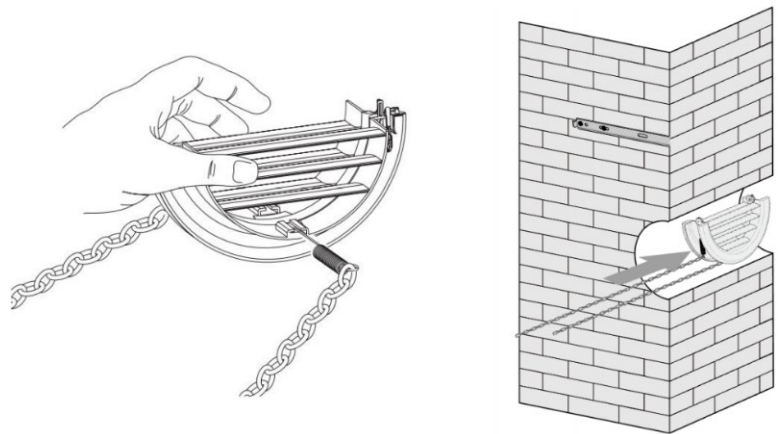

Expand the external cover, before tightly fixing the chains by hooking onto the indoor fixing ring. This will hold the external cover firmly in position. Repeat for the second vent.

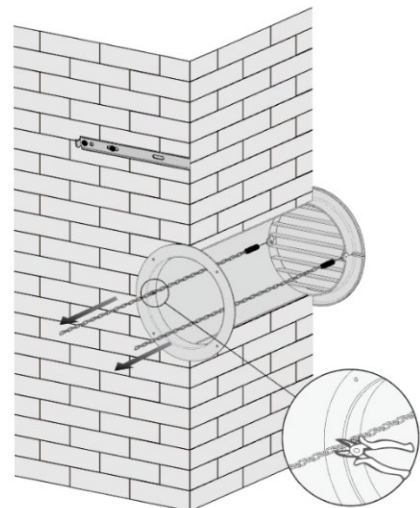

Installation

Once the chains are fitted and secure, any excess chain should be removed by cutting the chain.

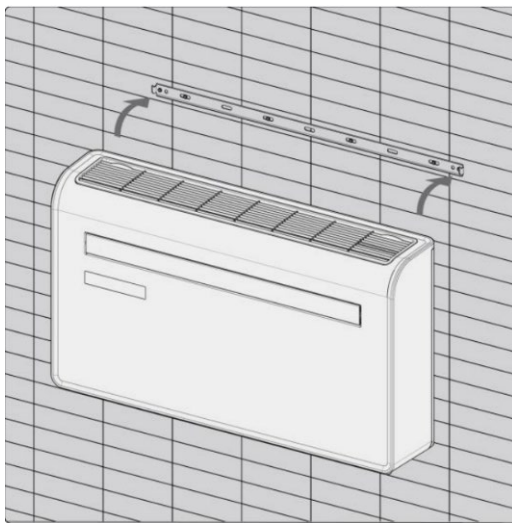

Lift the unit onto the wall, align the hanging holes with the hooks on the hanging rail and gently rest the unit into place. At the same time, slide the drain pipe through the drainage hole.

NOTE:

1st: please ensure that the backside of product is tightly attached on the wall to avoid additional vibration and noise.

2nd: The end of the external water pipe must be placed in an open space or drain. Avoid damage or constriction to the drainage pipe to ensure the unit drains.

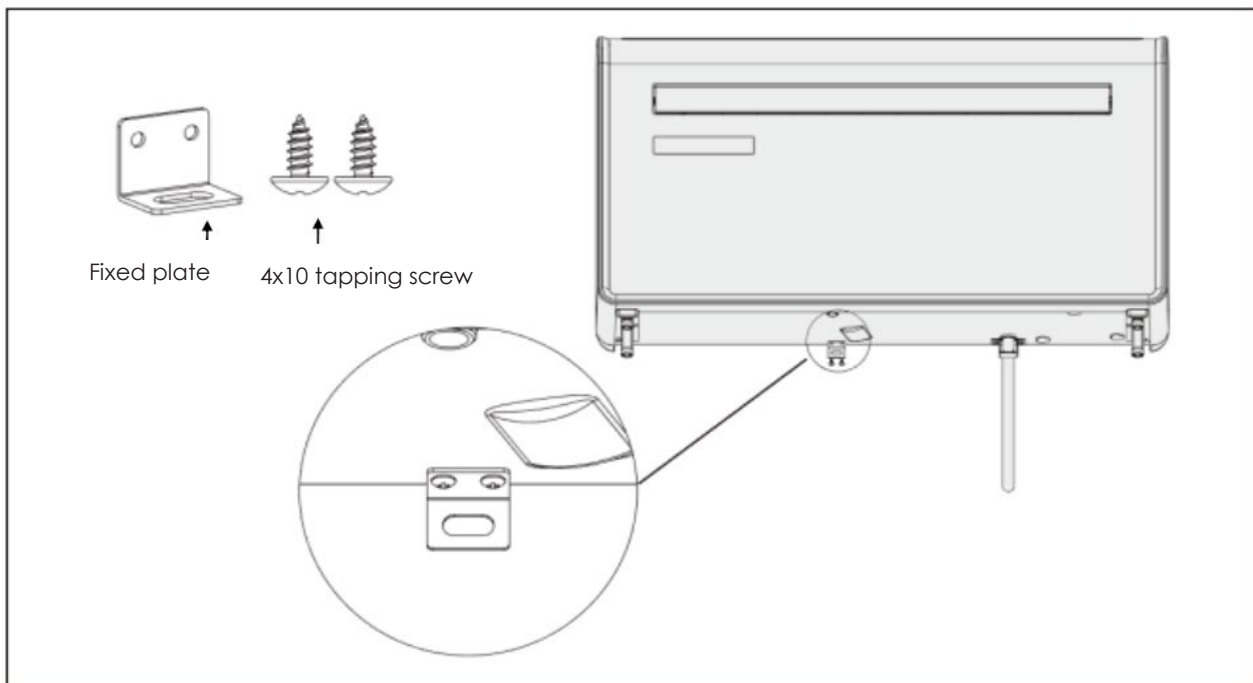

CONTROL PANEL

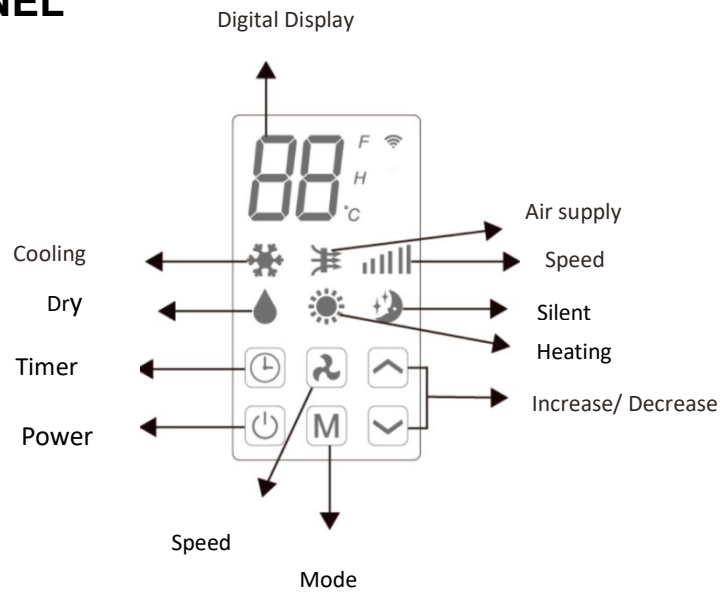

REMOTE CONTROL











The air conditioner can be controlled with the remote control. Two AAA-batteries are required.

NOTE: Further details of the functions can be found on the following page.

POWER	Press the POWER button to turn the machine on or off.	
MODE	Press the MODE button to switch between cooling, heating, fan and dry modes.	
FAN	Press the FAN button to change between high, medium and low fan speeds	
LED	Press the LED button to open or close the LED background light of unit, it can be a choice for sleep condition.	
	Press the UP button to increase the desired temperature or timer duration	
	Press the DOWN button to decrease the desired temperature or timer duration	
SILENT	Press it for silent mode, In Silent mode, noise will be lower, fan works in low speed, frequency is low.	
SWING	Press to turn the louver swing function on and off (only activated by the remote control & APP)	
TIMER	Press the TIMER button to set the automatic switch on/off.	

Operation

FUNCTIONS

 POWER	<p>Press "POWER" to turn the unit On or Off.</p>	
 MODE	<p>Press to change between the 4 different modes. The display will show the symbol for the mode currently selected.</p>	
	 COOLING	<p>The cooling function allows the air conditioner to cool the room and at the same time reduces air humidity. The desired temperature can be adjusted using the increase and decrease button between 16°C and 30°C. The fan speed can also be adjusted using the speed button.</p>
	 DRY	<p>Dry mode will extract moisture from the air, which will be drained outside using the installed drain pipe. the fan speed cannot be adjusted in dry mode.</p>
	 FAN	<p>In fan mode the appliance will recirculate the air within the room, and will not cool, heat or dehumidify. The fan speed can be adjusted using the Speed button, But the desired temperature can not be set.</p>
	 HEATING	<p>The heating function allows the air conditioner to heat the room. The desired temperature can be adjusted using the increase and decrease button between 16°C and 30°C. The fan speed can also be adjusted using the speed button.</p>
	 SILENT	<p>Silent mode can be activated from APP or the remote control, It can also be activated by pressing "🕒"+"⬆️" on unit control panel at the same time. It will only operate in cooling or heating modes, the fan speed will change to low and noise will be lower.</p>
 FAN SPEED		<p>Press to change the fan speed between Low, Medium and High. The fan speed cannot be adjusted in Dry or Silent modes.</p>
 TIMER	<p>The air conditioner contains a 24 hour timer, which can be used to either set a delayed start, or a set period of operation.</p>	
	<p>SHUTDOWN TIMER: While the unit is running press the timer button, the display will flash "0" 5 times. After the 5th flash, use the up and down buttons to adjust the duration in 1 hour increments between 1 to 24 hours. When the timer has elapsed, the unit will shutdown automatically.</p>	
<p>DELAYED START TIMER: With the unit in standby, press the timer button, the display will flash "0" 5 times. After the 5th flash, use the up and down buttons to adjust the duration in 1 hour increments between 1 to 24 hours. After the timer has elapsed, the unit will start up in the same mode with the same settings as when it was turned off.</p>		
 INCREASE AND DECREASE	<p>Used within cooling and heating modes to adjust the desired temperature 16-30°C. Also used while setting the timer to adjust the duration.</p>	
<p>SWING MODE</p>	<p>After machine turns on, press the "SWING" button, louver will swing continuously up and down; by pressing the button again the movement will stop and the louver remain in that position. Swing mode can only be adjusted from the remote, and will initially be turned on by default. the louver will close automatic once switch OFF the product.</p>	

COMPRESSOR PROTECTION	There is a 3 minutes delay on power on. In order to protect the life of the compressor and electronic components please do not switch on the unit for at least 5 minutes after you turned the unit off.
------------------------------	---

WIFI SETUP AND SMART FEATURES

WIFI SETUP

BEFORE YOU START

- Ensure your router provides a standard 2.4ghz connection.
- If your router is dual band ensure that both networks have different network names (SSID). The provider of your router / Internet service provider will be able to provide advice specific to your router.
- Place the air conditioner as close as possible to the router during setup.
- Once the app has been installed on your phone, turn off the data connection, and ensure your phone is connected to your router via WIFI.

DOWNLOAD THE APP TO YOUR PHONE

Download the "SMART LIFE" app, from your chosen app store, using the QR codes below, or by searching for the app in your chosen store.



CONNECTION METHODS AVAILABLE FOR SETUP

The air conditioner has two different setup modes, Quick Connection and AP connection (Access Point). The quick connection is a quick and simple way to set the unit up. The AP connection uses a direct local WIFI connection between your phone and the air conditioner to upload the network details.

In Standby mode press and hold the speed button for 3 seconds (until you hear a bleep) to enter the wifi connection mode.

Please ensure your device is in the correct wifi connection mode for the connection type you are attempting, the flashing of the wifi light on your air conditioner will indicate this.

Connection Type	Frequency of Flashes
Quick Connection	Flashes twice per second
AP Connection (Access Point)	Flashes once per three seconds

Operation

CHANGING BETWEEN CONNECTION TYPES

To change the unit between the two wifi connection modes, hold the Speed button for 3 seconds.

REGISTER THE APP

1. Press on the register button at the bottom of the screen.

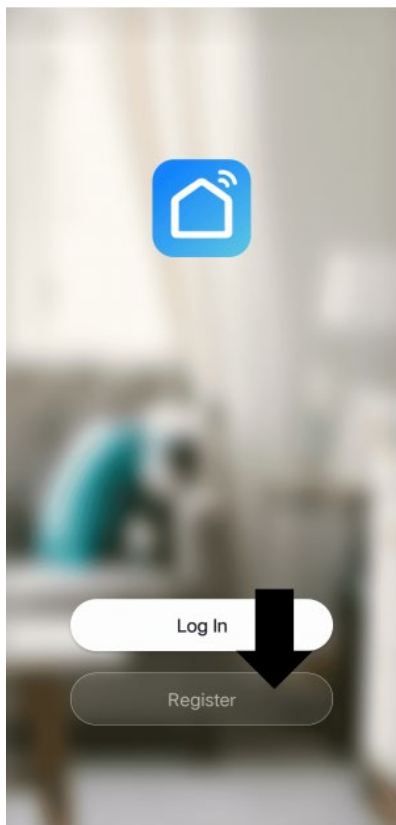

2. Read the Privacy policy and press the Agree Button.

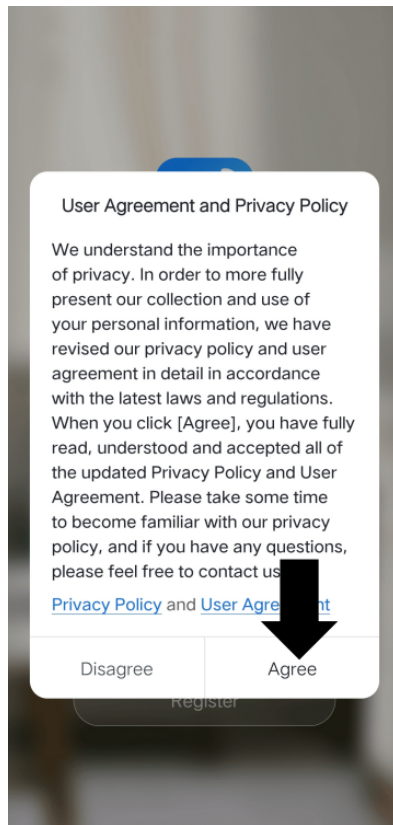

3. Enter your email address or phone number and press continue to register.

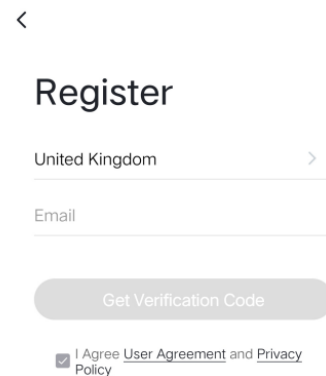

4. A verification code will be sent by the method selected in step 3. Enter the code into the app.

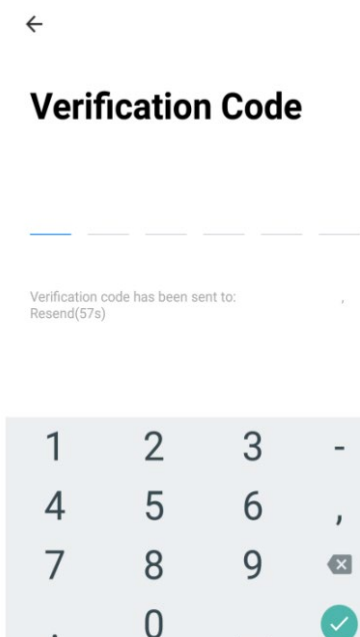

5. Type in the password you would like to create. This needs to be 6-20 characters, with letters and numbers.

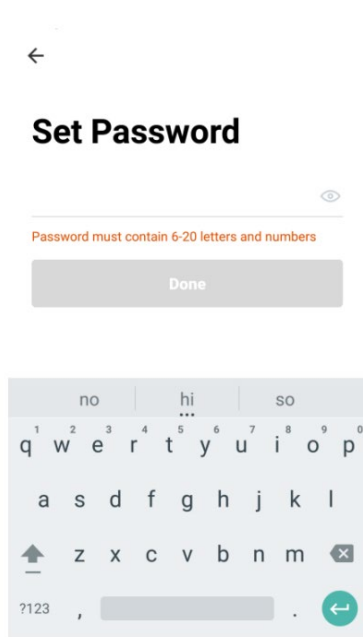

6. The app is now registered. It will automatically log you in following registration.

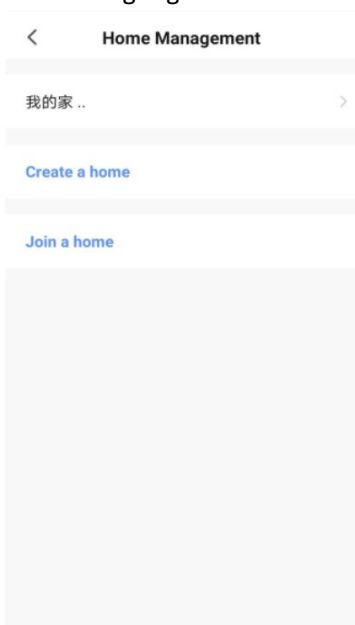

SETTING UP YOUR HOME WITHIN THE APP

SMART LIFE is designed so it can work with a large number of compatible smart devices within your home. It can also be set up to work with multiple devices within different houses. As such during the setup process, the app requires that different areas are created and named to allow easy management of all your devices. When new devices are added, they are assigned to one of the rooms you have created.

CREATING ROOMS

1. Press on the create a home button.

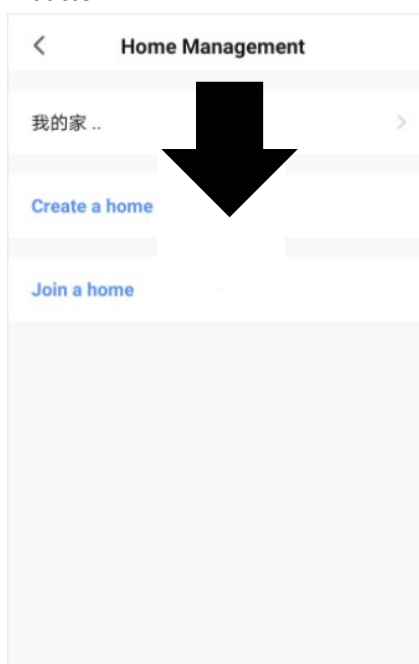

2. Type in a name for your home.

3. Press “home location” button to select the location of your home. (See SETTING YOUR LOCATION below)

4. New rooms can be added by pressing the ADD ROOM option at the bottom. (See ADD ANOTHER ROOM below). And untick any rooms that are not required on the app, then Press SAVE in the top right corner.

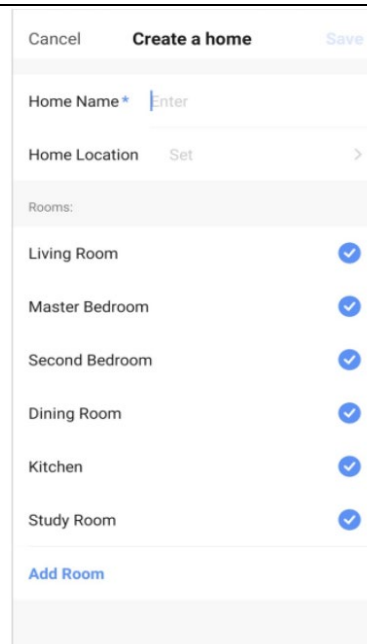

SETTING YOUR LOCATION

Use your finger to move the orange HOME symbol.

When the symbol is in the approximate location of your home, press the confirm button in the top right corner.

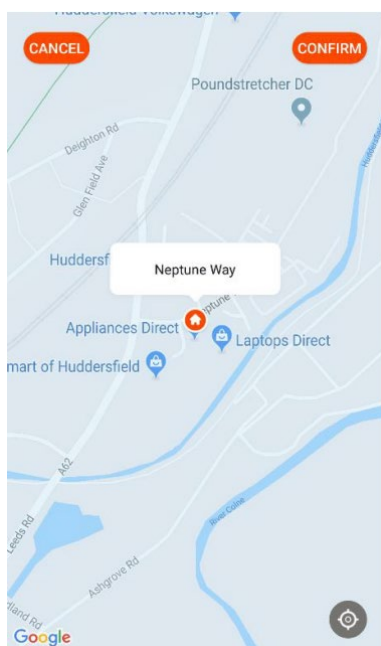

ADD ANOTHER ROOM

Type in the name of the room, and press Done in the top right corner.

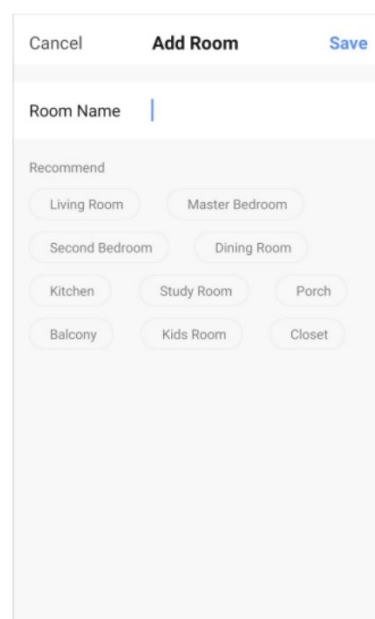

Operation

CONNECTING USING QUICK CONNECTION

Before initiating the connection, make sure the unit is in standby mode, with the WIFI light flashing twice per second. If not follow the instructions for changing the connection mode. Also ensure your phone is connected to the wifi network. (We advise turning mobile data off during setup)

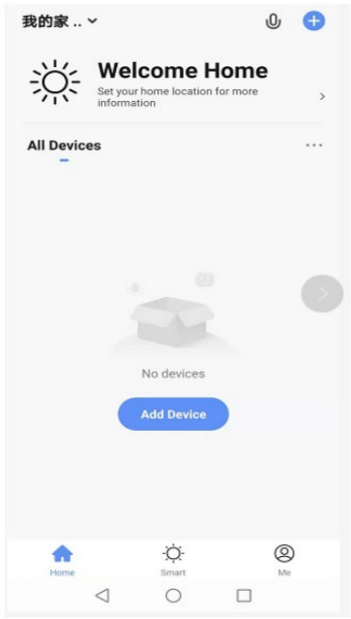
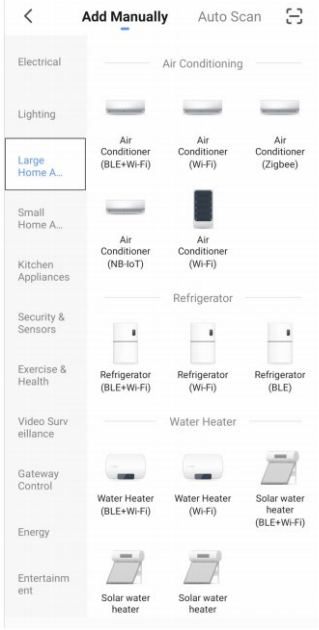
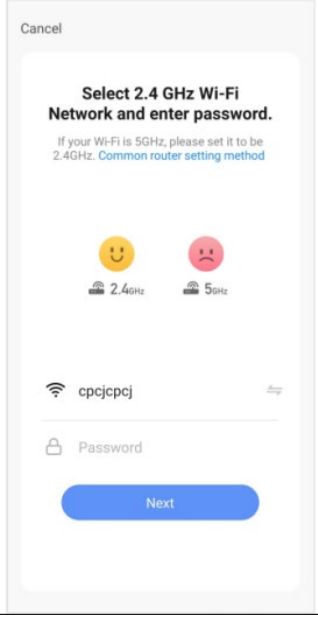
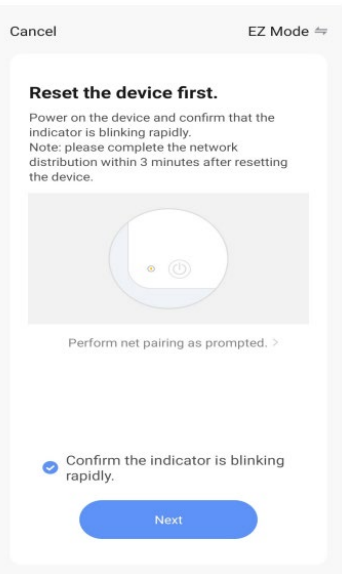
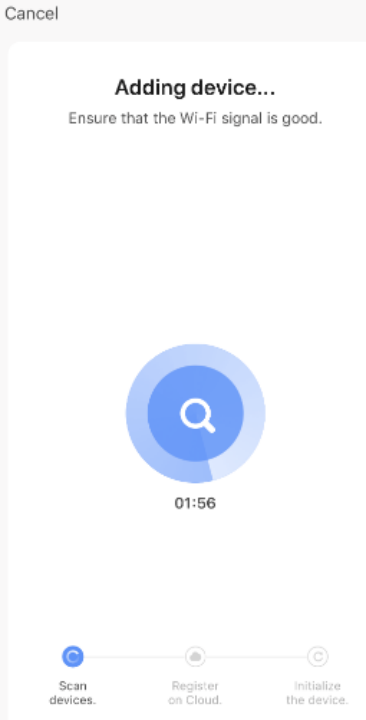
<p>1. Open app and press “+” to add device, or use the add device button.</p> 	<p>2. Select the type of device as “Large Home Appliance”</p> 	<p>3. Connect a WIFI and enter the password.</p> 
<p>4. Ensure the WIFI light on the air conditioner is flashing twice per second, then click NEXT button to enter the next setting.</p> 	<p>5. Click NEXT button to scan and connect a new device. Waiting for this process to complete.</p> <p>6. Please retry if this fails. please review the troubleshooting section for further help if still unsuccessful</p>	

CONNECTING USING AP MODE (ALTERNATIVE METHOD)

Before initiating the connection, make sure the unit is in standby mode, with the wifi light flashing once per three seconds. If not follow the instructions for changing the wifi connection mode. Also ensure your phone is connected to the wifi network. (We advise turning mobile data off during setup)

- 1) Open app and press “+” to add device, or use the add device button.

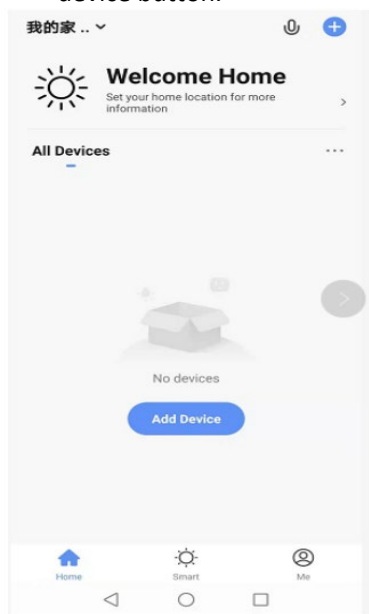

- 2) Select the type of device as “Large Home Appliance”

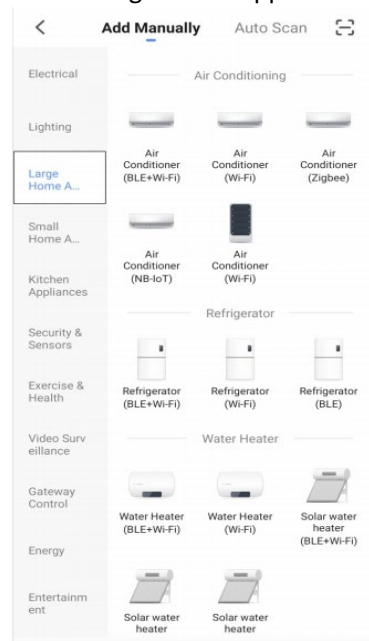

- 3) Enter your wifi password and press confirm.

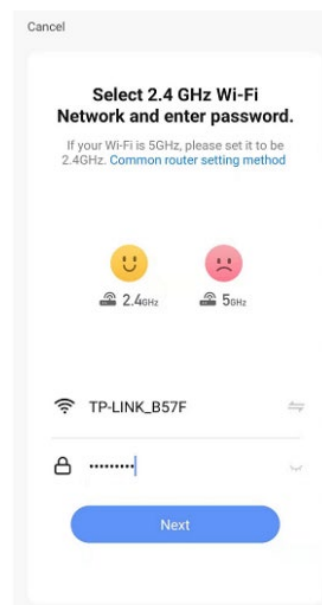

- 4) Change to the AP mode in the top right of the screen.

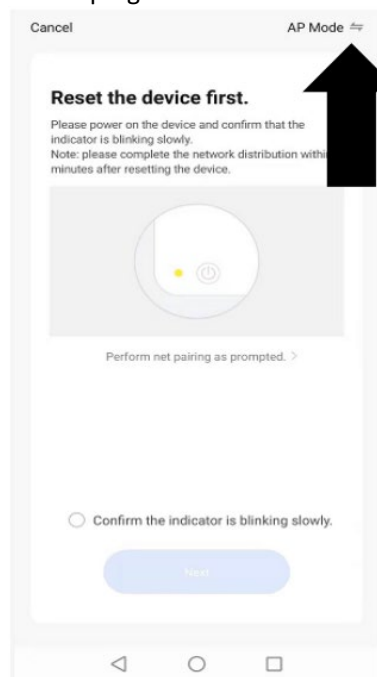

- 5) Ensure the wifi light on the air conditioner is slowly flashing (once per three seconds), then click NEXT button to enter the next setting.

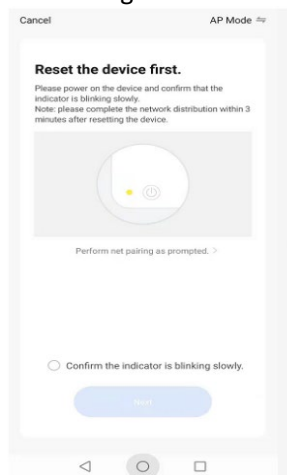

- 6) Get into network settings in your phone and connect to the “Smart Life xxx” connection. There is no password to enter. Then return back to the app to complete setup.

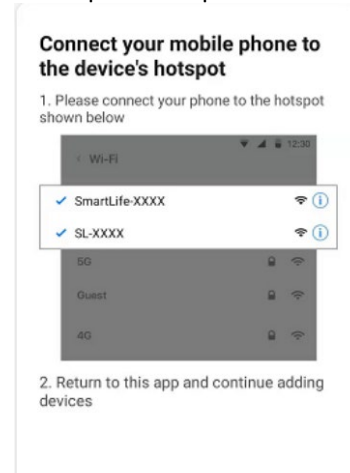

Once the connection process has completed, go back to the network settings on your phone to ensure your phone has reconnected to your WIFI router.

Operation

CONTROLLING YOUR DEVICE THROUGH THE APP

THE HOME SCREEN

Change Home: You can change between them if you created more than one home.

Environmental information: shown outdoor temperature and humidity based on the location details.

Smart Scene: Allows you to program intelligent behaviour based on the internal and external environment.

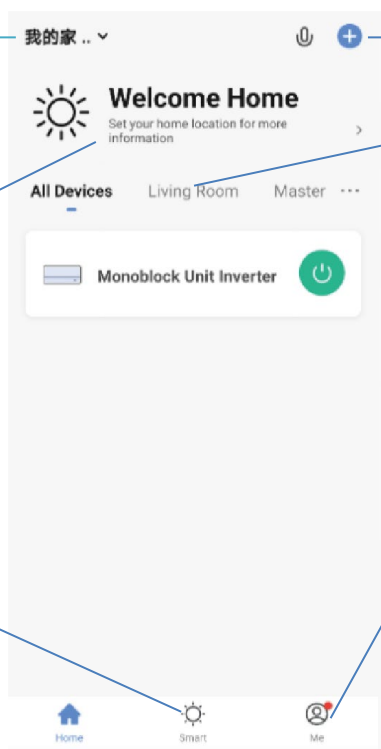

Add Device: Add new device on the APP, and go through the setup process.

Room Management: Use to view the units set up within each room. And Allows rooms to be added, removed or renamed.

Me: Provides the option for changing settings.

Each device has its own entry on the home screen to allow the user to either quickly turn the unit on or off, or to enter the device screen to make other changes.

DEVICE SCREEN

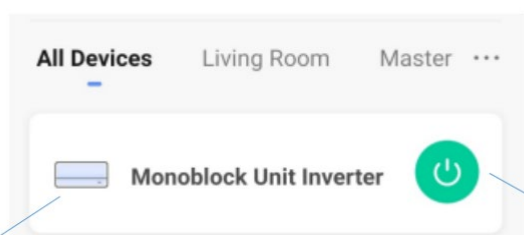

Name of Air Conditioner: Click to enter the Device Screen.

ON / OFF Button: Click to quickly turn on or off the device.

DEVICE SCREEN

The device screen is the main control screen for the air conditioner, providing access to the controls to amend the functions and settings.

The screenshot shows the 'Monoblock Unit Inverter' app interface. At the top, there are back and forward navigation arrows. The main display area shows 'Temp Current 19°C' and a large '18' with a degree symbol and a small 'F' below it. Below the temperature are icons for different modes: sun, fan, swing, timer, and schedule. At the bottom, there are five icons: MODE, FAN, SWING, Timer, and Schedule. In the center, there are minus and plus signs for temperature adjustment, and a large circular 'OFF' button. A moon icon is also visible on the left side of the bottom section.

Back: Returns to the Home Screen

Edit Name: Use to change the name of the air conditioner.

Current Room Temperature: Displays the current room temperature.

Desired Room Temperature: Displays the desired room temperature.

MODE: Change the operating mode of the air conditioner between Cooling , Heating ,Dehumidify and Fan.

Current Mode: Shows the mode the air conditioner is currently in.

SWING: Use to turn the oscillating swing function on and off.

SCHEDULE: Use to add a set a scheduled operation . A number of these can be combined to specify automatic operation.

SPEED: Use to change the Fan speed between Low, Medium and High. Note this cannot be changed in dehumidify mode.

TIMER: Use to add an off timer while the unit is running , or an on timer while the unit is turned off

Desired Temperature and timer decreasing

Desired Temperature and timer increasing

SILENT: Use to set SILENT mode, the speed of upper and lower fans will be set to LOW speed. In SILENT mode temperature and speed cannot be changed, press the button again will switch SILENT mode off.

ON / OFF Button: Switch ON/OFF device

***Due to continuous development of the app, the layout and available features may be subject to change.**

Operation

SMART SCENES

Smart Scenes is a powerful tool providing the option to customise the operation of the air conditioner based both on conditions within the room and outside influences. This gives the user the option of specifying much more intelligent actions. These are split into two categories Scene and Automation.

SCENE

Scene allows for a one touch button to be added to the Home screen. The button can be used to change a number of settings in one go, and can change all the settings within the unit. A number of scenes can easily be setup, allowing the user to easily change between a number of preset configurations.

Below is an example of how to set up a scene:

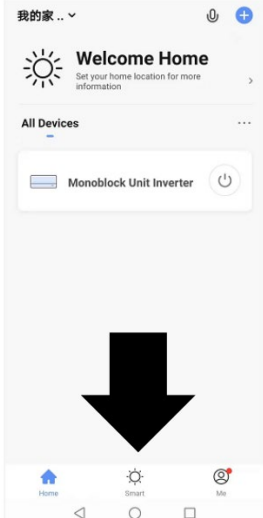
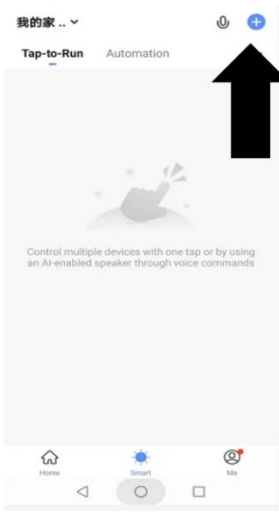
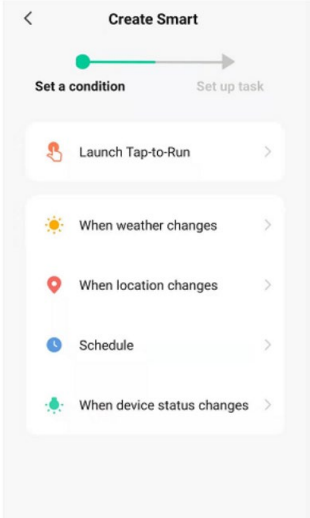
<p>1. Press on the Smart Scene tab at the bottom of the Home screen.</p> 	<p>2. Press on the Plus in the top right corner to add a smart scene.</p> 	<p>3. Press on the Launch Tap-to-Run to create a new Scene.</p> 
---	--	--

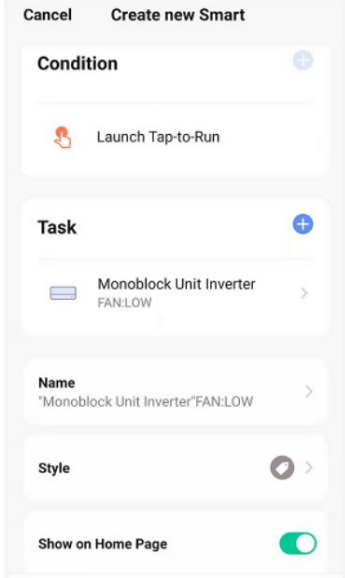
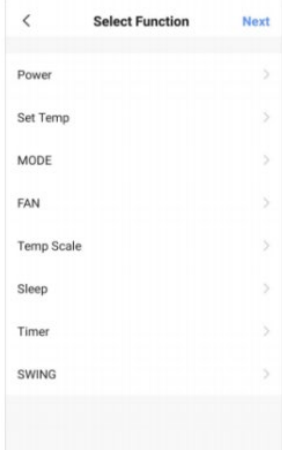

	<p>4. Press the arrow next to “Name” to input the name for your Scene</p> <p>Show on Home Page: Leave this on if you require the scene to be displayed as a button on the Home Screen</p> <p>Press the Blue Plus to add the action required. Then select the air conditioner from the list of devices.</p>	<p>5. Chose the function, set the value for the function, and then press the arrow button in the top left corner, to return to the previous screen.</p> 
<p>6. Once all the functions required have been added, press the Save button in the top right corner to finalise and save your new Scene.</p>		

AUTOMATION

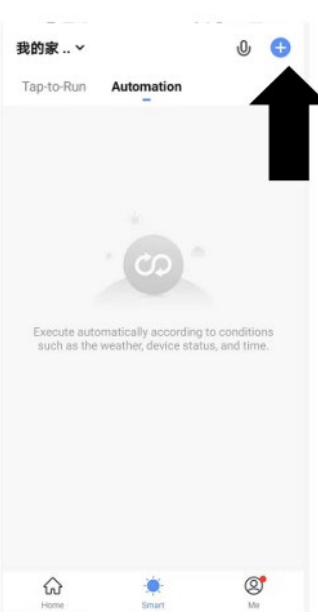
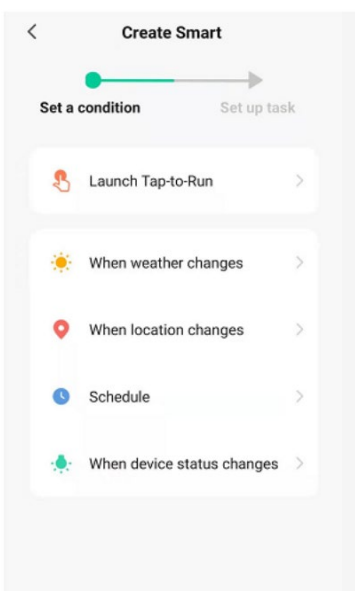
Automation allows an automatic action to be set up for the device. This can be triggered by the Time, indoor temperature, humidity of the room, weather conditions, and a range of other influences.

<p>1. Press on the Smart Scene tab at the bottom of the Home screen.</p> 	<p>2. Press on the Plus in the top right corner to add a smart scene.</p> 	<p>3. Press on the Launch Tap-to-Run to create a new Scene.</p> 
--	---	---

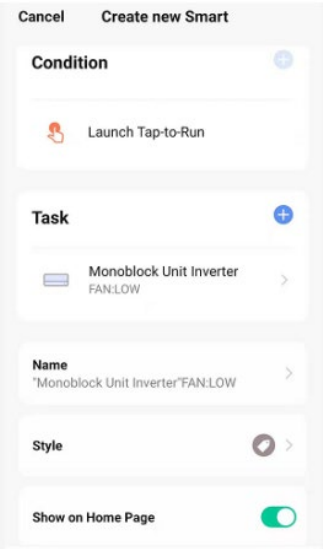
Operation

	<p>4. Setup is very similar to the scene setup on the previous page, and includes an extra section for specifying a trigger for the scene to start.</p> <p>Press the arrow next to “Name” to input the name for your Scene</p> <p>Show on Home Page: Leave this on if you require the scene to be displayed as a button on the Home Screen</p> <p>Press the Blue Plus to add the action required. Then select the air conditioner from the list of devices.</p>	<p>5. Chose the function, set the value for the function, and then press the arrow button in the top left corner, to return to the previous screen.</p>
<p>6. Chose the function, and then press the arrow button in the top left corner, to return to the previous screen.</p>		

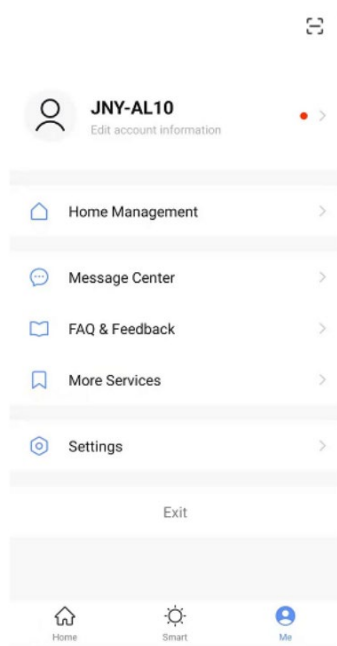

ME

The profile tab gives you the option to edit both your detail, and use the added features of the unit.

CHANGING THE NAME OF YOUR DEVICE

When in any of the device screens further settings for the device can be accessed, by pressing on the three dots in the top right hand corner. The top option within this allows you to change the name of the device to something relevant to the use of the product, such as “Living Room Air Conditioner”. Within the menu, you also have the option of setting up a pattern lock or change your password.

DEVICE SHARING

This allows you to share access to the controls of your air conditioner with friends and family.

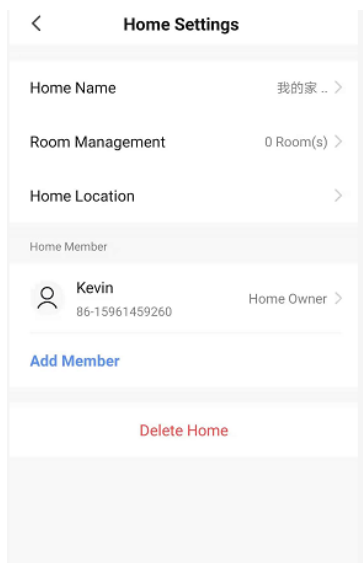

In page “Home Management”, select “My home”, you could “Add Member” there to share access to the controls of your air conditioner with friends and family, please refer to the left picture.

INTEGRATION

This allows the unit to be integrated with your favourite home automation hardware such as Google Home and the Amazon Echo.

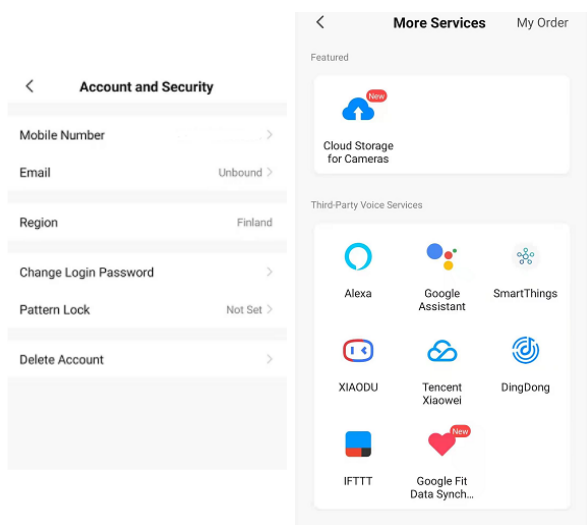

Select “More Services”, you could integrate with third-party voice services, pls refer to the left picture.

Operation

TROUBLESHOOTING

Do not repair or disassemble the air conditioning. Unqualified repair will invalidate the warranty and may lead to failure, causing injuries and property damage. Only use it as directed in this user manual and only perform operations advised here.

Problem	Reasons	Solutions
The air conditioner does not work	There is no electricity.	Check the unit is plugged in, and the socket is working normally.
	The ambient temperature is too low or too high.	Only use to use the machine with a room temperature between 7 and 35°C.
	In cooling mode, the room temperature is lower than the desired temperature; in heating mode, the room temperature is higher than the desired temperature.	Adjust the desired room temperature.
	In dehumidification (dry) mode, the ambient temperature is low.	Ensure that the room temperature is above 17°C for dry mode.
	There is direct sunlight.	Use curtains to reduce heat from the sun.
The cooling or heating effect is poor	Doors or windows are open; there are a lot of people; or in cooling mode, there are other sources of heat (e.g. fridges)	Close doors and windows; increase air conditioning power
	The filters screen is dirty.	Clean or replace the filter screen.
	The air inlet or outlet is blocked.	Clear obstructions; make sure the unit is installed as per the instructions
The air conditioner is leaking	The unit is not straight	Use a spirit level to check the unit is horizontal, if not remove from the wall and Straighten.
	The drain pipe is blocked	Check the drain pipe to ensure it is not blocked or constricted.
Compressor does not work.	Overheat protection operational .	Wait for 3 minutes until the temperature is lowered, and then restart the machine.
The remote control does not work.	The remote control is not aligned with the direction of the remote-control receiver.	Let the remote control get close to the air conditioner, and make sure that the remote control directly faces to the direction of the remote-control receiver.
	Batteries poor.	Replace batteries.

If problems not listed in the table occur or recommended solutions do not work, please contact the service centre.

ERROR CODES

Fault Code	Fault Description	Fault Code	Fault Description
F1	Compressor IPM error	P6	Coil tube overload protection
F2	PFC/IPM error	P7	Defrost protection on coil tube
F3	Compressor start error	P8	Zero-crossing fault detection
F4	Compressor running out of step	PA	Return air sensor temperature abnormal protection
F5	Location detection loop failure	PE	Abnormal refrigerant circulation
F6	PCB communication error	PH	Exhaust temperature protection
F8	Sensor on suction pipe error	E0	Sensor on suction pipe error
FA	Phase current overcurrent protection	E1	Temperature sensor error
FL	Water-full protection	E2	Sensor error on indoor coil tube
P1	Over-heat protection on top of compressor	E3	DC fan Feedback failure
P2	Dc bus voltage Undervoltage protection	E5	Water-splash motor error
P3	AC Input voltage protection	E8	Fan feedback fault
P4	AC over-current protection	EE	EE error
P5	AC undervoltage protection		

Service and Operation for the Flammable Refrigerants R290

Please read this user's manual carefully to ensure proper use, maintenance and installation

WARNING (for R290)

Before Initiation

- Thoroughly read all of the warnings.
- Use only implements recommended by the manufacturer for defrosting or cleaning.
- Do not pierce or burn.
- R290 is a refrigerant gas that complies with the European directives on the environment. Do not perforate any of the components in the refrigerant circuit. Refrigerant gas may be odorless.
- If the appliance is installed, operated or stored in an unventilated area, the room must be designed to prevent to the accumulation of refrigerant leaks resulting in a risk of fire or explosion due to ignition of the refrigerant caused by electric heaters, stoves, or other sources of ignition.
- Individuals who operate or work on the refrigerant circuit must have the appropriate certification issued by an accredited organization that ensures competence in handling refrigerants according to a specific evaluation recognized by associations in the industry.
- All repairs must be carried out in accordance with the manufacturer' s recommendations. Maintenance and repairs requiring the assistance of other qualified personnel must be carried out under the supervision of specialists in the use of inflammable refrigerants.
- Do not exceed impedance greeter than 0.1 ohm in supply the appliance is connected to. Failure to comply may lead the supply authority to impose restrictions to connection. Please consult your energy supply authority if the use of equipment exceeds 0.1 ohm.

GENERAL SAFETY INSTRUCTION

- Keep the unit upward while transport and storage, for the compressor locates properly.
- Before cleaning the air-conditioner, always turn off or disconnect the power supply.
- When moving the air-conditioner, always turn off and disconnect the power supply, and move it slowly.
- To avoid the possibility of fire disaster, the air-conditioner shall not be covered.
- Details of type and rating of fuses: T15AH, 250V AC.
- Contact authorized service technician for repair or maintenance of this unit.
- Do not pull , deform . or modify the power supply cord , or immerse it in water . Pulling or misuse of the power supply cord can result in damage to the unit and cause electrical shock.
- That compliance with national gas regulations shall be observed.
- A warning to keep any required ventilation openings clear of obstruction.
- Any person who is involved with working on or breaking into a refrigerant a refrigerant circuit should hold a current valid certificate from an industry-accredited assessment authority. Which authorizes their competence to handle refrigerants safety in accordance with an industry recognized assessment specifications.
- Do not operate or stop the unit by inserting or pulling out Die power plug, it may cause electric shock or fire due to heat generation .

- Unplug the unit if strange sounds, smell, or smoke comes from it.



**R290 refrigerant gas complies with European environmental directives.
This appliance contains approximately 290g of R290 refrigerant gas
Appliance shall be installed, operated and stored in a room with a floor area larger than 15 m².**

INSTRUCTION, REPAIRING APPLIANCES CONTAINING R290

1. Checks to the area

Prior to beginning work on systems containing flammable refrigerants, safety checks are necessary to ensure that the risk of ignition is minimized. For repair to the refrigerating system, the following precaution shall be completed prior to conducting work on the system.

2. Work procedure

Work shall be undertaken under a controlled procedure so as to minimize the risk of a flammable gas or vapor being present while the work is being performed.

3. General work area

All maintenance staff and others working in the local area shall be instructed on the nature of work being carried out. Work in confined spaces shall be avoided.

4. Checking for presence of refrigerant

The area shall be checked with an appropriate refrigerant detector prior to and during work, to ensure the technician is aware of potentially toxic or flammable atmospheres.

Ensure that the leak detection equipment being used is suitable for use with all applicable refrigerants, i.e. nonsparking, adequately sealed or intrinsically safe.

5. Presence of fire extinguisher

If any hot work is to be conducted on the refrigerating equipment or any associated parts, appropriate fire extinguishing equipment shall be available to hand. Have a dry powder or CO₂ fire extinguisher adjacent to the charging area.

6. No ignition sources

No person carrying out work in relation to a refrigerating system which involves exposing

any pipe work shall use any sources of ignition in such a manner that it may lead to the risk of fire or explosion. All possible ignition sources, including cigarette smoking, should be kept sufficiently far away from the site of installation, repairing, removing and disposal, during which refrigerant can possibly be released to the surrounding space. Prior to work taking place, the area around the equipment is to be surveyed to make sure that there are no flammable hazards or ignition risks. “No Smoking” signs shall be displayed.

7. Ventilated area

Ensure that the area is in the open or that it is adequately ventilated before breaking into the system or conducting any hot work. A degree of ventilation shall continue during the period that the work is carried out. The ventilation should safely disperse any released refrigerant and preferably expel it externally into the atmosphere.

8. Checks to the refrigerating equipment

Where electrical components are being changed, they shall be fit for the purpose and to the correct specification. At all times the manufacturer’s maintenance and service guidelines shall be followed. If in doubt, consult the manufacturer’s technical department for assistance.

The following checks shall be applied to installations using flammable refrigerants:

- the actual refrigerant charge is in accordance with the room size within which the refrigerant containing parts are installed;
- the ventilation machinery and outlets are operating adequately and are not obstructed;
- if an indirect refrigerating circuit is being used, the secondary circuit shall be checked for the presence of refrigerant;
- marking to the equipment continues to be visible and legible. Markings and signs that are illegible shall be corrected;
- refrigerating pipe or components are installed in a position where they are unlikely to be exposed to any substance which may corrode refrigerant containing components, unless the components are constructed of materials which are inherently resistant to being corroded or are suitably protected against being so corroded.

9. Checks to electrical devices

Repair and maintenance to electrical components shall include initial safety checks and component inspection procedures. If a fault exists that could compromise safety, then no electrical supply shall be connected to the circuit until it is satisfactorily dealt with. If the fault cannot be corrected immediately but it is necessary to continue operation, an adequate temporary solution shall be used. This shall be reported to the owner of the equipment so all parties are advised.

Initial safety checks shall include:

- that capacitors are discharged: this shall be done in a safe manner to avoid possibility of sparking;
- that no live electrical components and wiring are exposed while charging, recovering or purging the system;
- that there is continuity of earth bonding.

10. Repairs to sealed components

During repairs to sealed components, all electrical supplies shall be disconnected from the equipment being worked upon prior to any removal of sealed covers, etc. If it is absolutely necessary to have an electrical supply to equipment during servicing, then a permanently operating form of leak detection shall be located at the most critical point to warn of a potentially hazardous situation.

Particular attention shall be paid to the following to ensure that by working on electrical components, the casing is not altered in such a way that the level of protection is affected. This shall include damage to cables, excessive number of connections, terminals not made to original specification, damage to seals, incorrect fitting of glands, etc.

Ensure that the apparatus is mounted securely.

Ensure that seals or sealing materials have not degraded to the point that they no longer serve the purpose of preventing the ingress of flammable atmospheres. Replacement parts shall be in accordance with the manufacturer's specifications.

NOTE: The use of silicon sealant may inhibit the effectiveness of some types of leak detection equipment. Intrinsically safe components do not have to be isolated prior to working on them.

11. Repair to intrinsically safe components

Do not apply any permanent inductive or capacitance loads to the circuit without ensuring that this will not exceed the permissible voltage and current permitted for the equipment in use.

Intrinsically safe components are the only types that can be worked on while live in the presence of a flammable atmosphere. The test apparatus shall be at the correct rating.

Replace components only with parts specified by the manufacturer. Other parts may result in the ignition of refrigerant in the atmosphere from a leak.

12. Cabling

Check that cabling will not be subject to wear, corrosion, excessive pressure, vibration, sharp edges or any other adverse environmental effects. The check shall also take into account the effects of aging or continual vibration from sources such as compressors or fans.

13. Detection of flammable refrigerants

Under no circumstances shall potential sources of ignition be used in the searching for or detection of refrigerant leaks. A halide torch (or any other detector using a naked flame) shall not be used.

14. Leak detection methods

The following leak detection methods are deemed acceptable for systems containing flammable refrigerants. Electronic leak detectors shall be used to detect flammable refrigerants, but the sensitivity may not be adequate, or may need recalibration. (Detection equipment shall be calibrated in a refrigerant-free area.) Ensure that the detector is not a potential source of ignition and is suitable for the refrigerant used. Leak detection equipment shall be set at a percentage of the LFL of the refrigerant and shall be calibrated

to the refrigerant employed and the appropriate percentage of gas (25 % maximum) is confirmed. Leak detection fluids are suitable for use with most refrigerants but the use of detergents containing chlorine shall be avoided as the chlorine may react with the refrigerant and corrode the copper pipe-work. If a leak is suspected, all naked flames shall be removed/extinguished. If a leakage of refrigerant is found which requires brazing, all of the refrigerant shall be recovered from the system, or isolated (by means of shut off valves) in a part of the system remote from the leak. Oxygen free nitrogen (OFN) shall then be purged through the system both before and during the brazing process.

15. Removal and evacuation

When breaking into the refrigerant circuit to make repairs – or for any other purpose – conventional procedures shall be used. However, for flammable refrigerants it is important that best practice is followed since flammability is a consideration. The following procedure shall be adhered to:

- remove refrigerant;
- purge the circuit with inert gas;
- evacuate;
- purge with inert gas;
- open the circuit by cutting or brazing.

The refrigerant charge shall be recovered into the correct recovery cylinders. For appliances containing flammable refrigerants the system shall be purged with oxygenfree nitrogen to render the appliance safe for flammable refrigerants. This process may need to be repeated several times. Compressed air or oxygen shall not be used for purging refrigerant systems.

For appliances containing flammable refrigerants, refrigerants purging shall be achieved by breaking the vacuum in the system with oxygen-free nitrogen and continuing to fill until the working pressure is achieved, then venting to atmosphere, and finally pulling down to a vacuum. This process shall be repeated until no refrigerant is within the system. When the final oxygen-free nitrogen charge is used, the system shall be vented down to atmospheric pressure to enable work to take place. This operation is absolutely vital if brazing operations on the pipe-work are to take place.

Ensure that the outlet for the vacuum pump is not close to any potential ignition sources and that ventilation is available.

16. Charging procedures

In addition to conventional charging procedures, the following requirements shall be followed.

- Ensure that contamination of different refrigerants does not occur when using charging equipment. Hoses or lines shall be as short as possible to minimise the amount of refrigerant contained in them.
- Cylinders shall be kept in an appropriate position according to the instructions.
- Ensure that the refrigerating system is earthed prior to charging the system with refrigerant.
- Label the system when charging is complete (if not already).

- Extreme care shall be taken not to overfill the refrigerating system. Prior to recharging the system, it shall be pressure-tested with the appropriate purging gas. The system shall be leaktested on completion of charging but prior to commissioning. A follow up leak test shall be carried out prior to leaving the site.

17. Decommissioning

Before carrying out this procedure, it is essential that the technician is completely familiar with the equipment and all its detail. It is recommended good practice that all refrigerants are recovered safely. Prior to the task being carried out, an oil and refrigerant sample shall be taken in case analysis is required prior to re-use of recovered refrigerant. It is essential that electrical power is available before the task is commenced.

- a) Become familiar with the equipment and its operation.
- b) Isolate system electrically.
- c) Before attempting the procedure, ensure that:
 - mechanical handling equipment is available, if required, for handling refrigerant cylinders;
 - all personal protective equipment is available and being used correctly;
 - the recovery process is supervised at all times by a competent person;
 - recovery equipment and cylinders conform to the appropriate standards.
- d) Pump down refrigerant system, if possible.
- e) If a vacuum is not possible, make a manifold so that refrigerant can be removed from various parts of the system.
- f) Make sure that cylinder is situated on the scales before recovery takes place.
- g) Start the recovery machine and operate in accordance with instructions.
- h) Do not overfill cylinders (no more than 80 % volume liquid charge).
- i) Do not exceed the maximum working pressure of the cylinder, even temporarily.
- j) When the cylinders have been filled correctly and the process completed, make sure that the cylinders and the equipment are removed from site promptly and all isolation valves on the equipment are closed off.
- k) Recovered refrigerant shall not be charged into another refrigerating system unless it has been cleaned and checked.

18. Labelling

Equipment shall be labelled stating that it has been decommissioned and emptied of refrigerant. The label shall be dated and signed. For appliances containing flammable refrigerants, ensure that there are labels on the equipment stating the equipment contains flammable refrigerant.

19. Recovery

When removing refrigerant from a system, either for servicing or decommissioning, it is recommended good practice that all refrigerants are removed safely.

When transferring refrigerant into cylinders, ensure that only appropriate refrigerant recovery cylinders are employed. Ensure that the correct number of cylinders for holding the total system charge is available. All cylinders to be used are designated for the recovered refrigerant and labelled for that refrigerant (i.e. special cylinders for the recovery

of refrigerant). Cylinders shall be complete with pressure-relief valve and associated shut-off valves in good working order. Empty recovery cylinders are evacuated and, if possible, cooled before recovery occurs.

The recovery equipment shall be in good working order with a set of instructions concerning the equipment that is at hand and shall be suitable for the recovery of all appropriate refrigerants including, when applicable, flammable refrigerants. In addition, a set of calibrated weighing scales shall be available and in good working order. Hoses shall be complete with leak-free disconnect couplings and in good condition. Before using the recovery machine, check that it is in satisfactory working order, has been properly maintained and that any associated electrical components are sealed to prevent ignition in the event of a refrigerant release. Consult manufacturer if in doubt.

The recovered refrigerant shall be returned to the refrigerant supplier in the correct recovery cylinder, and the relevant waste transfer note arranged. Do not mix refrigerants in recovery units and especially not in cylinders.

If compressors or compressor oils are to be removed, ensure that they have been evacuated to an acceptable level to make certain that flammable refrigerant does not remain within the lubricant. The evacuation process shall be carried out prior to returning the compressor to the suppliers. Only electric heating to the compressor body shall be employed to accelerate this process. When oil is drained from a system, it shall be carried out safely.

Getting In Touch

Powrmatic Limited
Hort Bridge, Ilminster
Somerset
TA19 9PS
tel: **+44 (0) 1460 53535**
fax: **+44 (0) 1460 52341**
e-mail: **info@powrmatic.co.uk**
web: **www.powrmatic.co.uk**



Powrmatic Ireland
45 Broomhill Close
Tallaght
Dublin 24
tel: **+353 (0) 1452 1533**
fax: **+353 (0) 1452 1764**
e-mail: **info@powrmatic.ie**
web: **www.powrmatic.ie**



Powrmatic pursues a policy of continuous improvement in both design and performance of its products and therefore reserves the right to change, amend or vary specifications without notice. Whilst the details contained herein are believed to be correct they do not form the basis of any contract and interested parties should contact the Company to confirm whether any material alterations have been made since publication of this brochure.