

**POWRMATIC®**

# Verticool

Installation & Servicing Manual

Issue 1.5 Apr 2026

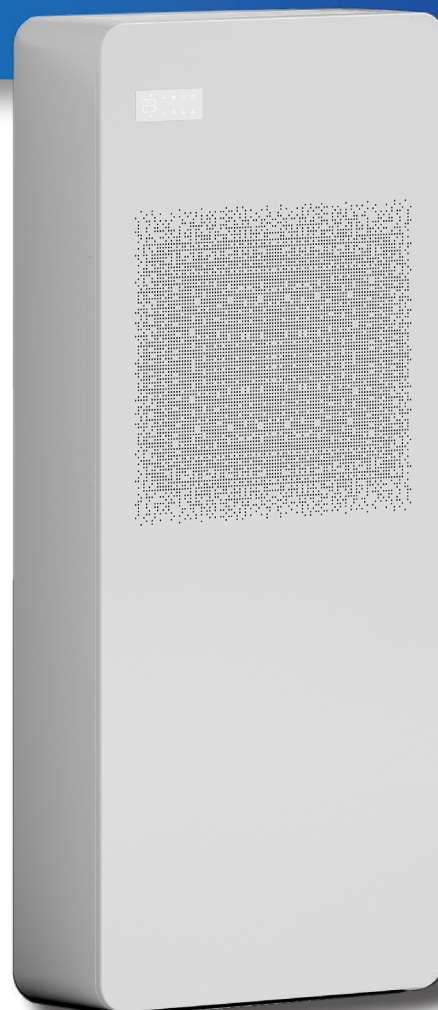



Dear Customer - thank you for choosing Powrmatic.

We appreciate you buying one of our high quality products and know that you have made the best choice. By choosing Powrmatic, you are investing in UK manufacturing & its workforce. We pride ourselves by manufacturing products that provide clean, comfortable and safe working environments worldwide together with the personal & professional service and back-up you deserve. If you have any questions or concerns regarding this product, please contact our Technical Support Team by calling 01460 53535.

This booklet consists of 56 pages.

## Conformity

This unit complies with the European directives:

- EN 60335-2-40 Household and similar electrical appliances - Safety Part 2-40: Particular requirements for electrical heat pumps, air-conditioners and dehumidifiers
- Low voltage 2014/35/EU
- EMC 2014/30/EU
- RED 2014/53/EU on the harmonisation of the laws of the Member States relating to the making available on the market of radio equipment
- RoHS 2011/65/UE
- 2017/1369/EU on energy labelling
- 2009/125/CE implementing regulation 206/2012/EU and Italian implementing regulation Legislative Decree no. 15 of 16/02/2011

And subsequent amendments.

 For declarations of conformity, certificates and other certification details please consult the website.

## Markings



## TABLE OF CONTENTS

<b>1. Coding</b> . . . . .	<b>5</b>	<b>6.4 Connections</b> . . . . .	<b>34</b>
1.1 Product related coding . . . . .	5	<b>6.5 Basic menu</b> . . . . .	<b>35</b>
<b>2. General information</b> . . . . .	<b>6</b>	<b>6.6 Advanced Menu</b> . . . . .	<b>36</b>
2.1 About the manual . . . . .	6	<b>6.7 Alarm display on wall control panel</b> . . .	<b>37</b>
2.2 General warnings . . . . .	7	<b>7. M7 Series Commands EFB749</b> . . . . .	<b>38</b>
2.3 Basic rules of security . . . . .	8	7.1 Interface . . . . .	38
2.4 Disposal . . . . .	8	7.2 Installation . . . . .	39
<b>3. Product presentation</b> . . . . .	<b>10</b>	7.3 Single connection diagram . . . . .	41
3.1 Identification . . . . .	10	7.4 Multiple connection diagram . . . . .	42
3.2 Destination of use . . . . .	10	7.5 Connections . . . . .	43
3.3 Description of the appliance . . . . .	10	7.6 Functions . . . . .	44
3.4 Components . . . . .	11	<b>8. Maintenance</b> . . . . .	<b>47</b>
3.5 Compatible accessories . . . . .	12	8.1 Preliminary warnings . . . . .	47
<b>4. Installation</b> . . . . .	<b>13</b>	8.2 Routine maintenance . . . . .	47
4.1 Preliminary warnings . . . . .	13	<b>9. Troubleshooting</b> . . . . .	<b>49</b>
4.2 Reception . . . . .	13	9.1 Troubleshooting table . . . . .	49
4.3 Dimensions and weights with packaging	14	9.2 Diagnosis of possible anomalies . . . . .	49
4.4 Handling with packaging . . . . .	14	9.3 Visualization of alarms on display . . . . .	50
4.5 Storage . . . . .	14	<b>10. Technical information</b> . . . . .	<b>51</b>
4.6 Unpacking . . . . .	15	10.1 Technical data . . . . .	51
4.7 Handling without packaging . . . . .	16	10.2 Dimensions . . . . .	52
4.8 Installation site . . . . .	16	10.3 Installation template . . . . .	53
4.9 Installation minimum distances . . . . .	17	10.4 Safety . . . . .	53
4.10 Positioning . . . . .	17	10.5 RED Compliance Statement . . . . .	53
4.11 Condensation drain preparation . . . . .	20	10.6 FCC Declaration of Conformity . . . . .	53
4.12 Electric connections . . . . .	22		
4.13 Operations after installation . . . . .	24		
4.14 Disassembly and assembly of cosmetic panels and grilles . . . . .	24		
<b>5. Touchpad and remote control</b> . . . . .	<b>26</b>		
5.1 Interface . . . . .	26		
5.2 Basic menu . . . . .	26		
5.3 Advanced Menu . . . . .	27		
5.4 Visualization of alarms on display . . . . .	29		
<b>6. M7 series control EEB749</b> . . . . .	<b>30</b>		
6.1 Interface . . . . .	30		
6.2 Installation . . . . .	31		
6.3 Single connection diagram . . . . .	33		

## 1. CODING

### 1.1 Product related coding

This instruction manual refers to the following product codes.





 Check the correspondence with the technical rating plate on the product. See chapter "Identification" *p. 10*.

<b>..2.0 Verticale</b>	
C020000135	..2.0 Verticale 12 HP
C020000123	..2.0 Verticale 15 HP
<b>..2.0 Verticale ELEC</b>	
C020000130	..2.0 Verticale ELEC 15 HP

## 2. GENERAL INFORMATION

### 2.1 About the manual





This manual was written to provide all the explanations for the correct management of the device.

-  This instruction manual forms an integral part of the device and therefore must be carefully preserved and must ALWAYS travel with it, even if you transfer the device to another owner or relocate it to other premises. If the manual gets damaged or lost, download a copy from the website.
-  Read this manual carefully before proceeding with any operation and follow the instructions in the individual chapters.
-  The Manufacturer accepts no liability for damages to persons or property caused by failure to follow the instructions in this manual.
-  This document is restricted in use to the terms of the law and may not be copied or transferred to third parties without the express authorisation of the Manufacturer.

#### 2.1.1 Editorial pictograms

The pictograms in the next chapter provide the necessary information for correct and safe use of the machine in a rapid and unmistakable way.

#### Related to security

-  **High risk warning (bold text)**
  - The operation described above presents a risk of serious physical injury, fatality, major damage to the device and/or to the environment if not carried out in compliance with safety regulations.
-  **Low risk warning (plain text)**
  - The operation described above presents a risk of minor physical injury or minor damage to the device and/or to the environment if not carried out in compliance with safety regulations.
-  **Prohibition (plain text)**
  - Refers to prohibited actions.
-  **Important information (bold text)**
  - This indicates important information that must be taken into account during the operations.



#### In the texts

- ▶ procedures
- lists

#### In the control panels

- ▶ actions required  
*Expected responses following an action.*

#### In the figures

- 1 The numbers indicate the individual components.
- A The capital letters indicate component assemblies.
-  The white numbers in black marks indicate a series of actions to be carried out in sequence.
-  The black letter in white identifies an image when there are several images in the same figure.

#### 2.1.2 Pictograms on the product

Symbols are used in some parts of the device:

#### Related to security



##### Read instruction manual

- Read the instructions carefully before performing any work on the device.



##### Instruction manual

- Read the information available in the technical documentation of the device.



##### Caution: electrical danger

- The concerned personnel is informed to the presence of electricity and the risk of suffering an electric shock.

#### 2.1.3 Recipients

##### User

Non-expert person capable of operating the product in safe conditions for people, for the product itself and the environment, interpreting an elementary diagnostic of faults and abnormal operating conditions, carrying out simple adjustment, checking and maintenance operations.

##### Installer

Expert person qualified to position and connect (hydraulically, electrically, etc.) the unit to the plant; this person is responsible for handling and correct installation according to the instructions provided in this manual and the national standards currently in force.

To work on the refrigeration circuit, the installer must comply with the provisions of Regulation 303/2008/EC which defines, in accordance with Directive 842/2006/EC, the requirements for companies and personnel with regard to fixed refrigeration, air conditioning and heat pump equipment containing certain fluorinated greenhouse gases (F-gas licence).

##### Authorized Service Center

Expert and qualified person authorised directly by the manufacturer to carry out all routine and supplementary maintenance operations, as well as every adjustment,

check, repair and replacement of parts necessary during the life of the unit itself.

Service personnel must comply with the provisions of Regulation 303/2008/EC which defines, in accordance with Directive 842/2006/EC, the requirements for companies and personnel with regard to fixed refrigeration, air conditioning and heat pump equipment containing certain fluorinated greenhouse gases (F-gas licence).

## 2.1.4 Manual organization

The manual is divided into sections each dedicated to one or more target groups.

### Coding

It addresses all recipients.

It contains the list of products and/or accessories referred to in the manual.

### General information

It addresses all recipients.

It contains general information and important warnings that should be known before installing and using the device.

### Product presentation

It addresses all recipients.

It contains the information to identify the product, its components, compatible accessories and destination of use.

### Installation

It is addressed exclusively to the installer.

It contains specific warnings and all the information necessary for positioning, mounting and connecting the appliance.

### Commissioning, maintenance and troubleshooting

They are addressed exclusively to the Authorized Service Center.

It contains specific warnings useful information for the most common commissioning and routine maintenance.

### Technical information

It addresses all recipients.

It contains detailed technical information about the appliance.

## 2.2 General warnings

- ⚠ Specific warnings are given in each chapter of the document and must be read before starting operations.
- ⚠ All personnel involved must be aware of the operations and dangers that may arise when beginning all unit installation operations.
- ⚠ Installation performed outside the warnings provided in this manual and use of the appliance outside the prescribed temperature limits will invalidate the warranty.
- ⚠ The installation and maintenance of climate control equipment could be dangerous because there is pressurised refrigerant gas and live electrical components inside the appliances. The installation and subsequent maintenance phases must be carried out exclusively by authorised and qualified personnel.
- ⚠ Any contractual or extra-contractual liability for damage caused to persons, animals or property, due to installation adjustment and maintenance errors, or improper use, is excluded. All uses not expressly indicated in this manual are not permitted.
- ⚠ Only suitably qualified installers are authorized to install the device. After having completed installation, the installer will issue a declaration of conformity to the plant manager, as required by the applicable standards and the guidelines provided by contractor's instruction manual supplied with the device.
- ⚠ First start-up and repair or maintenance operations must be carried out by the Technical Assistance Center or by qualified personnel following the provisions of this manual.
- ⚠ Do not modify or tamper with the appliance as this can lead to dangerous situations.
- ⚠ Use suitable personal protective clothing and equipment during installation and/or maintenance operations. The Manufacturer is not liable for the non-observance of the current safety and accident prevention regulations.
- ⚠ Do not use any means or tools to accelerate the defrosting process or for cleaning other than those recommended by the manufacturer.
- ⚠ The appliance must be stored in a room without sources of injection in continuous operation (e.g. open flames, a gas appliance in operation or an electric heater in operation).
- ⚠ In the event of liquid or oil leaks, set the main switch of the plant to "OFF" and isolate water taps where applicable. Call the Authorized Service Center or professionally qualified personnel as soon as possible and do not work on the appliance yourself.
- ⚠ In case of replacement of parts, use only original parts.
- ⚠ The Manufacturer reserves the right to make changes to its models at any time to improve its product, without prejudice to the essential characteristics described in this manual. The manufacturer is not obliged to add such modifications to machines previously manufactured, already delivered or under construction.
- ⚠ The unit can be used by children over the age of 8, and by people with reduced physical, sensory or mental capabilities, or with no experience or necessary knowledge, as long as they are monitored or after they have received instructions on the safe use of the unit and have understood the dangers involved. Children must not play with the appliance. The cleaning and maintenance that must be performed by the user should not be carried out by children without supervision.

# General

## 2.2.1 Specific warnings for R32

- i** This document contains only some of the warnings related to the refrigerant R32. For more comprehensive information, carefully read the safety data sheet available from the dealer.
- ⚠** Each chapter contains specific warnings for the operations it describes. These warnings must be read before starting activities.
- ⚠** All precautions concerning the treatment of the refrigerant must be observed following the regulations in force.

- ⚠** The unit uses environmentally friendly R32 refrigerant gas, with a Global Warming Potential (GWP) = 675. Do not release R32 gas into the atmosphere.
- ⚠** R32 refrigerant gas is mildly flammable and odourless.
- ⚠** Do not place flammable objects (spray cans) within 1 metre of the air outlet.
- ⚠** Avoid proximity to sources of ignition in continuous operation (open flames, gas appliances, electric stoves, lighted cigarettes, etc.).
- ⚠** If refrigerant gas escapes, ventilate the room abundantly and leave. Call the Authorised Service Centre or professionally qualified personnel as soon as possible and do not intervene on the appliance yourself.

## 2.3 Basic rules of security

Please keep in mind that the use of products powered by electricity and water call for operators to comply with certain essential safety rules:

- ⊖** The use of the appliance by children and unassisted disabled persons is prohibited.
- ⊖** It is forbidden to touch the device with wet or damp body parts.
- ⊖** It is forbidden to carry out any operation before disconnecting the appliance from the power supply by setting the plant main switch to "OFF".
- ⊖** It is forbidden to modify the safety or adjustment devices, or adjust without authorization and indications of the Manufacturer.
- ⊖** It is forbidden to pull, unplug or twist the device's electric cables, even if it is disconnected from the mains.
- ⊖** It is forbidden to introduce objects and substances through the air inlet and outlet grilles.

- ⊖** It is forbidden to open the access doors of the device's internal parts without first having set main switch of the system to "OFF".
- ⊖** It is forbidden to incorrectly dispose of the packaging, or leave in the reach of children, which may become a source of danger.

### 2.3.1 Specific safety rules for R32

**This document contains only some of the safety rules related to refrigerant R32. For more comprehensive information, carefully read the safety data sheet available from the dealer.**

- ⊖** Smoking in the vicinity of the appliance is prohibited.
- ⊖** Using a mobile phone near the appliance is prohibited.
- ⊖** Using leak detectors with halogen lamps is prohibited.

## 2.4 Disposal



The symbol on the product or packaging indicates that the product must not be treated as normal household waste, but must be taken to the appropriate collection point for recycling of used electrical and electronic equipment and batteries.

Proper disposal of this product avoids harm to humans and the environment and promotes the reuse of valuable raw materials.

For more detailed information about the recycling of this product, contact your local authority, your household waste disposal service or the shop where you purchased the product.

Illegal disposal of the product by the user involves the application of the administrative sanctions provided for by the regulations in force.

This provision is valid in the EU Member States.

- ⚠** Avoid disassembling the unit yourself.
- ⚠** This unit contains fluorinated greenhouse gases covered by the Kyoto Protocol. Maintenance and disposal operations must be carried out by qualified personnel only.
- ⚠** **Contact an Authorized Service Center to disassemble the appliance.**



This symbol might be used in combination with a chemical symbol.  
In this case, it complies with the requirement set by the Directive for the chemical involved.

## 3. PRODUCT PRESENTATION

### 3.1 Identification

The appliance can be identified by the rating plate:

#### Technical rating plate

- ⚠ According to EU Regulation No. 517/2014 concerning certain fluorinated greenhouse gases, it is mandatory to indicate the total amount of refrigerant present in the installed system. This information can be found on the rating plate of the unit.
- ⚠ Tampering with, removal of, or lack of identification plates will not allow for the safe identification of the product by its serial number and therefore invalidates the warranty.
- ⚠ For removing the cover panels and grilles, refer to chapter "Disassembly and assembly of cosmetic panels and grilles" *p. 25*.

1. Technical rating plate

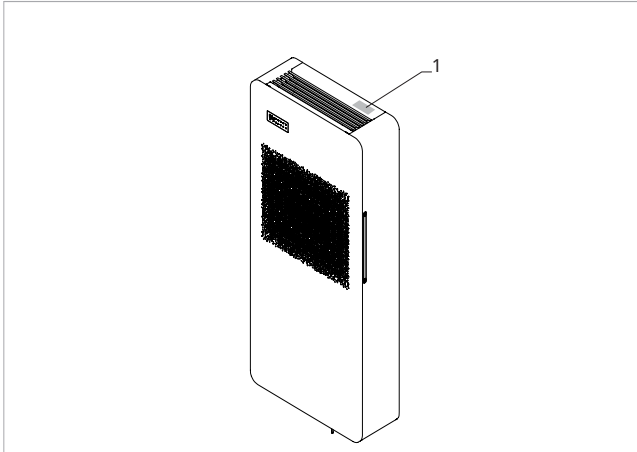

### 3.2 Destination of use

These appliances have been designed for conditioning and/or heating rooms and they must be destined solely for

this purpose, in accordance with their performance characteristics.

⊖ It is forbidden to use the device other than as indicated.

### 3.3 Description of the appliance

The ..2.0 Verticale range of air conditioners without an external unit are designed for indoor installation on a perimeter wall at the top or bottom, in a vertical position.

Inverter technology allows you to optimise the power for maximum comfort. The Dual Power function allows the required temperature to be reached in the shortest possible time (Inverter models only). Control is via a touch panel located on the unit or via a remote control.

**The appliance uses the refrigerant R32.**

All models are heat pump models and are made in different sizes and performance:

**12 HP DC Inverter**

**15 HP DC Inverter**

**15 HP ELEC**

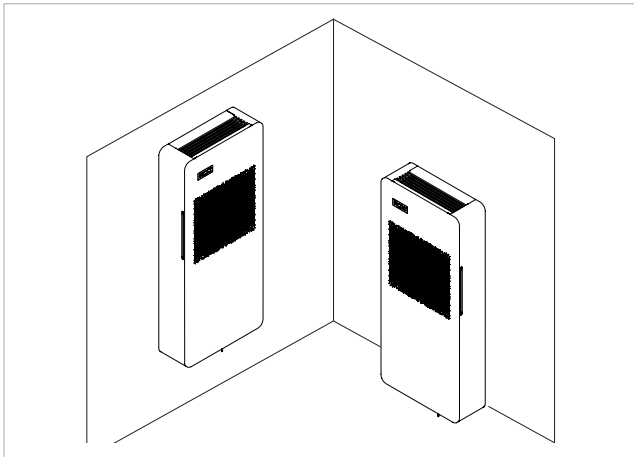

## 3.4 Components

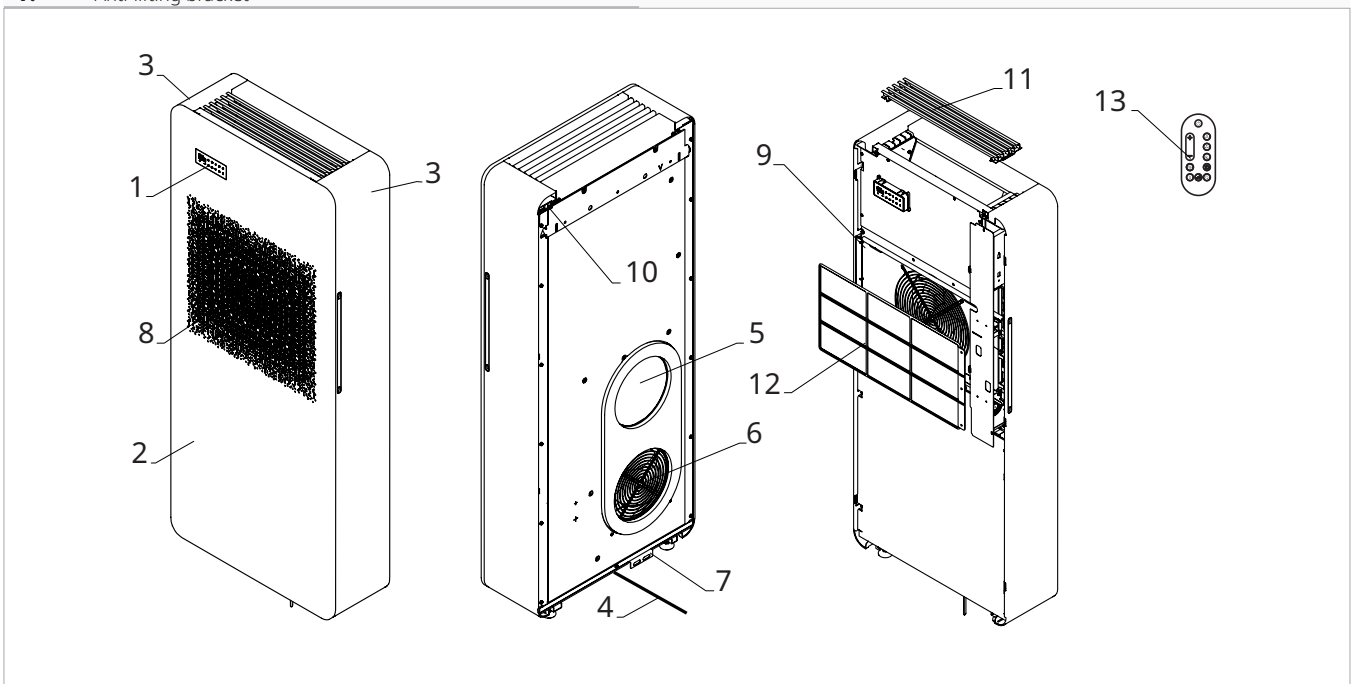

- 1. Control Panel
- 2. Aesthetic front panel
- 3. Aesthetic side panel
- 4. Condensate drain
- 5. External air expulsion
- 6. External air intake
- 7. Anti-lifting bracket

- 8. Internal air intake
- 9. Room air probe
- 10. Power cable outlet
- 11. Internal air expulsion
- 12. Ambient air filter
- 13. Remote control



# General

## 3.5 Compatible accessories

Accessory description		Combinable products	Code
<b>Wall mounted control panels M7 series</b>			
<b>Control panels</b>			
	LED electronic control panel with touch interface, wall-mounted complete with thermostat and room temperature and relative humidity probe. Cable connection. Dimensions (lxhxp): 117x80x5 mm. Colour white	All	<b>EEB749II</b>
	LED electronic control panel with touch interface, wall-mounted complete with thermostat and room temperature and relative humidity probe with integrated Wi-Fi module, new App. Cable connection. Dimensions (lxhxp): 117x80x5 mm. Colour white	All	<b>EFB749II</b>
<b>Built-in boxes</b>			
	Built-in box for masonry	All	<b>N000557A</b>
	Built-in plasterboard box	All	<b>N000558A</b>
<b>Configuration accessories</b>			
<b>Heated condensate drainage pipe</b>			
	Heating element kit for condensate drain pipe.	All	<b>GB1120II</b>
<b>Accessories supplied separately</b>			
<b>Grille and other accessories</b>			
	Rain protection DN 200	All	<b>GB0761II</b>
	Foldable grilles DN 200	All	<b>GB1144II</b>
<b>Condensate nebulizer</b>			
<b>3.0 ZOFF</b>			
	Condensate water nebulization kit, consisting of plastic tray, solenoid pump with support, pump activation/deactivation float, alarm float, metal mesh filter, heated hose, and heated brass nozzle.	All	<b>C060000143 (1)</b>
<b>Aesthetic cover kit</b>			
	Lower aesthetic cover kit, consisting of a painted sheet metal panel, to be used in combination with the nebulizer kit (mandatory combination).	All	<b>GB1155II</b>

1. Kit not compatible with the condensate drain pipe resistance kit.

## 4. INSTALLATION

### 4.1 Preliminary warnings

- ⚠ **For detailed information on the products, refer to chapter "Technical information" p. 51.**
- ⚠ The installation must be carried out by the installer in accordance with national installation codes. There is a risk of water leakage, electric shock or fire if the installation is not performed correctly.
- ⚠ During the installation, it is necessary to observe the precautions mentioned in this manual, and on the labels placed inside the equipment, as well as to adopt any precaution suggested by common sense and by the Safety Regulations in force in the place of installation.
- ⚠ Be sure to use the supplied or specified installation parts. Use of other parts may cause the unit to come loose, leak water, or cause electrical shock, or fire.
- ⚠ The Manufacturer accepts no liability for damage caused to animals or property due to failure to apply the indicated rules which may cause malfunction of appliances.
- ⚠ The air conditioners without an external unit are designed for indoor installation. The only components suitable for outdoor use are the external grilles for air inlet and outlet.

#### 4.1.1 Preliminary warnings for R32

- ⚠ Safety checks must be carried out to ensure that the risk of combustion is minimised before starting work on systems containing flammable refrigerants.
- ⚠ The appliance must be protected against accidental impacts to prevent mechanical damage.
- ⚠ Do not puncture or burn.

### 4.2 Reception

#### 4.2.1 Preliminary warnings

- ⚠ On receipt check for any damage and, if any is found, accept the goods with reservation, and keep photographic evidence of any damage found
- ⚠ The package must be transported in an upright position; otherwise, notify the carrier immediately.
- ⚠ In the event of damage, notify the shipper within 3 days of receipt of any damage by registered mail with return receipt, submitting photographic evidence. Similar information should be sent by fax to the manufacturer (jurisdiction will be at the Court Trento for any dispute).
- ⚠ No notice of damage will be accepted after 3 days from delivery.
- ⚠ Unpack and check the contents of individual components against the packing list.

#### 4.2.2 Package description

The packaging is made of suitable material and carried out by experienced personnel.

All units are checked and tested and are delivered complete and in perfect condition.

The appliance is shipped in standard packaging consisting of a cardboard sleeve and a set of expanded polystyrene protectors.

# Installation

## 4.3 Dimensions and weights with packaging

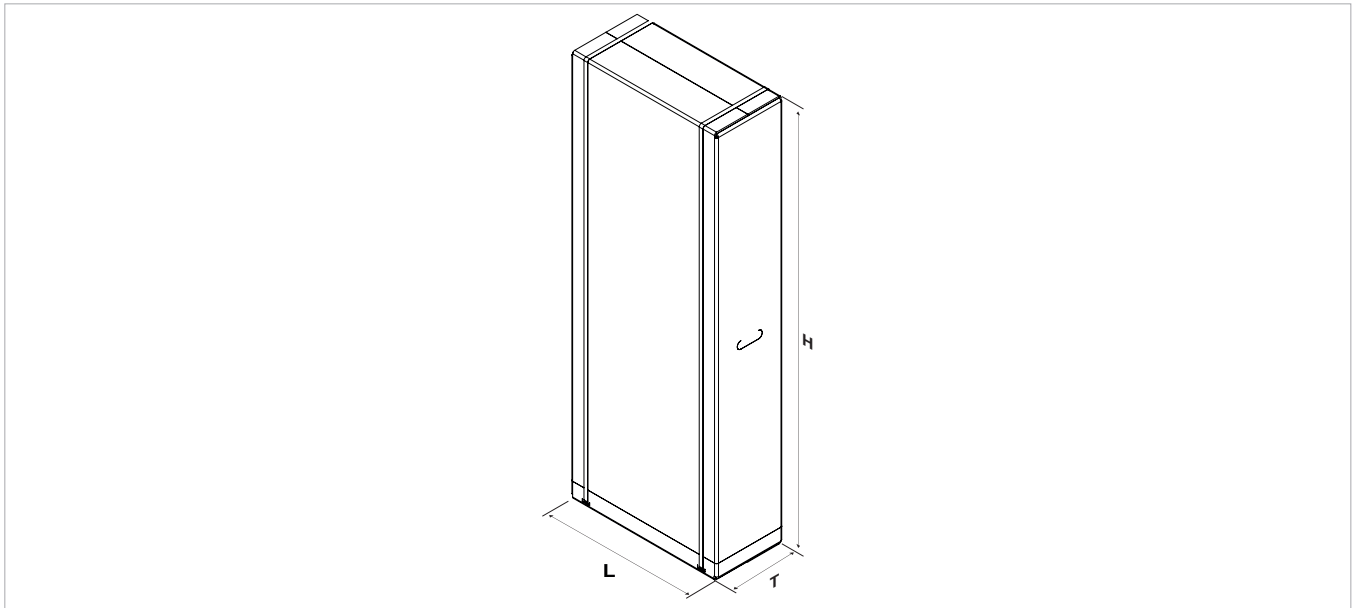

		..2.0 Verticale	
Models	u.m.	12 HP 230 V	15 HP 230 V
<b>Dimensions and weight for shipping</b>			
Width	mm	630	630
Height	mm	1.400	1.400
Total depth	mm	300	300
Weight	kg	65,0	65,0

## 4.4 Handling with packaging

### 4.4.1 Preliminary warnings

- ⚠ The appliance must be handled only by qualified personnel, adequately equipped and with equipment suitable for the weight and dimensions of the appliance.
- ⚠ Stay clear of the area below and around it when the load is lifted off the ground.
- ⚠ Avoid dangerous situations when using a hoist to lift the appliance.
- ⚠ During transportation, the unit must be kept in vertical position.

### 4.4.2 Movement methods

- Boxes can either be carried singularly by hand by two operators or loaded on a forklift truck evenly stacked.
- ⚠ Check the indications on the packaging for the number of packages that may be stacked together.
  - ⚠ In manual operation it is compulsory to always respect the maximum weight per person provided for by the national laws and standards.

## 4.5 Storage

### 4.5.1 Preliminary warnings

- ⚠ Store in accordance with the applicable national regulations.
- ⚠ Store the box in a closed environment protected from atmospheric agents and isolate it from the floor using planks or pallets.

- ⚠ Do not turn the packaging upside down.
- ⚠ Only place the appliance in a vertical position.
- ⚠ Store in a clean and dry place.

## Specific warnings for R32

⚠ Store the unit in such a way as to avoid mechanical damage.

⚠ Check the national/local legislation in force, regarding fire regulations. The refrigerant contributes to the fire load.

## 4.6 Unpacking

### 4.6.1 Preliminary warnings

⚠ Check that no components were damaged during transport.

⚠ Dispose of the packaging components following the applicable waste disposal regulations. Check for disposal arrangements with your municipality.

⚠ Handle with care.

⚠ The equipment must always be handled vertically.

⚠ Check if there is refrigerant inside the package using an electronic leak detector suitable for the system refrigerant. If it is present, the refrigeration circuit is likely damaged. In this case, do not install the appliance and call the Authorised Service Centre.

⊖ The packing material (cardboard, staples, plastic bags, etc.) must not be dispersed or abandoned in the surrounding environment and must be kept out of the reach of children, as it poses a risk of danger.

### Specific warnings for R32

⚠ Check that there are no sources of ignition in continuous operation (open flames, gas appliances, electric stoves, lighted cigarettes, etc.).

⊖ Using leak detectors with halogen lamps is prohibited.

⊖ Smoking in the vicinity of the appliance is prohibited.

⊖ Using a mobile phone near the appliance is prohibited.

### 4.6.2 Remove the package

1. Polystyrene elements

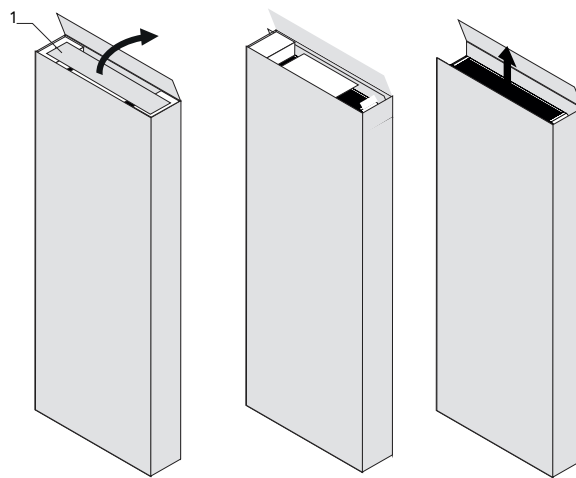

#### Remove the packing:

- ▶ open the cardboard packaging
- ▶ remove the polystyrene elements

- ▶ remove the accompanying components
- ▶ remove the appliance from the box

#### Accompanying material

They are included with the appliance, inside the packaging:

⚠ Check the presence of the individual components. In case of lost, the installation template is available on the website, in the download area.

# Installation

1.	External grills
2.	Screws and dowels kit (6 pcs)
3.	Paper template for holes
4.	Wall mounting bracket
5.	CR2025 3V remote control battery

6.	Wall-mounted roll-up tubes (2 pcs)
7.	Instruction sheet for manual download
8.	Energy efficiency label
9.	QR Code scan label
10.	Remote control

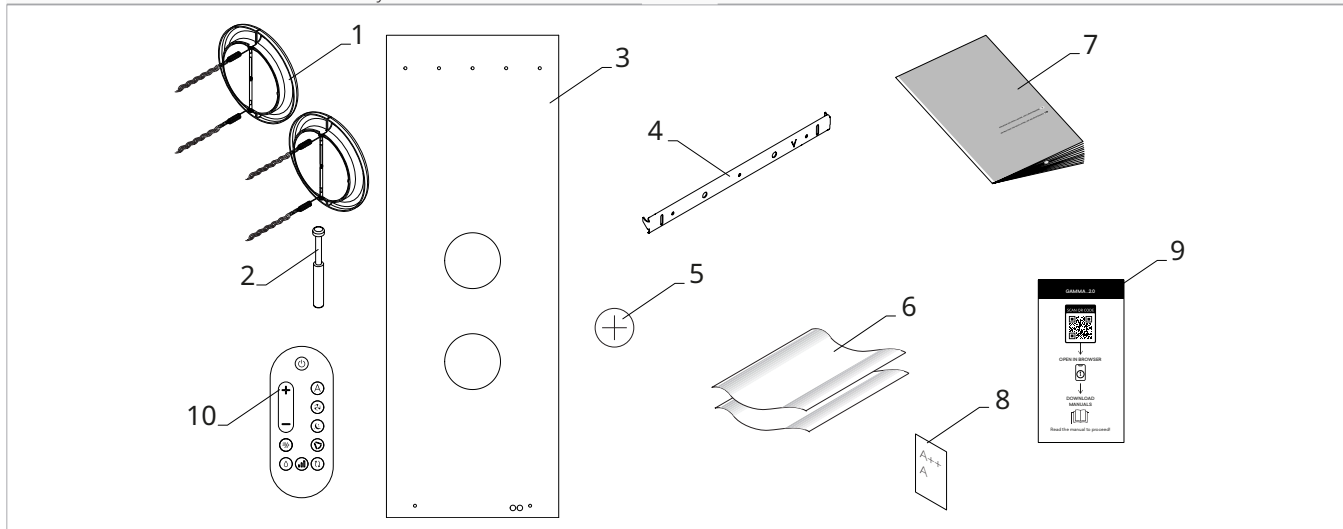

## 4.7 Handling without packaging

### 4.7.1 Preliminary warnings

- ⚠ The appliance must be handled only by qualified personnel, adequately equipped and with equipment suitable for the weight and dimensions of the appliance.
- ⚠ The appliance is unbalanced on the right (compressor side)

### 4.7.2 Movement methods

- ⚠ The unit can be moved manually for short distances. In this case it is necessary to check carefully that the weight of the unit does not exceed the regulations in relation to the number of people used.

## 4.8 Installation site

The location of the appliance must be determined by the plant engineer or a competent person and must take into account both purely technical requirements and any national/local legislation in force. This appliance is designed for vertical indoor installation.

- ⚠ The appliance must be installed against a wall communicating with the outside.
- ⚠ The appliance is stated as having an IPX0 protection rating, therefore it is not suitable for outdoor installation and in rooms with high levels of humidity (swimming pool rooms, etc.).

### 4.8.1 Preliminary warnings

- ⚠ Avoid installing the unit near:
  - obstacles or barriers that cause recirculation of the exhaust air
  - narrow places where the sound level of the appliance can be enhanced by reverberations or resonances
  - environments with the presence of flammable or explosive gases
  - very humid environments (laundries, greenhouses, etc.)
  - environments with aggressive atmospheres

- solar radiation and proximity to heat sources
- ⚠ Avoid placing the unit within 1 metre of radio and video equipment.
- ⚠ Do not install over heat sources.
- ⚠ Make sure that:
  - the installation site of the unit must be chosen with the utmost care to guarantee adequate protection from shocks and consequent damage
  - the supporting structure is able to support the weight of the appliance
  - the support surface does not affect load-bearing elements of the building, pipes, or electrical lines
  - there are no obstacles to the free circulation of air through the holes (plants, leaves...)
  - the appliance must be installed in a position where it can be easily serviced
  - the safety distances between the units and other appliances or structures are scrupulously respected so that the air entering and leaving the fans is free to circulate
- ⚠ If the appliance is installed incorrectly or on an unsuitable surface, it could cause damage to people or property if it detaches from its base.

⚠ The unit should not be installed in a position where the air flow is aimed directly at the people nearby.

- ⚠ Provide the following:
- a nearby drain for the outflow of condensate
  - a compliant power supply nearby
  - fasteners suitable for the support surface used

## Preliminary warnings for R32

⚠ The installation of the unit does not have any special requirements (such as minimum area, room ventilation requirements or sensors) in relation to the use of refrigerants as the quantity used is less than 1.224 kg.

## 4.9 Installation minimum distances

The clearance zones for the installation and maintenance of the appliance are shown in the figure. Established spaces are necessary to avoid barriers to airflow and allow for normal cleaning and maintenance.

⚠ Make sure that there is sufficient space to allow the panels to be removed for routine and supplementary maintenance operations.

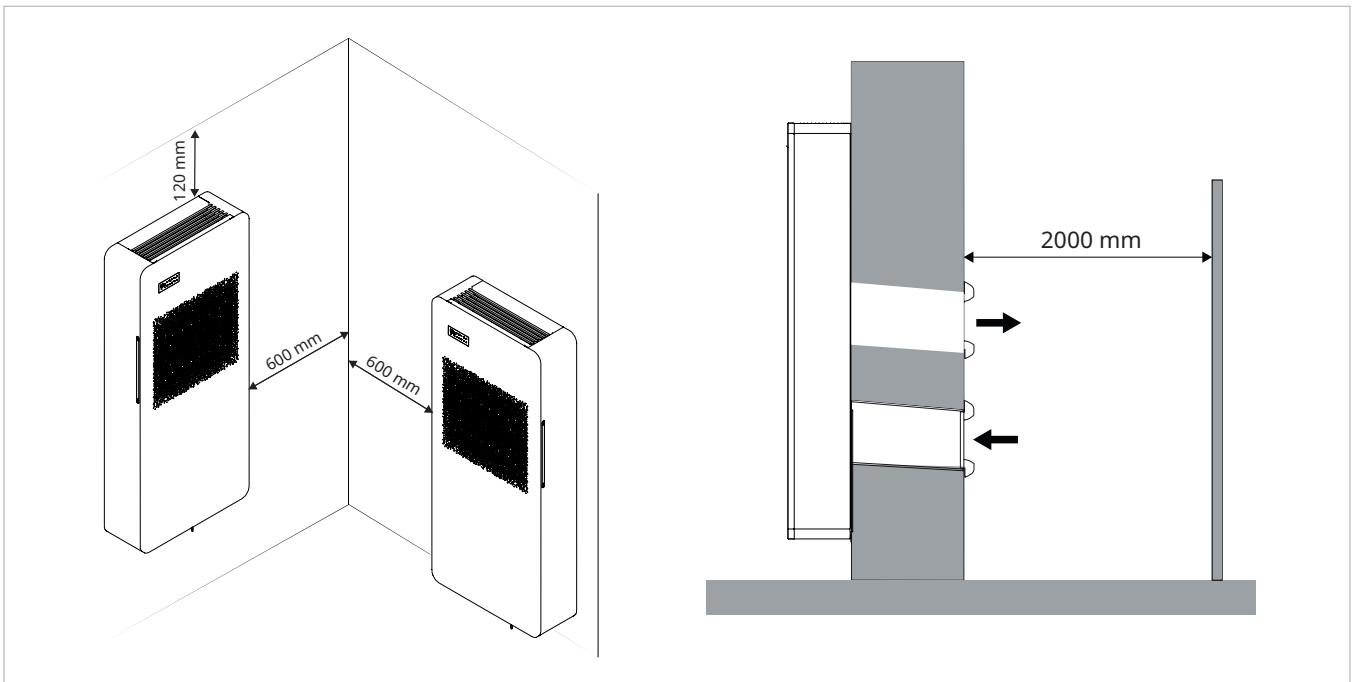

## 4.10 Positioning

The units can be wall-mounted upwards or downwards. The units are supplied with a paper template for marking the holes necessary for installation.

⚠ Hold the template in the correct position with tape.

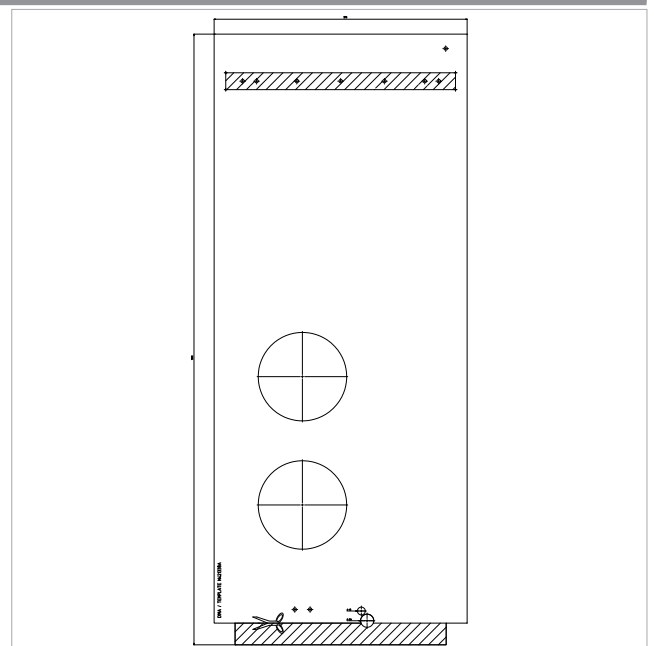

# Installation

## 4.10.1 Preliminary warnings

⚠ The wall mounting bracket supplied as an accessory is required to position the unit on the wall.

- ⚠ Make sure that:
- the support surface is capable of supporting the weight of the appliance
  - the support surface does not affect load-bearing elements of the building, pipes, or electrical lines
  - the functionality of load-bearing elements is not compromised

## 4.10.2 Installation arrangement

### Wall drilling for ducts

<b>A</b>	Side of the wall towards the interior
<b>B</b>	Side of the wall towards the exterior
<b>1.</b>	Perimeter wall
<b>2.</b>	Unit
<b>3.</b>	Return and expulsion grilles
<b>4.</b>	Outside air ducts

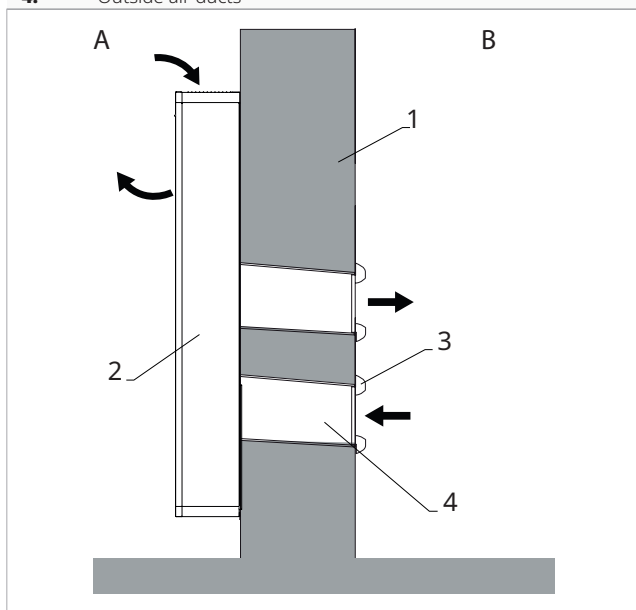

- ▶ position the paper template
- ▶ mark the positions of the holes for the ducts
- ▶ use a drill
- ▶ drill a pilot hole
- ▶ use a core drill
- ▶ drill the through hole into the wall
- ▶ keep a downward inclination toward the external side

- ⚠ The maximum length of the holes is 1 meter.
- ⚠ The two holes must have a diameter of 202 mm, as indicated on the paper template.
- ⊖ Curves are prohibited.
- ⚠ To prevent the creation of large quantities of dust and debris in the room it is recommended to couple the core drill to a vacuum system.
- ⚠ Proceed with caution in the vicinity of the outer wall in order to avoid the breakage of plaster around the hole.
- ⚠ Take precautions so that the drilled material does not fall on persons and objects below.

### Positioning the ducts

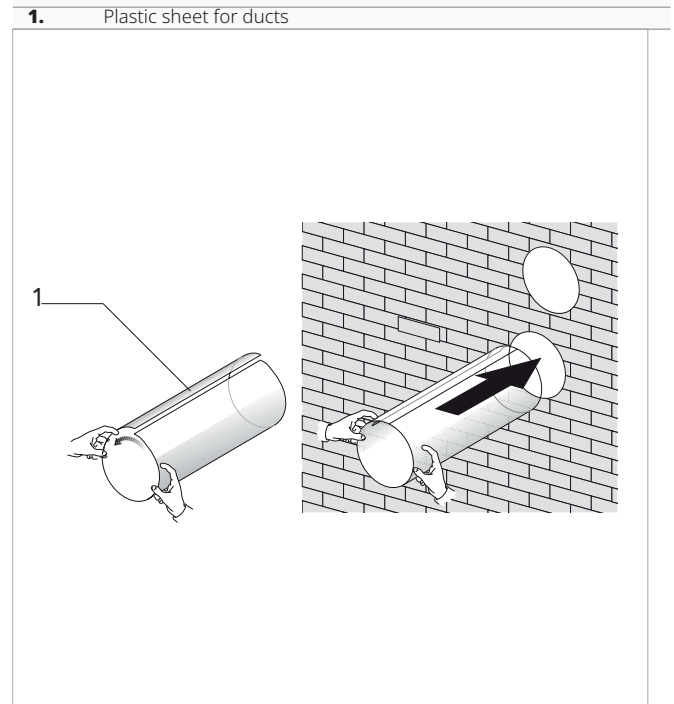

- ▶ measure the depth of the holes drilled in the wall
- ▶ subtract 5 mm from the measurement
- ▶ cut the plastic sheets supplied to size
- ▶ roll the plastic sheet
- ▶ insert the rolled sheet into the hole
- ▶ position so that the edges of the sheet are 2 mm inside both ends of the hole

### Positioning outside air dampers

Before proceeding with the installation of the external air dampers, it is necessary to discern the one to be positioned on the air intake from the one intended for the expulsion. The dampers are identified with the labels:

- IN:** air intake damper
- OUT:** air delivery damper

⚠ Use only the dampers supplied with the unit.

1. Paper template
2. Air intake damper (IN)
3. Air expulsion damper (OUT)

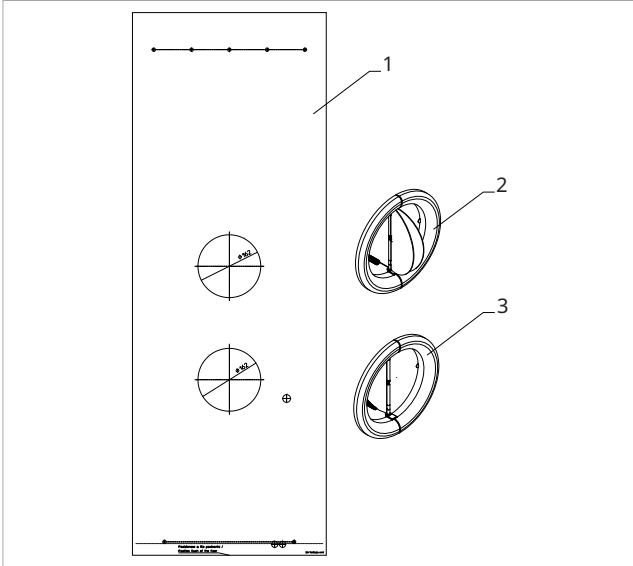

1. Chain
2. Counterflange
3. Spring
4. External air damper

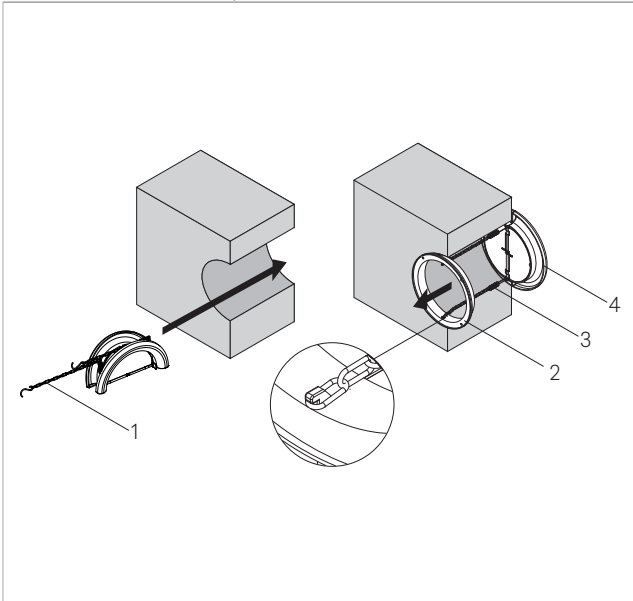

- ▶ fold the damper
- ▶ insert it in the duct until it comes out on the other side of the wall
- ▶ hold the chains with the other hand so that the damper does not fall
- ▶ open the damper outside of the hole
- ▶ rotate the damper so that the flaps are in vertical position
- ▶ insert the counterflange in the hole toward the interior of the room
- ▶ rotate it so that the hooks are in vertical position
- ▶ pull the chains so that the springs are in tension
- ▶ hook the chains to the counterflange
- ▶ cut off the excess of chain

## Fixing the bracket

The devices are provided with metallic support for mounting on the wall.

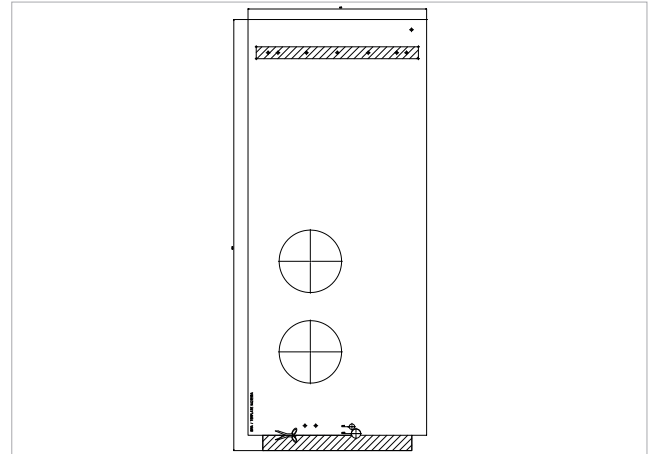

- ▶ use the paper template
- ▶ mark the positions of the fixing holes
- ▶ use a drill
- ▶ drill holes at the marked positions
- ▶ fix the metallic support with the screws and the wall plugs

⚠ The dowels supplied require holes with a diameter of 8 mm to be drilled.

⚠ Place the metallic support on a level surface that is capable of supporting its weight.

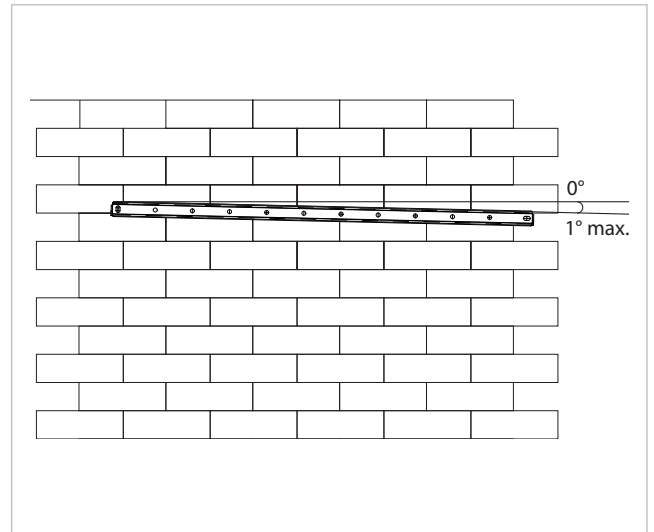

⚠ Check that the installation is horizontal using a water level.

⚠ A maximum inclination of 1° towards the right side of the appliance is allowed to facilitate the drainage of condensate.

# Installation

## Positioning the device

⚠ Check that the fixing bracket is securely attached to the wall.

⚠ Check that electrical connection and condensate drainage arrangements have been made, if necessary.

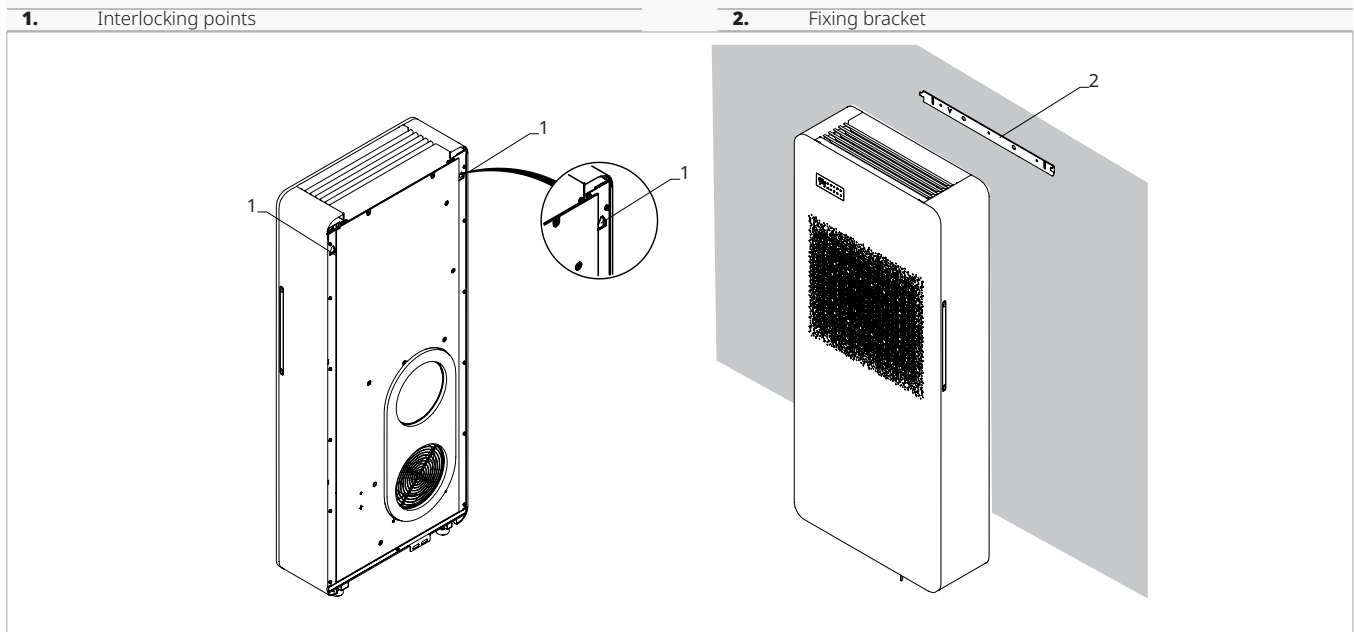

- ▶ fasten the unit to the upper part of the metallic support
- ▶ verify the correct hooking to the interlocking points

⚠ To facilitate connections, a spacer can be used to keep the bottom of the unit away from the wall.

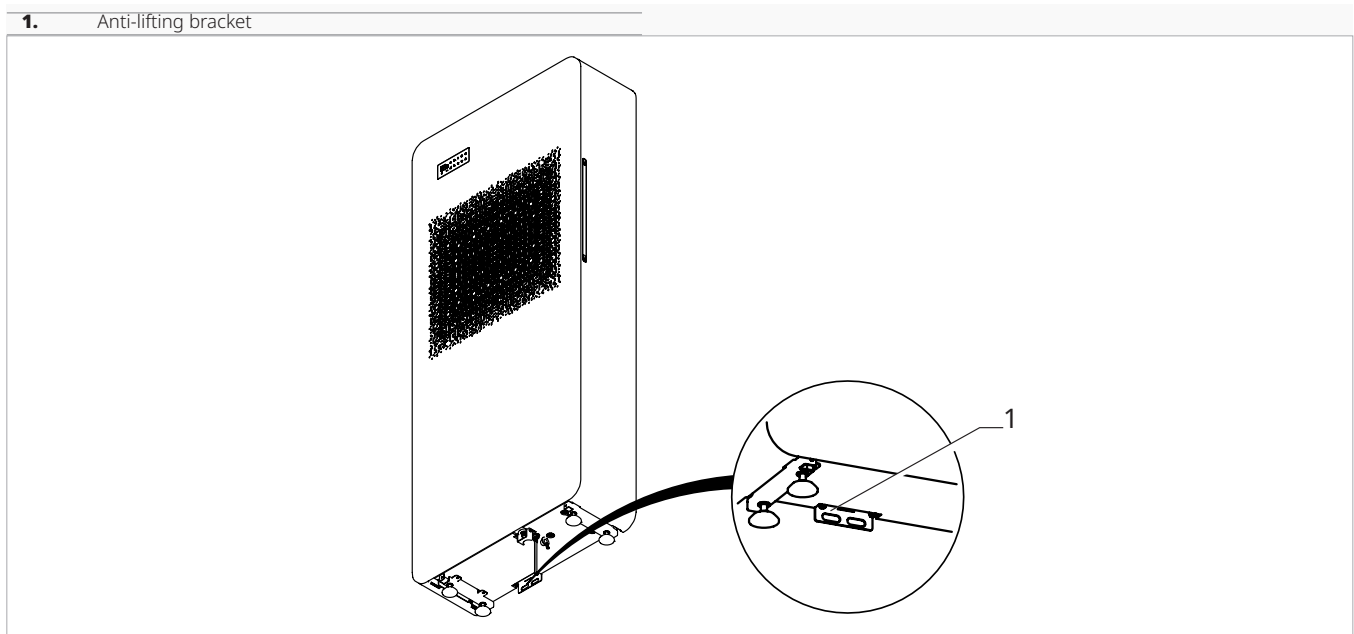

To increase the safety of the installation, it is possible to anchor the unit to the wall by means of a special bracket on the bottom of the unit.

⚠ The position of the holes can be taken from the installation template.

## 4.11 Condensation drain preparation

This appliance is complete with a tray for collecting the condensation produced during heating, cooling and dehumidification operation. The size and positioning of the drainage tube are shown below.

In heating operation, condensation should be conveyed to a appropriate place by providing a condensate drain.

In cooling or dehumidification operation, the unit has a system for self-disposal of condensation.

# Installation

In these modes of operation, an external condensate drain does not need to be provided.

In cooling or dehumidification function, in extreme operating condition (high temperature and high humidity) the unit may not be able to automatically dispose of the produced condensate, in this case the display will show OF. Refer to the "Maximum condensate collection level warning" p. 49 section for more details.

## 4.11.1 Preliminary warnings

- ⚠ Condensate drainage is mandatory when using the appliance in heating mode.
- ⚠ If the line flows into a container (e.g. a tank), do not close the container hermetically and avoid immersing the draining pipe into the water.
- ⚠ The hole for the condensation pipe must always slope towards the outside.
- ⚠ The exact position in which to place the pipe mouth is indicated on the template.
- ⚠ Check that the expelled water does not cause any damage or problems to people or objects. During winter, this water may create sheets of ice outside.
- ⚠ When connecting the condensation drain, be careful not to squeeze the rubber duct.
- ⚠ It is possible to empty the collection tray using the safety drain at the base of the appliance if necessary.
- ⚠ If you do not want to prepare an external drainage pipe in "cold only" mode, it is advisable to close the condensate drain with a plug.

## 4.11.2 Positioning

1. Safety drain for emptying tray
2. Condensate drain pipe

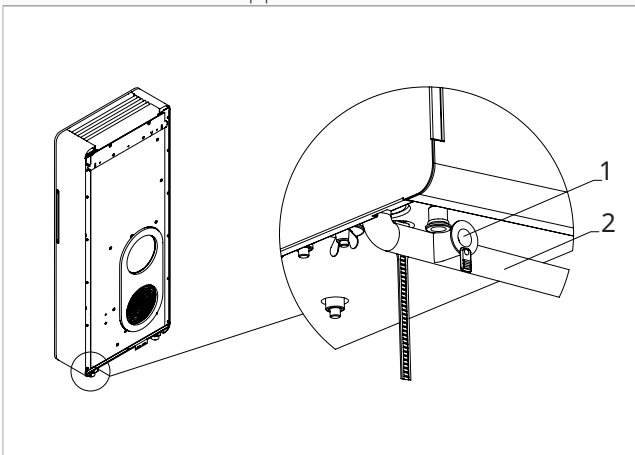

The device is factory supplied with a stub pipe connected to the condensation drain connection. If it is not enough:

- ▶ remove the nozzle from the discharge connection
  - ▶ connect a drainage pipe of greater length not supplied
  - ▶ keep a minimum slope of 3% towards the drain location
  - ▶ insulate fitting points
- ⚠ Use plastic drainage pipes.

- ⚠ Avoid pipes made of metallic material.
- ⚠ Drainage pipes can be made of rigid or flexible material with a minimum internal diameter of 16 mm.
- ⚠ Make sure all joints are sealed to prevent leakage of water.
- ⚠ Condensate drainage pipes must be insulated for both indoor and outdoor sections of the house to avoid condensation on the surface and/or freezing problems.
- ⚠ It is possible to empty the collection tray using the safety drain at the base of the appliance if necessary.

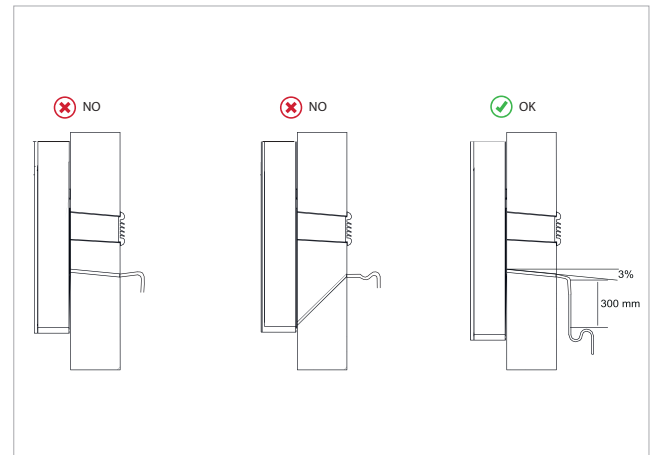

- ⚠ Drainage of condensation occurs by gravity.
  - ⚠ The drain line must have a minimum slope of 3%.
- If using a tank for collecting the condensation:**

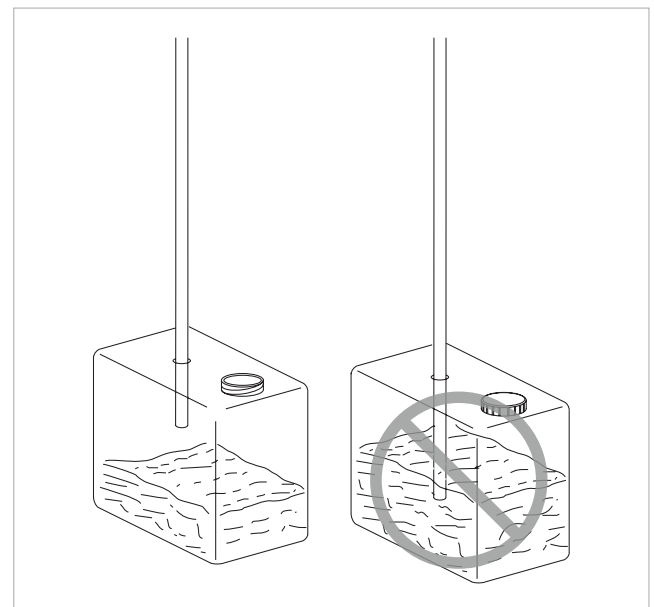

- ⚠ Avoid the hermetic closure of the container.
  - ⚠ Prevent the end of the drainage tube from falling below the water level.
- If draining into the sewage system:**
- ⚠ The discharge system must feature a suitable syphon in order to prevent air from entering the vacuum system. The syphon also prevents odours and insects from entering the system.

# Installation

⚠ The trap must feature a plug in its lower part or must otherwise allow for quick disassembly for cleaning purposes.

## If using an open drain:

⚠ If the condensation is not collected, it will be deposited on the support surface. The water could freeze if the outdoor temperatures are below zero, thus creating a hazard. In this case, appropriate barriers should be installed in order to prevent people from approaching the area.

### 4.11.3 Condensate drain pipe insulation

In case of condensate drain pipe use, the pipe must be coated with anti-condensation insulation for the internal part of the building and the wall (internal diameter 10 mm).

⚠ The insulation must be fitted until the condensate drain pipe is plugged into the connection provided on the unit.

- |    |                   |
|----|-------------------|
| 1. | Unit              |
| 2. | Ventilation holes |
| 3. | Wall section      |

- |    |                   |
|----|-------------------|
| 4. | Emergency drain   |
| 5. | Insulator         |
| 6. | Liquid drain pipe |

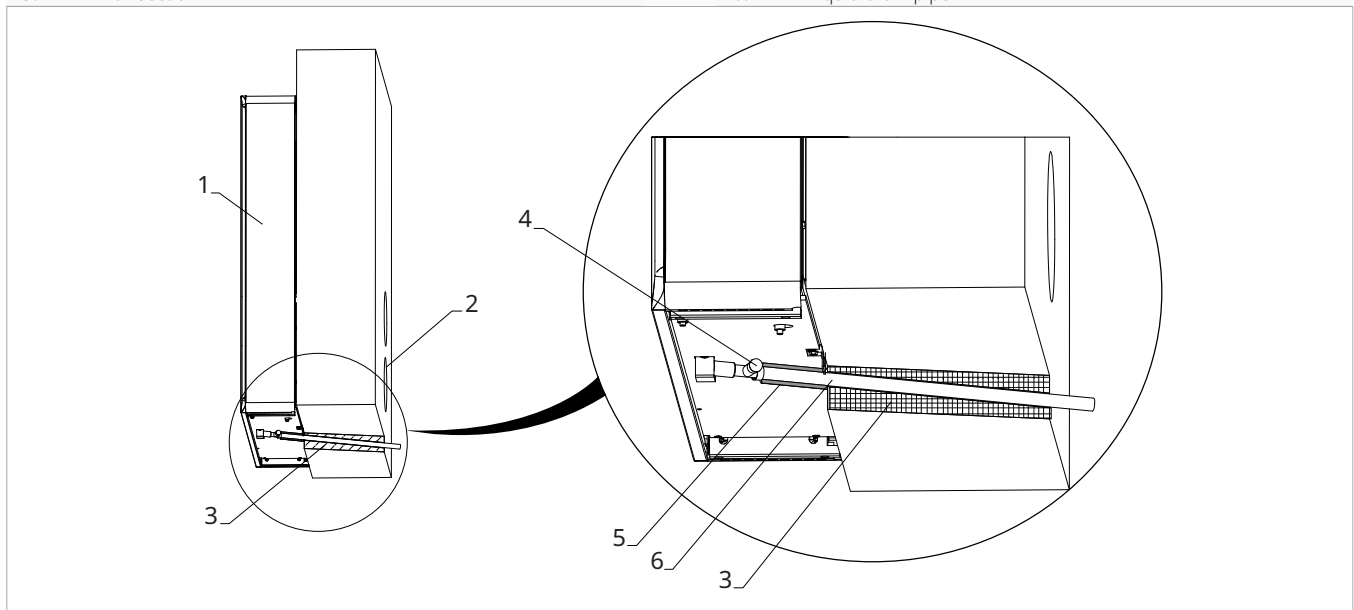

## 4.12 Electric connections

### 4.12.1 Preliminary warnings

- ⚠ Before carrying out any work, make sure that the power supply is switched off.
- ⚠ The control panel is fixed on the front panel and is connected to the device by a connector.
- ⚠ References:
  - refer to the wiring diagrams in this manual for the electrical connections, especially the part concerning the power supply terminal block
- ⚠ Before connecting the conditioner check that:
  - the power supply voltage and frequency values comply with the data plate of the appliance.
  - the line has a suitable earth connection and that it is sized for the maximum absorption of the conditioner (minimum cable section equal to 1,5 mm<sup>2</sup> and 2,5 mm<sup>2</sup> for ELEC versions)
  - the socket used is compatible with the plug provided
- ⚠ It is required:
  - provide a suitable grounding connection

- provide an all-pole switch with a contact opening distance of 3 mm or more that allows complete disconnection under overvoltage category III conditions
- Install a residual-current device. Failure to install this device may result in electric shock

- ⚠ Use a dedicated power supply circuit. Never use a power supply to which another appliance is also connected because of the risk of overheating, electric shock or fire.
- ⚠ For the electrical connection, use a cable that is long enough to cover the entire distance without any connection. Do not use extension cables. Do not apply other loads on the power supply.
- ⚠ After connecting the interconnection and power cables, make sure that the cables are arranged so as not to exert excessive forces on the covers on the cables. Incomplete connections of the covers may result in overheating of the terminals, electric shock or fire.
- ⚠ Any replacement of the power cable must be carried out by authorised personnel and in accordance with the applicable national codes.

# Installation

- ⚠ The Manufacturer is not liable for any damage caused by the lack of earthing or failure to comply with the specifications in the respective diagrams.
- ⚠ Please check that the power supply is provided with suitable protections against overloads and/or short-circuits (using a 10 Amp Time delay fuse or other equivalent devices is recommended).
- ⚠ To prevent any risk of electrocution, always disconnect the main circuit breaker before making electric connections or performing any maintenance on the units.
- ⚠ Access to the electrical panel is only necessary when replacing the wired cable or when using the presence contact.
- ⊖ It is forbidden the use of gas and water pipes for grounding the appliance.

## Preliminary warnings for R32

- ⚠ R32 refrigerant gas is mildly flammable and odourless.

- ⚠ Do not place flammable objects (spray cans) within 1 metre of the air outlet.
- ⚠ All precautions concerning the treatment of the refrigerant must be observed following the regulations in force.
- ⚠ Avoid proximity to sources of ignition in continuous operation (open flames, gas appliances, electric stoves, lighted cigarettes, etc.).
- ⊖ Smoking in the vicinity of the appliance is prohibited.
- ⊖ Using a mobile phone near the appliance is prohibited.
- ⚠ Perform the following checks:
  - carry out safety checks to ensure that the risk of combustion is minimised
  - avoid working in confined spaces
  - delimit the area around the workspace
  - ensure safe working conditions around the area by controlling flammable material

## 4.12.2 Access to the electrical panel

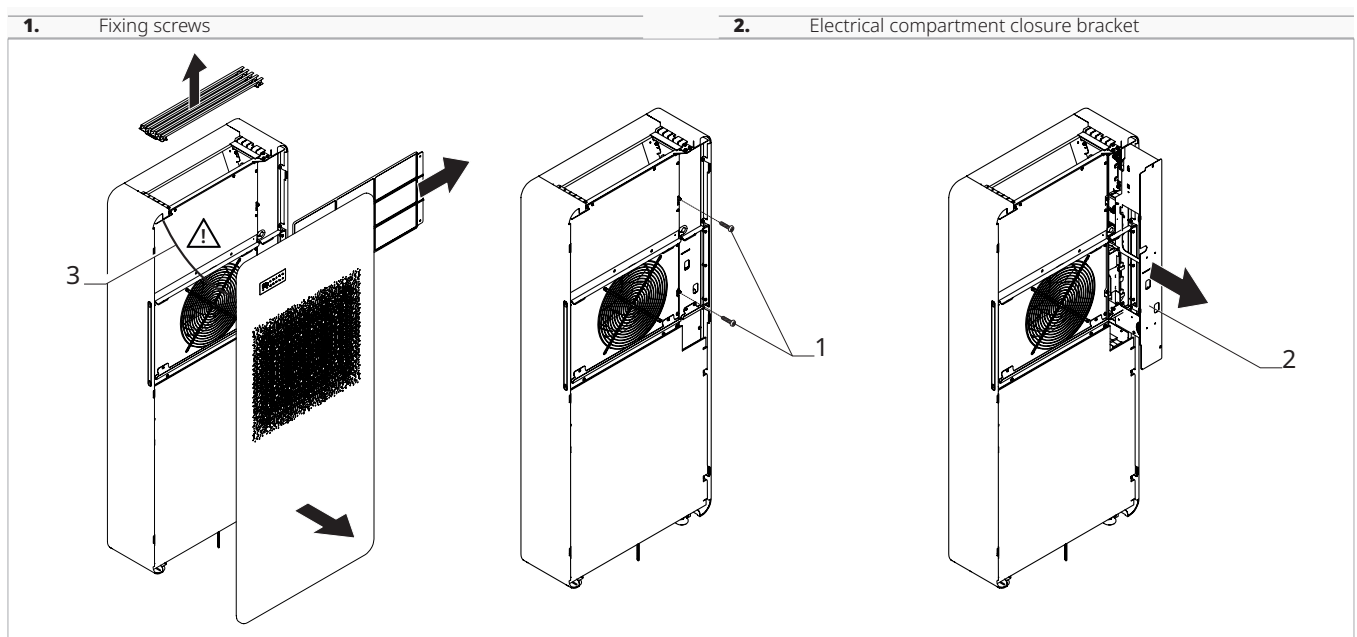

- ⚠ Access to the electrical panel is only permitted to qualified personnel.
- ⚠ Before carrying out any work, please ensure the power supply is disconnected.
- ⚠ The control panel is fixed on the front panel and is connected to the device by a connector.
- ⚠ Disconnect the connector when opening the front panel.

### To access:

- ▶ remove the front panel, if fitted
- ▶ follow the instructions in chapter "Disassembly and assembly of cosmetic panels and grilles" *p. 25*.

### To access the connections:

- ▶ unscrew the screws securing the electrical compartment cover bracket
- ▶ remove the electrical compartment locking bracket

## 4.12.3 Connection

The appliance leaves the factory fully wired and equipped with a cable with Y-type plug for connection to the power supply. To power the unit simply insert the plug into a suitable socket protected by a circuit breaker.

- ⚠ In the event of damage to the power cable, contact the Technical Service Centre or qualified personnel for replacement.
- ⊖ It is forbidden to replace damaged cables yourself.

# Installation

1. Circuit breaker
2. F-type socket
3. Plug (supplied)

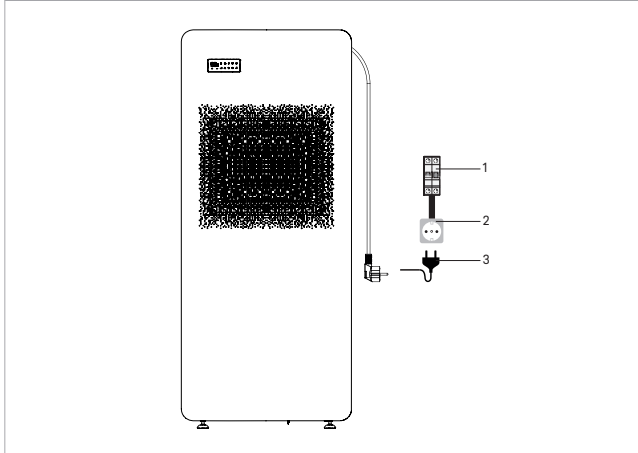

## 4.12.4 CP occupancy contact input connection

When the CP contact opens (very low voltage, connected to a volt-free contact) the appliance is put in stand-by and CP appears on the display.

Through this contact it is possible to connect an external device that inhibits operation of the unit such as: window

opening contact, remote on/off, infrared presence sensor, activation badge etc.

**⚠** We recommend using a double insulated cable.

**⚠** For the ELEC versions with resistor, disconnecting voltage from the device abruptly is prohibited in order to prevent internal overheating! Use the CP contact that places the device in standby and guarantees correct post-ventilation.

**CP** Presence contact (normally jumpered)

**B A** Serial connection

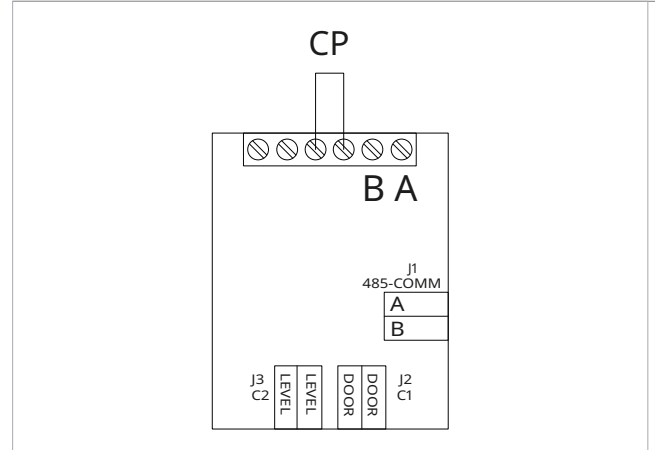

## 4.13 Operations after installation

Before leaving the site, the packaging should be gathered up and all traces of dirt that have deposited on the unit during assembly should be eliminated with a damp cloth.

Once all the checks and controls on the correct operation of the appliance have been completed, the installer must explain the following to the user:

- the basic characteristics of the appliance
- the instructions for use
- the routine maintenance
- how to clean the filter

## 4.14 Disassembly and assembly of cosmetic panels and grilles

⚠ Before carrying out any work, please ensure the power supply is disconnected.

⚠ The control panel is fixed on the front panel and is connected to the device by a connector.

⚠ Disconnect the connector when opening the front panel.

- |    |               |
|----|---------------|
| 1. | Upper grille  |
| 2. | Fixing screws |
| 3. | Crossbar      |

- |    |                       |
|----|-----------------------|
| 4. | Aesthetic front panel |
| 5. | Filter                |
| 6. | Connectors            |

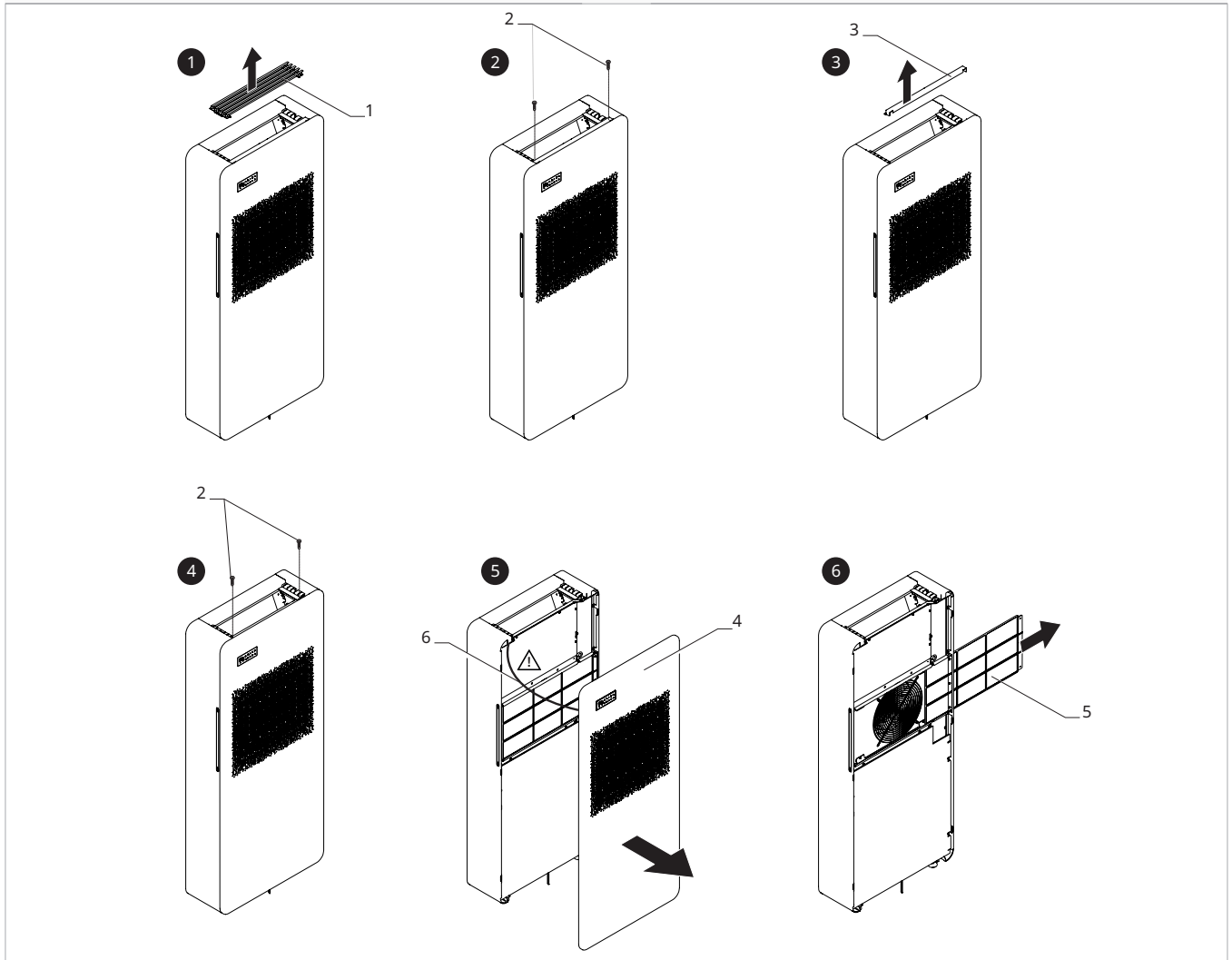

### To remove:

- ▶ remove the upper grille
- ▶ Unscrew the screws securing the crossbar.
- ▶ remove the crossbar
- ▶ unscrew the front panel fixing screws
- ▶ lift the front panel
- ▶ disconnect the connector of the on-board control
- ▶ remove the aesthetic front panel
- ▶ slide the filter sideways out of its housing

⚠ To install the front panel and grille, proceed in reverse order.

## 5. TOUCHPAD AND REMOTE CONTROL

### 5.1 Interface

#### 5.1.1 Description

The touchpad control is supplied as standard on board the unit, does not require any connections and enables:

- show the operating status
- show any alarms
- select the various functions

#### 5.1.2 Touchpad

Keys and functions related.

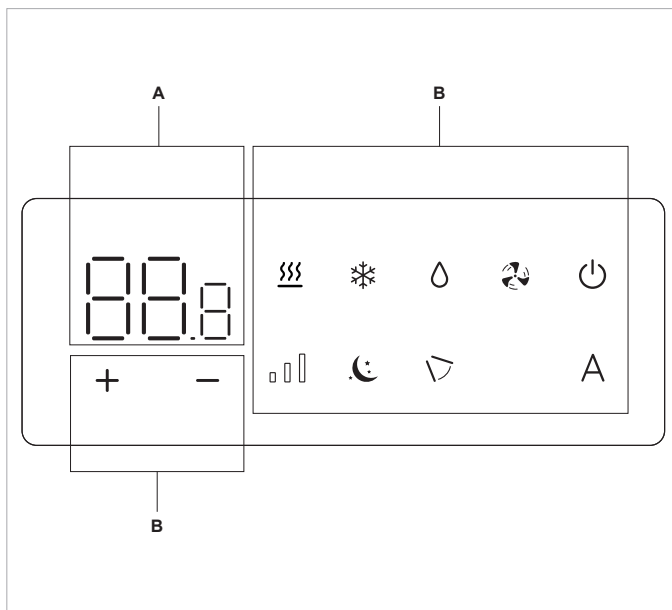

<b>A</b>	Display area
<b>B</b>	Keys area
	Setpoint
	Up key
	Down key
	Allows you to select the Heating mode of operation
	Allows you to select the Cooling mode of operation
	Allows you to activate the Dehumidification function
	Allows you to activate the Ventilation function
	This can be used to switch the unit on or off
	Allows you to control ventilation speed
	Enables the Night function
	Enables the mobile baffle control function (not used)
	Enables the Automatic function

### 5.2 Basic menu

#### To access the basic menu

- ▶ press for 10 seconds  
Appears .

#### To move within the menu or change values

- ▶ use

#### To select a menu item and to confirm the changes made

- ▶ press   
The menu item is selected and the settings are accessed.  
Changes are confirmed when the symbol appears.

#### To exit menu items without saving

- ▶ press   
You exit the selected menu item.

#### To exit the basic menu

- ▶ press once   
Appears .

- ▶ press again  
You exit the basic menu.

After a period of 30 seconds from the last action, the display turns off.

#### 5.2.1 Menu items

**Ub:** Buzzer volume

**uP:** Wi-Fi pairing

**ur:** Wi-Fi reset

**oH:** Temperature offset in Heating

**oC:** Temperature offset in Cooling

**CF:** Scale

**Ht:** Resistance type configuration (only valid for models..2.0 Vertical ELEC)

## 5.2.2 Buzzer volume









### To change the volume

- ▶ select  the volume setting range is from 0 (min) to 3 (max).

⚠ The volume changes after change is confirmed.

## 5.2.3 Activate Wi-Fi









### To activate Wi-Fi

- ▶ select 
- ▶ press  to change settings
- ▶ use the   icons in sequence  
Appears  
- ▶ press 
- ▶  appears to enable Wi-Fi pairing.
- ▶ press  to confirm

⚠ The device remains visible on the App for the first 15 minutes after the device is switched on.

## 5.2.4 Wi-Fi reset

### To reset the Wi-Fi credentials and return the device to its original configuration



- ▶ select 
- ▶ press  to change settings
- ▶ use the   icons in sequence  
Appears  
- ▶ press 
- ▶  appears to reset Wi-Fi credentials.
- ▶ press  to confirm  
Credentials have been reset.

## 5.3 Advanced Menu



Through the control panel, it is possible to access the advanced menu.

⚠ **To access the advanced menu, it is first necessary to access the basic menu. See section "Basic menu" p. 26.**



### To access the advanced menu

- ▶ from the basic menu press   at the same time for about 5 seconds  
Appears   
The advanced menu is accessed.

### To move within the menu or change values

- ▶ use  

### To select a menu item and to confirm the changes made

- ▶ press   
The menu item is selected and the settings are accessed.  
Changes are confirmed when the symbol  appears.

## 5.2.5 Temperature offset in Heating

### To set the temperature offset in Heating

- ▶ select   
The temperature offset setting range in Heating is from -9 °C (minimum) to 9 °C (maximum).

⚠ The range for °F is smaller, equivalent to -5 °C/5 °C.

## 5.2.6 Temperature offset in Cooling

### To set the temperature offset in Cooling

- ▶ select   
The temperature offset setting range in Cooling is from -9 °C (minimum) to 9 °C (maximum).

⚠ The range for °F is smaller, equivalent to -5 °C/5 °C.

## 5.2.7 Heating element type configuration

⚠ **This setting is visible in the basic menu only for models..2.0 Vertical ELEC.**

### To configure the heating element type

- ▶ select 
- ▶ select NO to disable the heating element
- ▶ select r1 to configure the heating element to 1 kW  
By default the device is set to r1.

## 5.2.8 Scale



### To change the temperature unit of measure

- ▶ select 
- ▶ select °C or °F  
By default the temperature unit of measure is °C.

### To exit menu items without saving

- ▶ press   
You exit the selected menu item.

### To exit the settings menu

- ▶ press   
Appears   
You return to the basic menu.

⚠ After a period of 30 seconds from the last action, the display turns off.

## 5.3.1 Menu items

**HC:** Heating only or Cooling only configuration

**ho:** Hotel Mode

**in:** Installation location (Not usable)

**Ad:** Modbus address

**rF:** Remote function

# Controls

**co:** Connectivity expansion module

**Hr:** ERV module activation (Not usable)

**Hn:** ERV module operating mode (Not usable)

**Sn:** Nebulization kit activation

**At:** Summer condensate drain activation

**HL:** Configuration minimum temperature limit in heating.

**Hh:** Configuration of maximum temperature limit in heating mode.

**CL:** Configuration minimum temperature limit in cooling.

**Ch:** Configuration maximum temperature limit in cooling.

**HE:** Heating element operation mode configuration (only for models with electric heating element)

## 5.3.2 Heating only or Cooling only configuration

⚠ It is possible to disable the Heating or Cooling function by setting the unit in Heating only or Cooling only mode.

### To set the Heating only or Cooling only mode

- ▶ select  $\overline{H\overline{C}}$
  - ▶ select hc to set the Heating and Cooling mode
  - ▶ select ho to set the Heating only mode
  - ▶ select co to set the Cooling only mode
- By default, the unit is set to Hc.*

## 5.3.3 Hotel Mode

### To set the Hotel mode

- ▶ select  $\overline{H\overline{O}}$
  - ▶ select YS to turn on Hotel mode
  - ▶ select NO to turn off the Hotel mode
- By default the device is set to NO.*

Activating the Hotel mode:

- the Dehumidification Only and Automatic functions are deactivated
- only the Ventilation Only, Heating and Cooling functions remain active
- the temperature setting range is reduced, in Cooling you can set from 22 °C to 28 °C, in Heating you can set from 16 °C to 24 °C

## 5.3.4 Modbus address

### To set the Modbus address

- ▶ select  $\overline{A\overline{d}}$
  - ▶ act on  $\overline{+} \overline{=}$
- the setting range is from 1 (min) to 99 (max).  
By default the device is set to 1.*

## 5.3.5 Remote function

### To set the Remote function

- ▶ select  $\overline{r\overline{F}}$
  - ▶ select no to disable the Remote function
  - ▶ select YS to enable Remote function
- By default, the device is set to no.*

⚠ Set the remote mode to make the touchpad view only.

## 5.3.6 Connectivity expansion module

### To enable or disable the connectivity expansion module

- ▶ select  $\overline{C\overline{E}}$
  - ▶ select YS to activate the connectivity expansion module
  - ▶ select no to disable the connectivity expansion module
- By default, the appliance is set to YS.*

⚠ In case of pairing with a wall control of the M7 series, it is mandatory to disable the connectivity expansion module.

## 5.3.7 Heating element operation mode configuration

⚠ Use only for models with heating element.

### To configure the operation mode of the heating element

- ▶ select  $\overline{H\overline{E}}$
  - ▶ select rE for combined heat pump and heating element operation
  - ▶ select rH for heating element-only operation (Heating only)
  - ▶ select rt for alternating operation
- with external temperature > -10 °C, combined operation of heat pump and resistance is activated
  - with external temperature < -10 °C, operation with only resistance is activated
- By default, the unit equipped with electric resistance is set to rE.*

## 5.3.8 Nebulization kit activation

⚠ Function valid only for models with nebulization kit installed.

### To enable the nebulization kit

- ▶ select  $\overline{S\overline{N}}$
  - ▶ select NO to disable the nebulization kit
  - ▶ select YS to enable the nebulization kit
- By default the device is set to NO.*

## 5.3.9 Summer condensate drain activation



### To enable the summer condensate drain function

- ▶ select  $\overline{A\overline{t}}$
  - ▶ select NO to disable
  - ▶ select YS to enable
- By default the device is set to NO.*

## 5.3.10 Set the minimum temperature limit in heating

⚠ The function can only be activated with  active.

To set the minimum temperature limit in heating

- ▶ select 
- ▶ act on 



The setting range is from a minimum of 16 to Hh-1.  
By default it is set to 16 °C.

⚠ Between HL and Hh the set value varies by 1 °C.

## 5.3.11 Set the maximum temperature limit in heating

⚠ The function can only be activated with  active.

To set the maximum temperature limit in heating

- ▶ select 
- ▶ act on 



The setting range is from a minimum of HL+1 to 31.  
By default it is set to 24 °C.

⚠ Between HL and Hh the set value varies by 1 °C.

## 5.3.12 Set the minimum temperature limit in cooling

⚠ The function can only be activated with  active.

To set the minimum temperature limit in cooling

- ▶ select 
- ▶ act on 



The setting range is from a minimum of 16 to Ch-1.  
By default it is set to 22 °C.

⚠ Between CL and Ch the set value varies by 1 °C.

## 5.3.13 Set the maximum temperature limit in cooling

⚠ The function can only be activated with  active.

To set the maximum temperature limit in cooling

- ▶ select 
- ▶ act on 

The setting range is from a minimum of CL+1 to 31.  
By default it is set to 28 °C.

⚠ Between CL and Ch the set value varies by 1 °C.

## 5.4 Visualization of alarms on display

⚠ In the event of an alarm, the device still maintains active functions.

⚠ A flashing  symbol and alarm code are displayed on the touchpad to indicate alarms.

Code	Alarm description
Er01	Room temperature probe error (RT)
Er02	Error of the temperature sensor of the internal heat exchanger (IPT)
Er03	Error outdoor air temperature probe (OT)
Er04	Error of the external heat exchanger temperature probe (OPT)
Er05	Malfunctioning of the internal fan
Er06	Malfunction of the external fan
Er07	Driver communication error
Er08	Compressor discharge temperature probe (TD) error
Er09	Communication error with remote thermostat M7
OF	Maximum level float intervention in the condensate drip tray (ALARM)
CP	Open (CP) contact
Er12	Driver error - compressor failure
CE	Communication error between main circuit board and display
Er16	4-way valve management error or alarm for insufficient refrigerant charge
Er17	Driver parameter error or compressor incompatibility
Er19	Heating element safety temperature probe error (LEVEL)
Er20	Error of the second temperature probe of the external heat exchanger (GT)
Er22	Wrong power supply

Code	Alarm description
BL	Key lock

## 6. M7 SERIES CONTROL EEB749

### 6.1 Interface

#### 6.1.1 Description

M7 series LED electronic control panels with touch interface for wall installation allow:

- room temperature control
- management of the main functions of the device
- temperature and humidity measurement
- fan speed regulation

They are fitted with:

- internal memory with data saving even in case of shut-down or power outage

⚠ After 20 seconds after the last action the panel brightness is reduced, only the room temperature is seen on the display.

⚠ The maximum brightness is restored to the pressure of any key.

⚠ **It is mandatory to disable the connectivity expansion module (Wi-Fi) from the Touchpad. See paragraph "Connectivity expansion module" p. 28. In case of using the app to control the unit, it must be paired with a wall control of the M series / code EFB749.**

#### 6.1.2 Display

Status and active alarms on display.

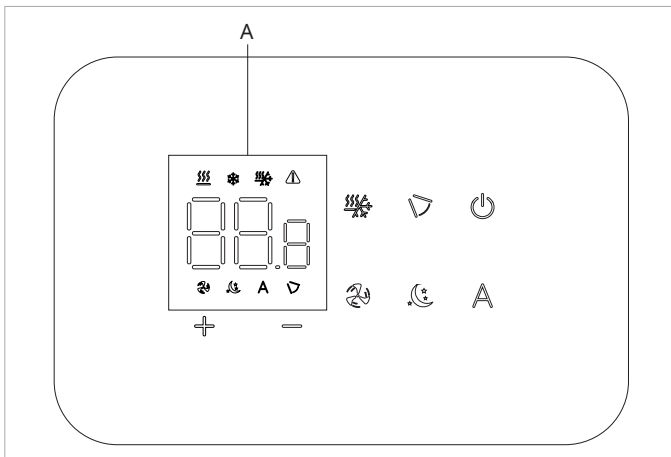

<b>A</b>	Display area
88.8	Setpoint
⚠	Alarm signals
🏠	Mobile baffle control function active (not used)
🌀	Active ventilation function
🔥❄️	Heating / Cooling (Cannot be used)
❄️	Cooling operating mode active
🔥	Heating operating mode active
⏸	Automatic function active
🌙	Night function active

#### 6.1.3 Keys functions

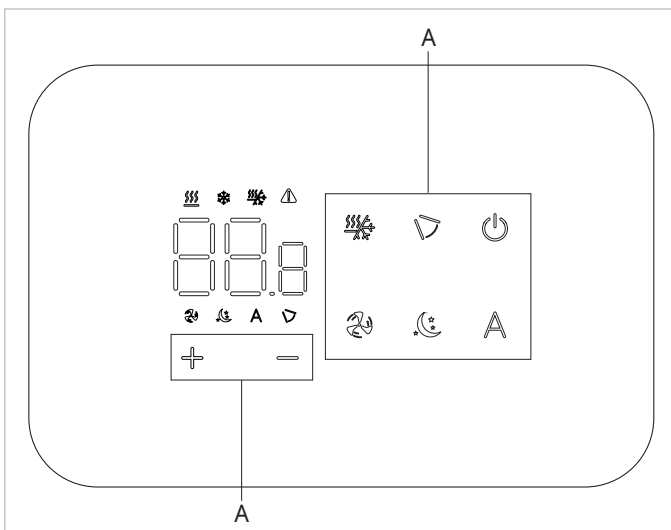

<b>A</b>	Keys area
+	Up key
-	Down key
🔌	This can be used to switch the unit on or off
🏠	Enables the mobile baffle control function (not used)
🌀	Allows you to control ventilation speed
🔥❄️	This can be used to select the operating mode (Cooling or Heating) or Autochangeover
⏸	Enables the Automatic function
🌙	Enables the Night function

## 6.2 Installation

### 6.2.1 Description

The wall-mounted remote control is an electronic LED thermostat with a touch interface, with the possibility of controlling multiple appliances equipped with the same electronic board. It is equipped with a temperature and humidity probe.

⚠ The control can manage a maximum of 16 units.

### 6.2.2 Mounting

⚠ The control panel for wall control is to be installed inside a 503 electrical box.

⚠ A wall must be prepared to accommodate the 503 electrical box before installing the wall control.

⚠ Ensure that:

- the support surface is capable of supporting the weight of the appliance
- the support surface does not affect load-bearing elements of the building, pipes, or electrical lines
- the functionality of load-bearing elements is not compromised

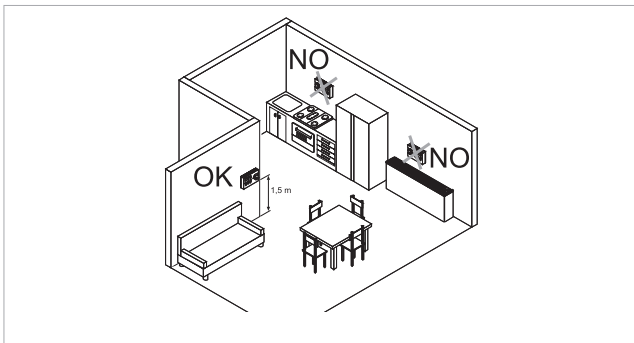

The wall-mounted remote control must be installed:

- on internal walls
- at a height of about 1,5 m from the floor

⚠ Should the control be located in an area utilised by persons with reduced physical capabilities, please refer to local regulations.

- away from doors or windows
- away from heat sources (heaters, convectors, stoves, direct sunlight)

⚠ The wall control is provided inside the package already assembled.

1. Back plate
2. Wall-mounted control panel

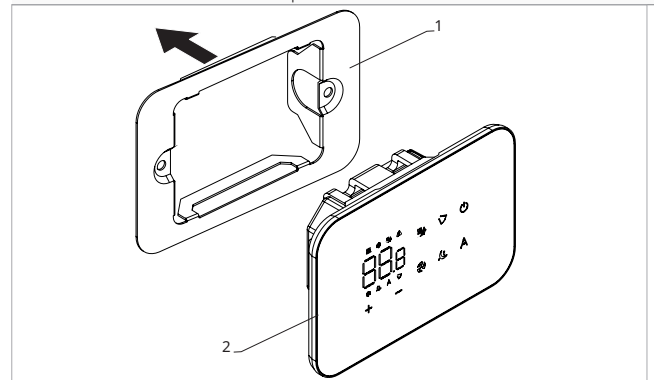

#### Before wall installation:

- ▶ separate the back plate from the control panel

1. Fixing screws
2. Back plate
3. Holes for fixing to electrical box
4. Electric box 503

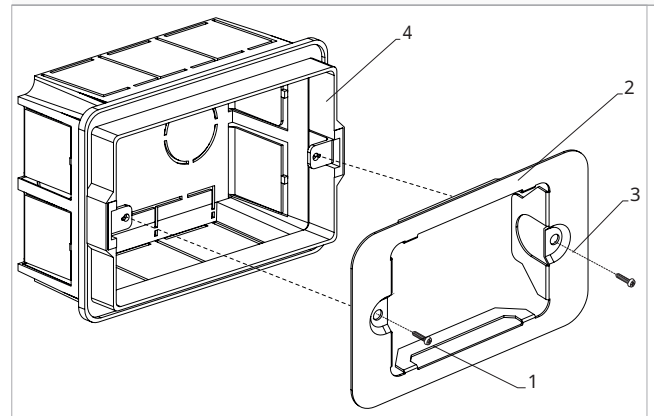

#### For wall mounting of the control panel:

- ▶ fix the control base to the electrical box 503 with screws
- ▶ connect the electrical wiring

⚠ It is mandatory to use ferrules on all conductors, both on the board side and on the wall-mounted terminal block side, to prevent permanent damage to the equipment.

#### To avoid incorrect temperature measurement:

- ▶ seal the cable entry points to prevent air from passing through
- ▶ seal all openings in the box or wall

⚠ proper sealing ensures the correct operation of the sensor and the reliability of thermal regulation

⚠ Before making the connections, please verify that the control terminal block is on the right-hand side.

# Controls

1. Electric box 503
2. Back plate
3. Wall-mounted control panel

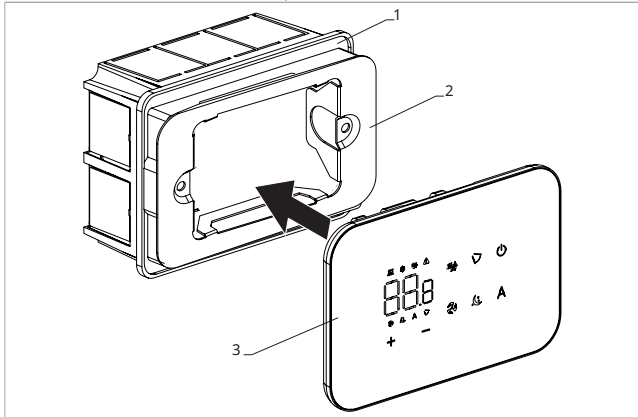

► reposition the control panel on the base

⚠ Pay attention not to crush the conductors when you close the control.

## 6.3 Single connection diagram

- 1.** M7 series wall control panel
- 2.** Terminal block for device connection
- CP** Presence contact (normally open)

- BA** Serial connection for wall-mounted remote control
- +** 12 V-DC 1A power supply
- M7** Command for wall control M7

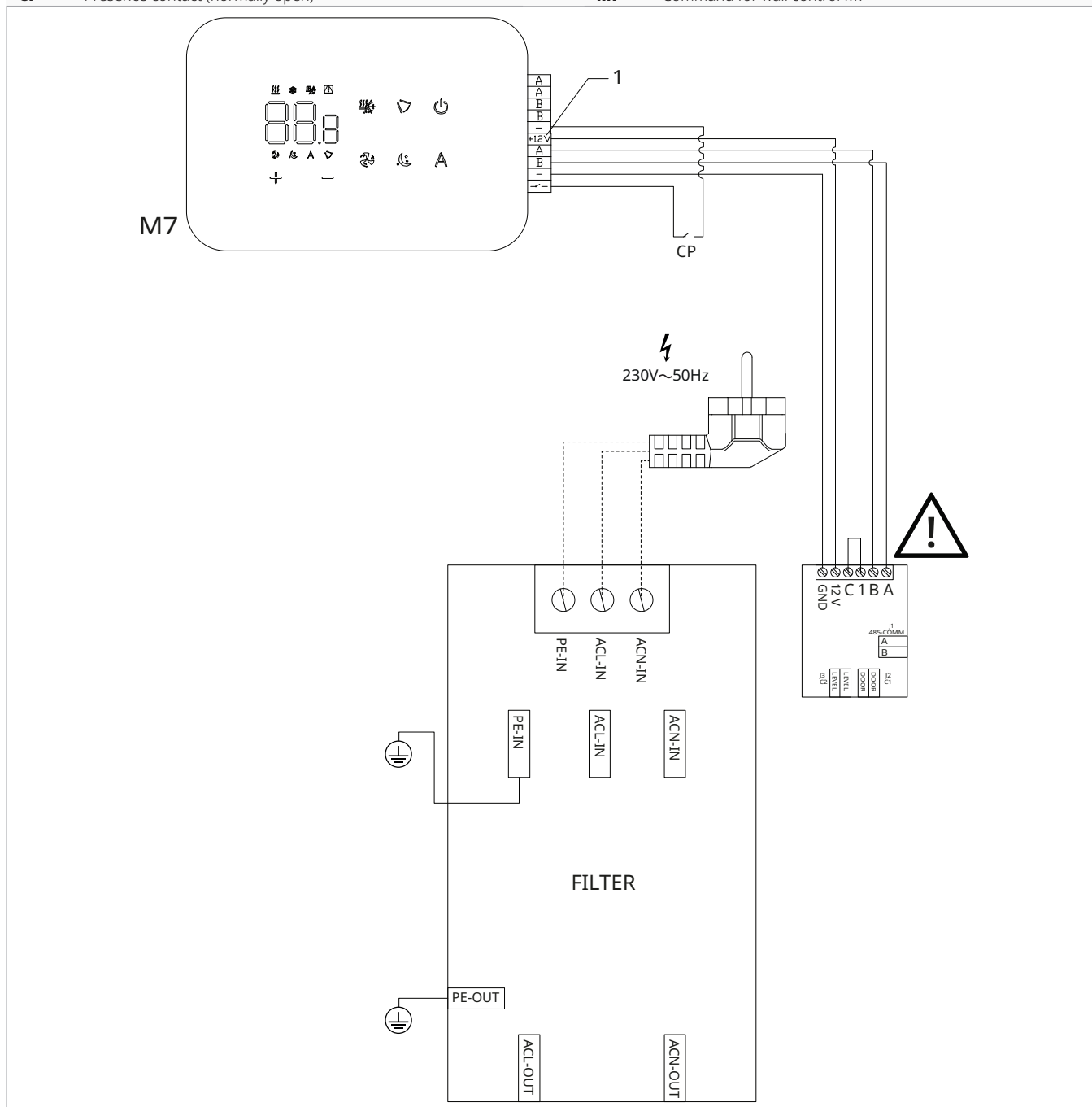

**⚠ Reverse A and B for connecting the wall control panel with the board.**

# Controls

## 6.4 Connections

### 6.4.1 Preliminary warnings

⚠ It is mandatory to use ferrules on all conductors, both on the board side and on the wall-mounted terminal block side, to prevent permanent damage to the equipment.

#### The terminals accept:

- rigid or flexible wires with a 0.2 to 1 mm<sup>2</sup> cross-section
- rigid or flexible wires with 0,5 mm<sup>2</sup> cross-section if two wires are connected to the same terminal block
- rigid or flexible wires with 0,75 mm<sup>2</sup> cross-section If the wires have wire end ferrules with a plastic collar

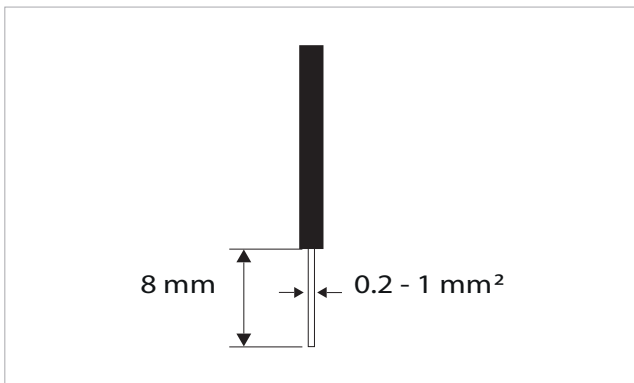

#### To connect the cables:

- ▶ strip 8 mm of the wire
- ▶ if the wire is rigid, you can insert it easily whereas
- ▶ if it is flexible, use appropriate crimp terminals
- ▶ push the wire in completely
- ▶ check the right fixing by pulling it gently

### 6.4.2 Control Panel

⚠ The control panel for wall control must be ordered separately.

#### Terminal block position:

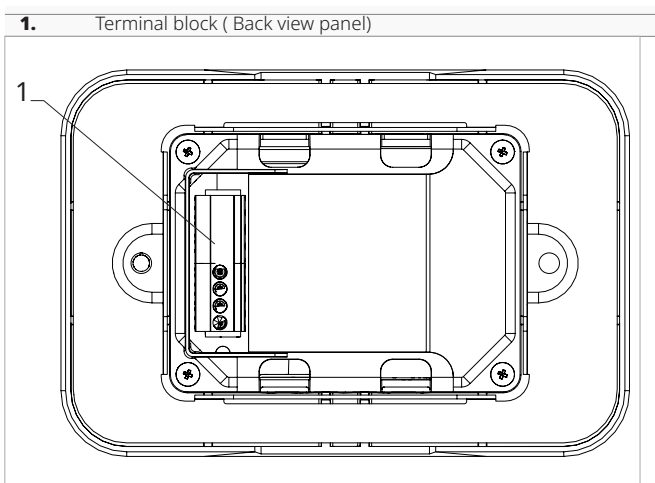

#### To make the connections:

- ▶ connect the power supply cables + and - to the GND and 12V terminals

- ▶ connect the ModBus serial connection cables to terminals A and B

⚠ Reverse A and B for connecting the wall control panel with the board.

### 6.4.3 Presence contact CP

Through this device it is possible to connect an external control signal that inhibits the operation of the control signal, for example:

- opening window contact
- remote on/off
- infrared presence sensor
- activation badge
- remote change of season

#### Function

*The contact is normally open (NO).*

- ▶ when closing the CP contact, connected to a potential-free contact, the device switches to standby mode  
*CP appears on the display.*
- ▶ At the touch of a button on the display the symbol ⚠ flashes.





⊖ It is forbidden to connect the CP input to that of another unit electronic board. Use separate contacts.

### 6.4.4 Extended display



⚠ To enable device connectivity and enable selection of fan power level, the display must be extended. See section "Extended display" p. 36.

## 6.5 Basic menu

### To access the basic menu

- ▶ with the display off, hold down  for 10 seconds  
*The device turns on and  appears*
- ▶ keep pressed until the indication  appears
- ▶ release the  key  
*The symbol  appears*

### To navigate in the menu

- ▶ use the icons  

### To select a menu item and to confirm the changes made

- ▶ press the icon   
*Confirming the change takes you to the next item.*

### To exit the menu

- ▶ press the icon  for 10 seconds
- ▶ or wait 30 seconds the automatic shutdown

 After a period of 30 seconds from the last action, the display turns off.

### 6.5.1 Menu items

**ot:** AIR probe offset (air probe setting)

**ur:** Value read by the R.H. sensor

**ut:** Probe Offset PT4

**uS:** Humidity setpoint

**uI:** Humidity hysteresis

**CF:** Scale

**ub:** Buzzer volume





**uu:** Not used

**uP:** Not used

**ho:** Hotel Mode

### 6.5.2 Set AIR probe offset





#### To set the air probe offset

- ▶ select 
- ▶ press  to change settings
- ▶ increase or decrease the value with the icons  
- ▶ press  to confirm  
*By default it is set to -2,5°C.  
The setting range is from a minimum of -12.0 °C to a maximum of 12.0 °C.*

### 6.5.3 Set probe offset RH





 Modify only after real deviations from an actual measurement has been established with professional equipment.

#### To set the RH probe offset

- ▶ select 
- ▶ press  to change settings
- ▶ increase or decrease the value with the icons  
- ▶ press  to confirm  
*By default it is set to -2.*





### 6.5.4 Set the humidity setpoint

#### To set the humidity setpoint

- ▶ select 
- ▶ press  to change settings
- ▶ increase or decrease the value with the icons  
- ▶ press  to confirm  
*By default it is set to 50.  
The setting range is from 20.0% to 90.0%.*



### 6.5.5 Setting the humidity hysteresis

#### To set the humidity hysteresis

- ▶ select 
- ▶ press  to change settings
- ▶ increase or decrease the value with the icons  
- ▶ press  to confirm  
*By default it is set to 5.  
The setting range is from 1 (min) to 30 (max).*





### 6.5.6 Scale

#### To change the temperature unit of measure

- ▶ select 
- ▶ press  to change settings
- ▶ select °C or °F
- ▶ press  to confirm  
*By default the temperature unit of measure is °C.*

### 6.5.7 Adjusting the volume

#### To change the volume

- ▶ select 
- ▶ press  to change settings
- ▶ increase or decrease the value with the icons  
- ▶ press  to confirm  
*By default it is set to 1.  
The volume setting range is from 00 (min) to 03 (max).*

 The volume changes after confirming the modification.

# Controls

## 6.5.8 Setting the Hotel Mode

### To set the Hotel mode





- ▶ select 
  - ▶ select YS to turn on Hotel mode
  - ▶ select NO to turn off the Hotel mode
- By default the device is set to NO.*

## 6.6 Advanced Menu



Through the control panel, it is possible to access the advanced menu.

**⚠ To access the advanced menu, it is first necessary to access the basic menu. See section "Basic menu" p. 35.**

### To access the advanced menu

- ▶ from the basic menu press   
*Appears *
- ▶ press the  key once  
*Appears *
- ▶ press  to confirm and log in  
*The advanced menu is accessed.*



### To navigate in the menu

- ▶ use the icons  

### To select a menu item and to confirm the changes made

- ▶ press  for 2 seconds  
*Confirming the change takes you to the next item.*

### To exit the menu

- ▶ press  for about 10 seconds  
*Appears *
- ▶ press  for about 10 seconds  
*The display turns off.*
- ▶ or wait 30 seconds after the last action  
*The display is switched off automatically.*

**⚠** After a period of 30 seconds from the last action, the display turns off.

## 6.6.1 Menu items

**Ad:** Not used

**Pr:** Not used

**di:** Options for digital input

**t1:** Not used

**rH:** Not used

**rC:** Not used

**UC:** Not used

**Ac:** Not used

**Ah:** Not used

**Ed:** Extended display

**Ab:** Enabling brightness sensor



Activating the Hotel mode:

- the Autochangeover function is deactivated
- the temperature setting range is reduced, in Cooling you can set from 22 °C to 28 °C, in Heating you can set from 16 °C to 24 °C

**Fr:** Not used

## 6.6.2 To select digital input

### To change the digital input

- ▶ select 
- ▶ press  to change settings
- ▶ select CP for presence contact (default)
- ▶ select CO to cooling open
- ▶ select CC to cooling close
- ▶ press  to confirm  
*By default digital input is set to CP.*

**⚠** For return to the default settings, set the digital input to "CP".

**⚠** By selecting one of the other inputs (CO,CC) the seasonality is locked. It is not possible to modify it through the key  of the control.

## 6.6.3 Extended display

**⚠ Allows device connectivity and enables the selection of the ventilation power level.**

**⚠** To use the ventilation speed selection, it is necessary to enable the display extension.





### To enable the display extension

- ▶ select 
- ▶ select no to disable
- ▶ select Ys to enable  
*By default, the device is set to no.*

## 6.6.4 Optical sensor

**⚠** By default, the brightness sensor is set.

### To disable the brightness sensor:

- ▶ select 
- ▶ press   
*Appear Ys.*
- ▶ press 
- ▶ select no
- ▶ press  to confirm  
*The brightness sensor is disabled.*

**⚠** The brightness sensor adapts to room lighting.

## 6.7 Alarm display on wall control panel

- ⚠ In the event of an alarm, the device still maintains active functions.
- ⚠ Alarm codes are shown on the on-board display. Refer to the "Visualization of alarms on display" *p. 29* chapter for the complete list.

## 7. M7 SERIES COMMANDS EFB749

### 7.1 Interface

#### 7.1.1 Description

M7 series LED electronic control panels with touch interface for wall installation allow:

- room temperature control
- management of the main functions of the device
- temperature and humidity measurement
- fan speed regulation

They are fitted with:

- internal memory with data saving even in case of shut-down or power outage

⚠ After 20 seconds after the last action the panel brightness is reduced, only the room temperature is seen on the display.

⚠ The maximum brightness is restored to the pressure of any key.

⚠ **It is mandatory to disable the connectivity expansion module (Wi-Fi) from the Touchpad. See paragraph "Connectivity expansion module" p. 28.**

#### 7.1.2 Display

Status and active alarms on display.

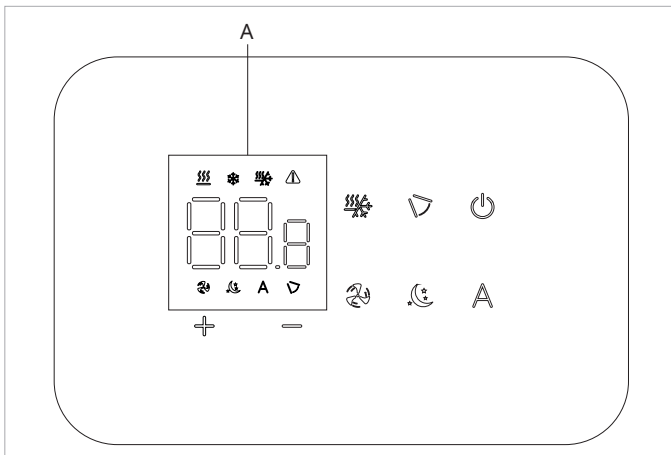

<b>A</b>	Display area
888	Setpoint
⚠	Alarm signals
🏠	Mobile baffle control function active (not used)
🌀	Active ventilation function
☀️	Heating / Cooling (Cannot be used)
❄️	Cooling operating mode active
🔥	Heating operating mode active
⏸	Automatic function active
🌙	Night function active

#### 7.1.3 Keys functions

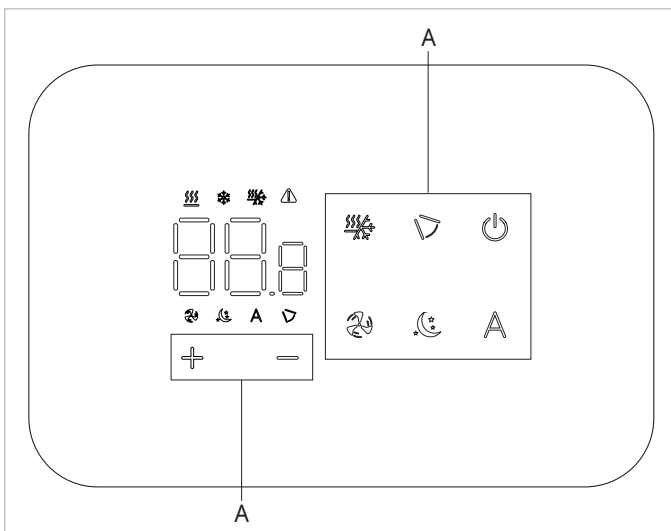

<b>A</b>	Keys area
+	Up key
-	Down key
🔌	This can be used to switch the unit on or off
🏠	Enables the mobile baffle control function (not used)
🌀	Allows you to control ventilation speed
☀️	This can be used to select the operating mode (Cooling or Heating) or Autochangeover
⏸	Enables the Automatic function
🌙	Enables the Night function

## 7.2 Installation

### 7.2.1 Description

The wall-mounted remote control is an electronic LED thermostat with a touch interface, with the possibility of controlling multiple appliances equipped with the same electronic board. It is equipped with a temperature and humidity probe.

- ⚠ The control can manage a maximum of 16 units.
- ⚠ The app "Innova" is available to control the following command.

### 7.2.2 Mounting

- ⚠ The control panel for wall control is to be installed inside a 503 electrical box.
- ⚠ A wall must be prepared to accommodate the 503 electrical box before installing the wall control.
- ⚠ Ensure that:
  - the support surface is capable of supporting the weight of the appliance
  - the support surface does not affect load-bearing elements of the building, pipes, or electrical lines
  - the functionality of load-bearing elements is not compromised

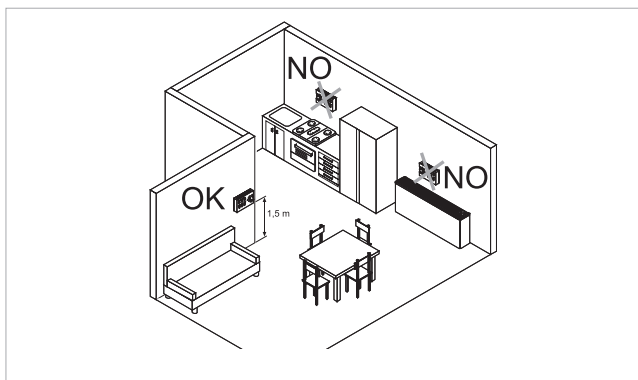

The wall-mounted remote control must be installed:

- on internal walls
- at a height of about 1,5 m from the floor
- ⚠ Should the control be located in an area utilised by persons with reduced physical capabilities, please refer to local regulations.
  - away from doors or windows
  - away from heat sources (heaters, convectors, stoves, direct sunlight)
- ⚠ The wall control is provided inside the package already assembled.

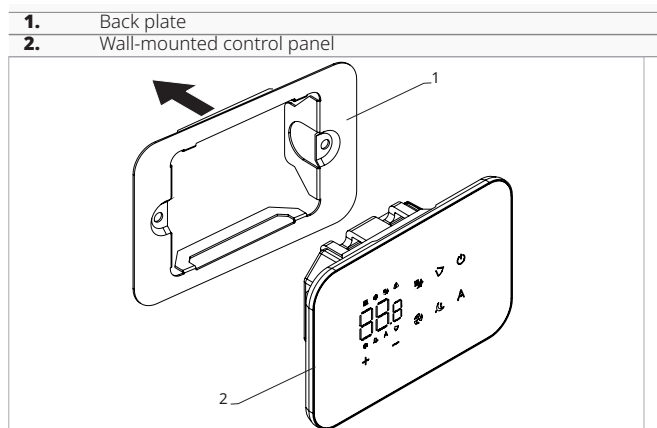

#### Before wall installation:

- ▶ separate the back plate from the control panel

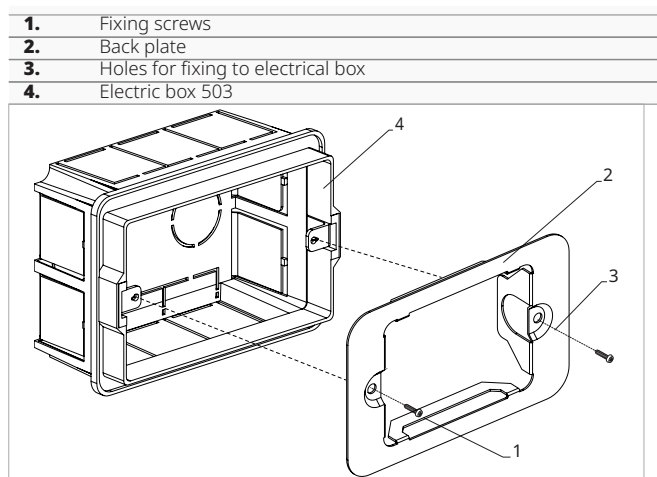

#### For wall mounting of the control panel:

- ▶ fix the control base to the electrical box 503 with screws
- ▶ connect the electrical wiring

- ⚠ It is mandatory to use ferrules on all conductors, both on the board side and on the wall-mounted terminal block side, to prevent permanent damage to the equipment.

#### To avoid incorrect temperature measurement:

- ▶ seal the cable entry points to prevent air from passing through
- ▶ seal all openings in the box or wall
- ⚠ proper sealing ensures the correct operation of the sensor and the reliability of thermal regulation
- ⚠ Before making the connections, please verify that the control terminal block is on the right-hand side.

# Controls

1. Electric box 503
2. Back plate
3. Wall-mounted control panel

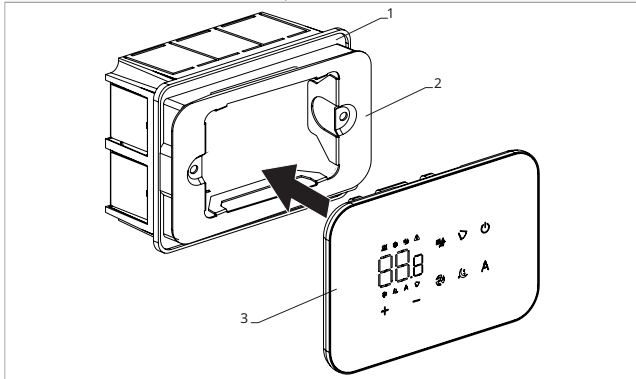

► reposition the control panel on the base

⚠ Pay attention not to crush the conductors when you close the control.

## 7.3 Single connection diagram

- 1.** M7 series wall control panel
- 2.** Terminal block for device connection
- CP** Presence contact (normally open)

- BA** Serial connection for wall-mounted remote control
- +** 12 V-DC 1A power supply
- M7** Command for wall control M7

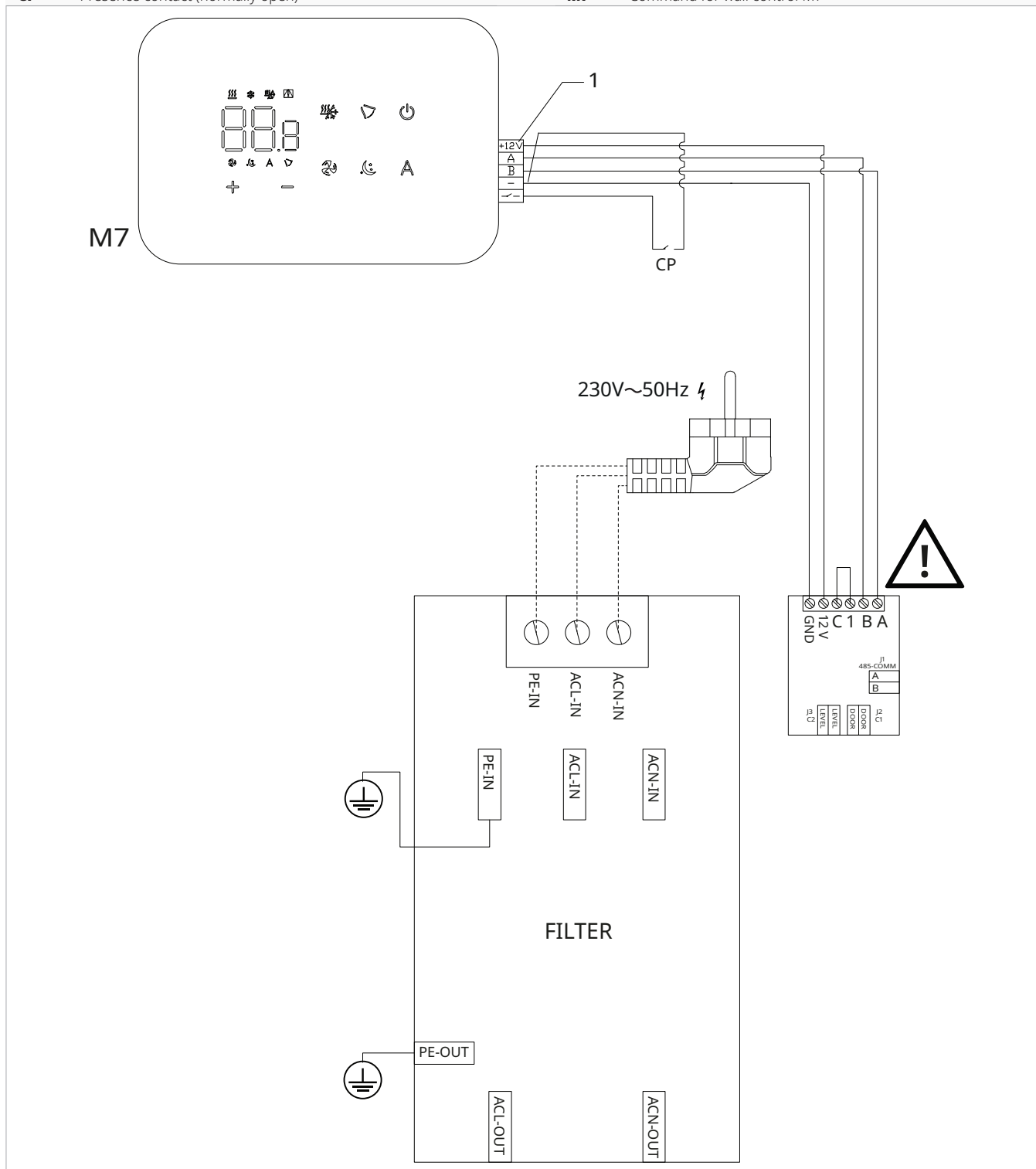

**⚠ Reverse A and B for connecting the wall control panel with the board.**

**⚠** The app "Innova" is available to control the following command.

# Controls

## 7.4 Multiple connection diagram

<b>1.</b>	M7 series wall control panel	<b>BA</b>	Serial connection for wall-mounted remote control
<b>2.</b>	Terminal block for device connection	<b>-+</b>	12 V-DC 1A power supply
<b>CP</b>	Presence contact (normally open)	<b>M7</b>	Command for wall control M7

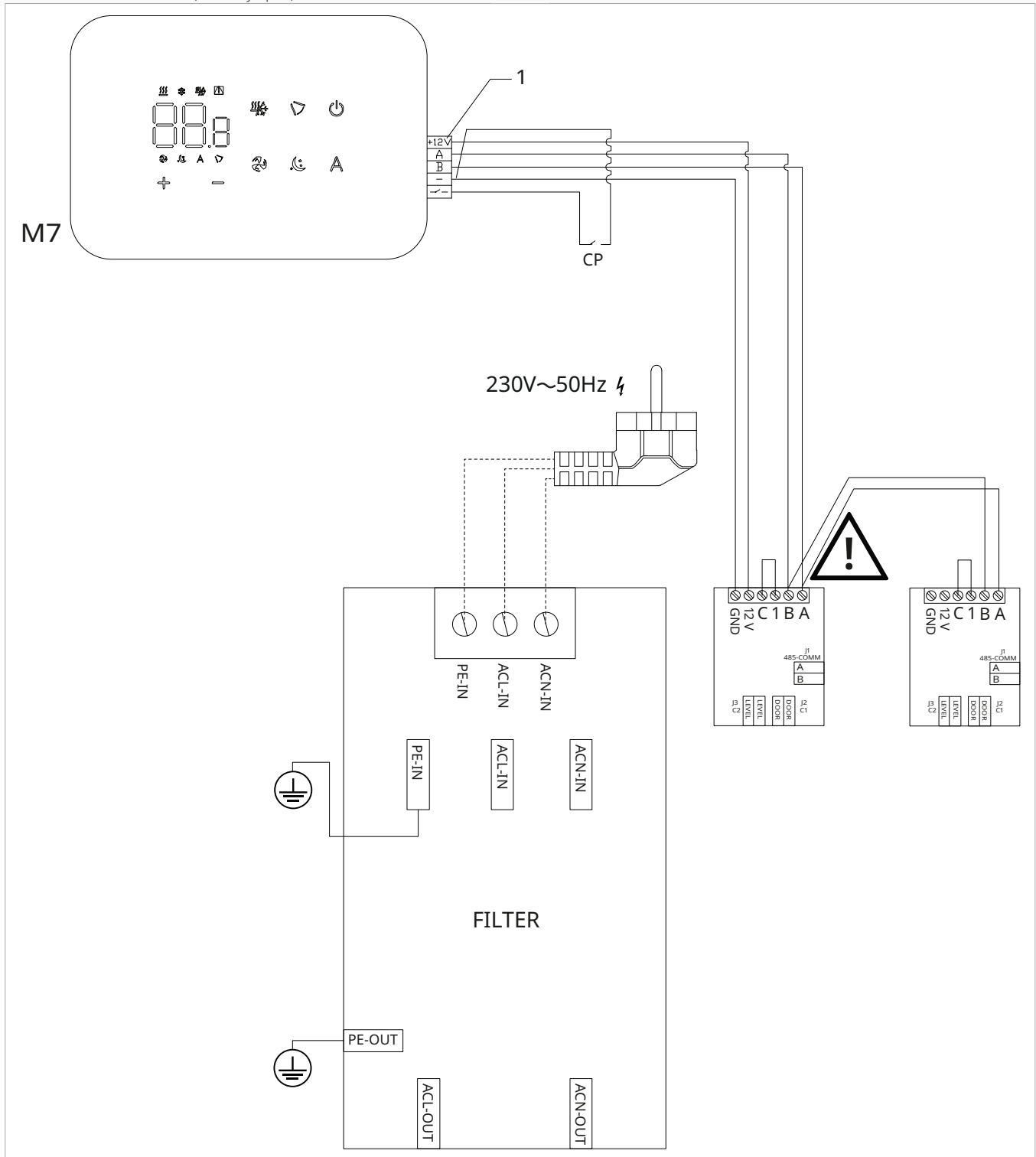

⚠ Reverse A and B for connecting the wall control panel with the boards.

⚠ For wall control code EFB749, the app is available.

## 7.5 Connections

### 7.5.1 Preliminary warnings

- ⚠ The terminals for connecting the control panel and the presence contact CP are inserted in a plastic bag and placed inside the electrical box.
- ⚠ It is mandatory to use ferrules on all conductors, both on the board side and on the wall-mounted terminal block side, to prevent permanent damage to the equipment.

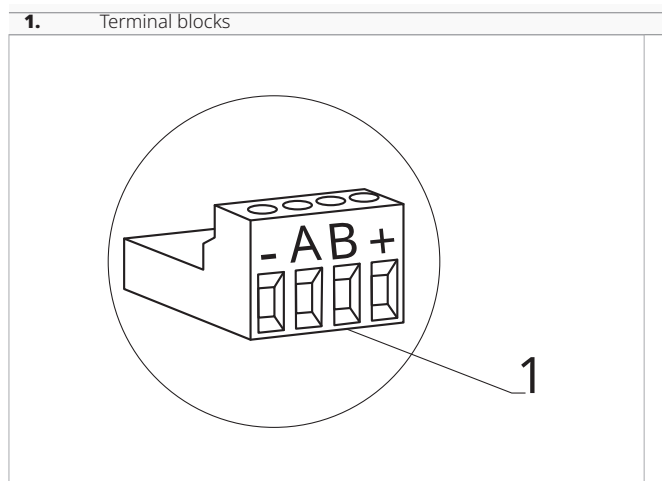

#### The terminals accept:

- rigid or flexible wires with a 0.2 to 1 mm<sup>2</sup> cross-section
- rigid or flexible wires with 0,5 mm<sup>2</sup> cross-section if two wires are connected to the same terminal block
- rigid or flexible wires with 0,75 mm<sup>2</sup> cross-section If the wires have wire end ferrules with a plastic collar

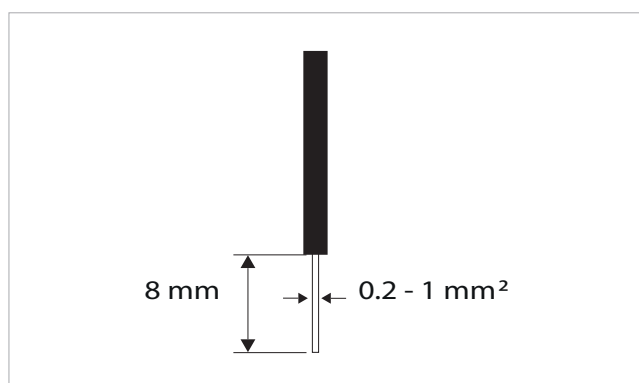

#### To connect the cables:

- ▶ strip 8 mm of the wire
- ▶ if the wire is rigid, you can insert it easily whereas
- ▶ if it is flexible, use appropriate crimp terminals
- ▶ push the wire in completely
- ▶ check the right fixing by pulling it gently

### 7.5.2 Control Panel

- ⚠ The control panel for wall control must be ordered separately.

#### Terminal block position:

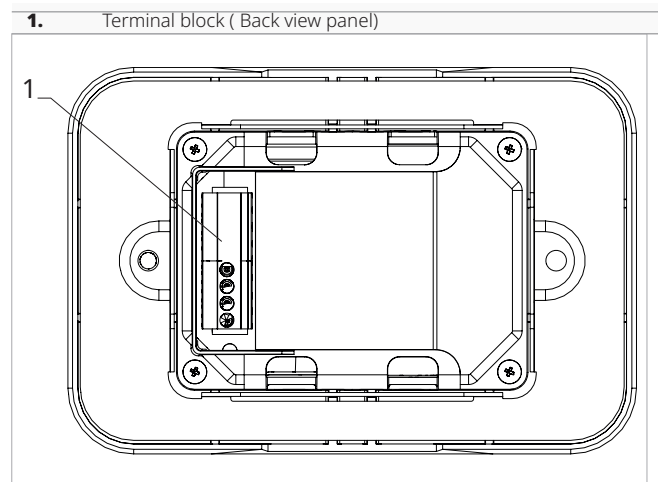

#### To make the connections:

- ▶ connect the power supply cables + and - to the GND and 12V terminals
- ▶ connect the ModBus serial connection cables to terminals A and B

- ⚠ Reverse A and B for connecting the wall control panel with the board.

### 7.5.3 Presence contact CP

Through this device it is possible to connect an external control signal that inhibits the operation of the control signal, for example:

- opening window contact
- remote on/off
- infrared presence sensor
- activation badge
- remote change of season

#### Function

*The contact is normally open (NO).*

- ▶ when closing the CP contact, connected to a potential-free contact, the device switches to stand-by mode

*CP appears on the display.*

- ▶ At the touch of a button on the display the symbol ⚠ flashes.

- ⊖ It is forbidden to connect the CP input to that of another unit electronic board. Use separate contacts.

The CP presence contact can be configured for heating and cooling operation via the "To select digital input" *p. 46* settings menu item (digital input).

### 7.5.4 RS485 Serial Connection

The wall-mounted remote control can be connected through an RS485 serial line to one or more devices, up to a maximum of 16.

The devices must be equipped with an electronic board suitable for remote control.

#### For the connection:

- ▶ follow the indication on the connection diagram
- ▶ connect respecting the polarity indication A and B

# Controls

- ⚠ Use a two core cable shielded cable suitable for the RS485 serial connection with a minimum section of 0,35 mm<sup>2</sup>.
- ⚠ Keep the two core cable separate from power supply cable by a minimum of 50 mm.
- ⚠ Create a wire path in order to minimize the length of the lead wire.
- ⚠ Complete the line with the 120 Ω resistor.

- ⊖ It is forbidden make star connections.





## 7.5.5 Extended display

- ⚠ To enable device connectivity and enable selection of fan power level, the display must be extended. See section "Extended display" p. 46.

## 7.6 Functions

### 7.6.1 Basic menu

#### To access the basic menu

- ▶ with the display off, hold down  for 10 seconds  
*The device turns on and  appears*
- ▶ keep pressed until the indication  appears
- ▶ release the  key  
*The symbol  appears*

#### To navigate in the menu

- ▶ use the icons  

#### To select a menu item and to confirm the changes made

- ▶ press the icon   
*Confirming the change takes you to the next item.*

#### To exit the menu

- ▶ press the icon  for 10 seconds
- ▶ or wait 30 seconds the automatic shutdown

- ⚠ After 30 seconds from the last action the control returns to the start screen and the last chosen values are recorded.

### Menu items

**ot:** AIR probe offset (air probe setting)

**ur:** Value read by the R.H. sensor

**ut:** Probe Offset PT4

**uS:** Humidity setpoint

**uI:** Humidity hysteresis

**CF:** Scale

**ub:** Buzzer volume





**uu:** Wi-Fi reset

**up:** Wi-Fi pairing

**ho:** Hotel Mode





### Set AIR probe offset

#### To set the air probe offset

- ▶ select 
- ▶ press  to change settings
- ▶ increase or decrease the value with the icons  
- ▶ press  to confirm  
*By default it is set to 0.  
The setting range is from a minimum of -12.0 °C to a maximum of 12.0 °C.*

### Set AIR probe offset





#### To set the air probe offset

- ▶ select 
- ▶ press  to change settings
- ▶ increase or decrease the value with the icons  
- ▶ press  to confirm  
*By default it is set to -2,5°C.  
The setting range is from a minimum of -12.0 °C to a maximum of 12.0 °C.*

### Set probe offset RH





- ⚠ Modify only after real deviations from an actual measurement has been established with professional equipment.

#### To set the RH probe offset

- ▶ select 
- ▶ press  to change settings
- ▶ increase or decrease the value with the icons  
- ▶ press  to confirm  
*By default it is set to -2.*





## Set the humidity setpoint

### To set the humidity setpoint

- ▶ select 
- ▶ press  to change settings
- ▶ increase or decrease the value with the icons  
- ▶ press  to confirm  
*By default it is set to 50.  
The setting range is from 20.0% to 90.0%.*



## Setting the humidity hysteresis

### To set the humidity hysteresis

- ▶ select 
- ▶ press  to change settings
- ▶ increase or decrease the value with the icons  
- ▶ press  to confirm  
*By default it is set to 5.  
The setting range is from 1 (min) to 30 (max).*





## Scale

### To change the temperature unit of measure

- ▶ select 
- ▶ press  to change settings
- ▶ select °C or °F
- ▶ press  to confirm  
*By default the temperature unit of measure is °C.*

## Adjusting the volume



### To change the volume

- ▶ select 
- ▶ press  to change settings
- ▶ increase or decrease the value with the icons  
- ▶ press  to confirm  
*By default it is set to 1.  
The volume setting range is from 00 (min) to 03 (max).*

 The volume changes after confirming the modification.











## Factory reset

### To reset the factory parameters

- ▶ select 
- ▶ press  to change settings
- ▶ select No to keep current parameters
- ▶ select Yes to reset the factory parameters
- ▶ press  to confirm  
*By default digital input is set to No.*











## Wi-Fi reset

### To reset the Wi-Fi credentials and return the device to its original configuration

- ▶ select 
- ▶ press  to change settings
- ▶ use the   icons in sequence  
*Appears  .*
- ▶ press 
- ▶   appears to reset Wi-Fi credentials.
- ▶ press  to confirm  
*Credentials have been reset.*

## Activate Wi-Fi

### To activate Wi-Fi

- ▶ select 
- ▶ press  to change settings
- ▶ use the   icons in sequence  
*Appears  .*
- ▶ press 
- ▶  appears to enable Wi-Fi pairing.
- ▶ press  to confirm  
* appears, Wi-Fi is active.*

 The device remains visible on the App for the first 15 minutes after the device is switched on.

## Setting the Hotel Mode

### To set the Hotel mode

- ▶ select 
- ▶ select YES to turn on Hotel mode
- ▶ select NO to turn off the Hotel mode  
*By default the device is set to NO.*

Activating the Hotel mode:





- the Autochangeover function is deactivated
- the temperature setting range is reduced, in Cooling you can set from 22 °C to 28 °C, in Heating you can set from 16 °C to 24 °C

## 7.6.2 Advanced Menu

 To access the setup menu, it is necessary to access the Basic menu. See section "Basic menu" p. 44.



The special functions menu can be accessed via the control panel.

### To access the advanced menu

- ▶ from the basic menu press 
- ▶ *Appears .*
- ▶ press the  key once  
*Appears .*

- ▶ press  to confirm and log in  
*The advanced menu is accessed.*

### To navigate in the menu



- ▶ use the icons  

### To select a menu item and to confirm the changes made

- ▶ press  for 2 seconds  
*Confirming the change takes you to the next item.*

# Controls

## To exit the menu

- ▶ press  for about 10 seconds  
*Appears .*
- ▶ press  for about 10 seconds  
*The display turns off.*
- ▶ or wait 30 seconds after the last action  
*The display is switched off automatically.*

 After 30 seconds from the last action the control returns to the start screen and the last chosen values are recorded.

## Menu items

**Ad:** Not used

**Pr:** Not used

**di:** Options for digital input

**t1:** Not used

**rH:** Not used

**rC:** Not used

**UC:** Not used

**Ac:** Not used

**Ah:** Not used



**Ed:** Extended display

**Ab:** Enabling brightness sensor



**Fr:** Not used

## To select digital input

### To change the digital input

- ▶ select  i
- ▶ press  to change settings
- ▶ select CP for presence contact (default)
- ▶ select CO to cooling open
- ▶ select CC to cooling close
- ▶ press  to confirm  
*By default digital input is set to CP.*

 For return to the default settings, set the digital input to "CP".

 By selecting one of the other inputs (CO,CC) the seasonality is locked. It is not possible to modify it through the key  of the control.

## Extended display

 **Allows device connectivity and enables the selection of the ventilation power level.**

 To use the ventilation speed selection, it is necessary to enable the display extension.





## To enable the display extension

- ▶ select 
- ▶ select no to disable
- ▶ select Ys to enable  
*By default, the device is set to no.*

## Optical sensor

 By default, the brightness sensor is set.

### To disable the brightness sensor:

- ▶ select 
- ▶ press   
*Appear Ys.*
- ▶ press 
- ▶ select no
- ▶ press  to confirm  
*The brightness sensor is disabled.*

 The brightness sensor adapts to room lighting.

## 7.6.3 Alarm display on wall control panel

 In the event of an alarm, the device still maintains active functions.

 Alarm codes are shown on the on-board display. Refer to the "Visualization of alarms on display" *p. 29* chapter for the complete list.

## 8. MAINTENANCE

Routine maintenance is essential to keep the device efficient, safe, and reliable over time.

### 8.1 Preliminary warnings

#### Before each cleaning and maintenance intervention:

- ▶ disconnect the device from the power supply by turning the system main switch to "OFF"
- ▶ wait for the components to cool down in order to avoid any burns
- ⊖ Carrying out any technical or cleaning work before disconnecting the unit from the power supply is forbidden.
- ⚠ Make sure that there is no voltage before servicing.
- ⚠ After completing the maintenance work, the unit must be restored its original condition.
- ⚠ Handle refrigerant with care. Leaking refrigerant can cause freezing.

#### 8.1.1 Specific warnings R32

- ⚠ R32 refrigerant gas is mildly flammable and odourless.
- ⚠ Check that there are no sources of ignition in continuous operation (open flames, gas appliances, electric stoves, lighted cigarettes, etc.).
- ⊖ Smoking in the vicinity of the appliance is prohibited.
- ⊖ Using a mobile phone near the appliance is prohibited.
- ⊖ Using leak detectors with halogen lamps is prohibited.

### 8.2 Routine maintenance

The routine maintenance plan includes the following cleaning operations.

Carry out cleaning:  
• every six months

#### 8.2.1 External cleaning

Clean the external surfaces with a soft damp cloth.

- ⚠ Disconnect the unit from the power supply before each cleaning and maintenance intervention by setting the main power supply switch to off.
- ⚠ Do not use abrasive sponges, or abrasive or corrosive detergents, as you might damage the painted surfaces.

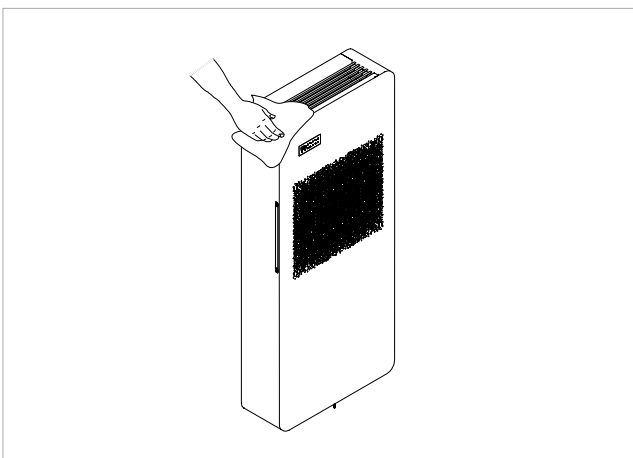

#### 8.2.2 Cleaning the filters

Clean the air filter after a period of continuous use and according to the concentration of impurities in the air, or

when you wish to start-up the appliance after a period of inactivity.

- ⚠ The filter is located in the bottom part of the appliance.

# Maintenance

- ⚠ Wait for the components to cool down in order to avoid any burns.
- ⚠ Pay attention to the sharp edges.
- ⚠ For disassembly operations, see chapter "Disassembly and assembly of cosmetic panels and grilles" *p. 25*.

- ⚠ Disconnect the connector when opening the front panel.
- ⚠ Do not use detergents or solvents.
- ⚠ After filter cleaning check if the panel is properly mounted.
- 🚫 It is forbidden to use the device without mesh filter.

- |    |               |
|----|---------------|
| 1. | Upper grille  |
| 2. | Fixing screws |
| 3. | Crossbar      |

- |    |                       |
|----|-----------------------|
| 4. | Aesthetic front panel |
| 5. | Filter                |
| 6. | Connectors            |

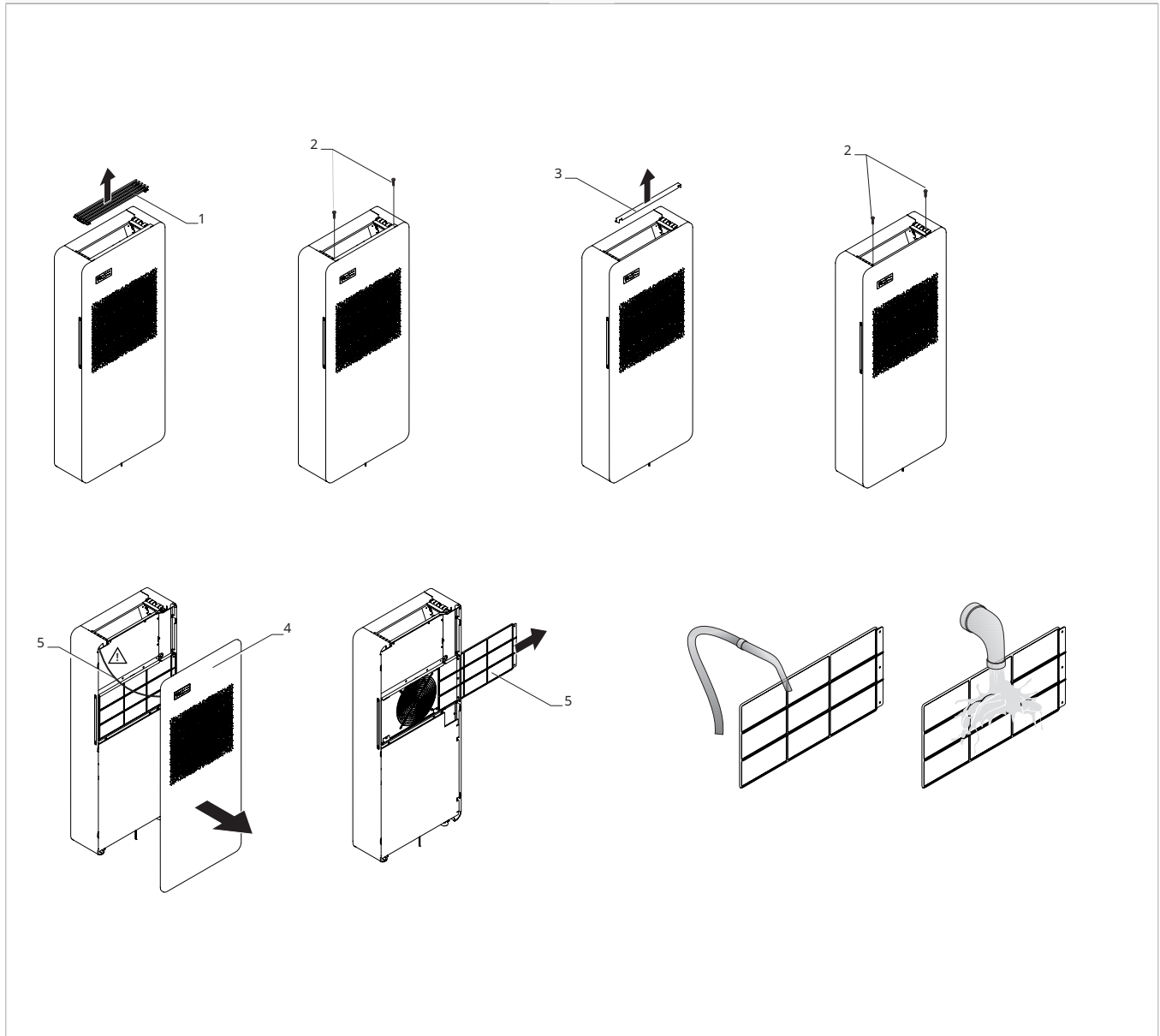

## To clean the filter:

- ▶ slide the filter sideways out of its housing
- ▶ remove the dust from the filter with a vacuum cleaner or by washing it in running water
- ▶ allow it dry
- ▶ reinstall the filter, paying particular attention to positioning it correctly

## 9. TROUBLESHOOTING

### 9.1 Troubleshooting table

In the event of a malfunction, please refer to the following table. If, after performing the suggested checks, the prob-

lem is not solved, please contact the Authorised Technical Assistance.

Anomalies	Possible causes	Remedies
The appliance doesn't switch on	No power supply	Check there is power supply (by turning a light on, for example). Check that the thermal-magnetic circuit breaker used exclusively to protect the appliance has not been tripped (if it has, reset it). If the problem repeats immediately, please call the Service Centre and avoid trying to make the appliance work.
	Remote control batteries have run out	Check that the appliance can be turned on using the touch-screen display and substitute the batteries.
The appliance does not cool/heat adequately.	The set temperature is too high or too low.	Check and, if necessary, adjust the temperature setting on the remote control
	The air filter is clogged	Check the air filter and clean it if necessary
	Check that there are no other obstacles to the air flow both inside and outside the appliance.	Remove anything that might block the air flow.
	The heating and cooling load has increased (for example, a door or a window has been left open or an appliance has been installed in the room which generates a lot of heat).	Try to reduce the heating and cooling load of the room following instructions below: Cover large windows exposed to sunlight with curtains or with external maskings (blinds, porches, reflecting films, etc.); The air conditioned room must remain closed for as long as possible; Avoid turning on halogen lamps or other high energy consumption appliances such as small ovens, steam irons, hot plates etc.).

### 9.2 Diagnosis of possible anomalies

If the conditioner blocks because of an alarm (see following table), please communicate to the assistance centre the code on the display to facilitate interventions.

#### 9.2.1 Open CP contact

If the presence contact is not closed, the appliance will not start and the CP alarm appears on the display.

⚠ Please refer to chapter "CP occupancy contact input connection" p. 24.

#### 9.2.2 Maximum condensate collection level warning

In heating operation, condensate drains free through the appropriate pipe.

In case of an OF alarm, check that the condensation drain line is not bent or obstructed to prevent water from draining out.

In cooling or dehumidification function, in extreme operating condition (high temperature and high humidity) the unit may not be able to automatically dispose of the produced condensate, in this case the display will show OF. The OF sign, is not an error, but an alarm indicating that the water has reached the maximum level of the condensate drip tray.

In this case, it is necessary to drain the condensate manually:

- ▶ place a drip pan (not provided) below the condensate drain pipe
- ▶ drain the water using the cap on the condensate drain pipe

⚠ If after performing the procedure, the OF alarm remains, you should contact the Technical Service Center.

#### 9.2.3 Use of the appliance

⚠ Objects or structural obstacles (furniture, curtains, plants, leaves, blinds, etc.) must not obstruct the normal air flow both from the internal and from the external grilles.

⚠ Do not lean against, or worse sit on, the body of the conditioner, this would damage the appliance.

⚠ Do not move the horizontal air outlet flap manually. Always use the remote control to perform such operation.

⚠ In the event of water leaks, turn off the appliance and disconnect the electric power supply. Call the nearest service centre.

⚠ During heating mode, the conditioner eliminates periodically any ice formed on the external battery. In such situation, the machine keeps on working, but it does not dispense warm air to the room. This phase can last from 3 up to maximum 10 minutes.

# Fault Finding

⚠ The appliance must not be installed in rooms where explosive gases develop or where there are humidity and temperature conditions that exceed the maximum levels reported on the installation manual.

⚠ Clean the air filter regularly as described in the specific paragraph.

## 9.3 Visualization of alarms on display

Code	Alarm description	Solution
Er01	Room temperature probe error (RT)	If the alarm does not automatically reset, disconnect and reconnect the power supply. If the alarm does not reset, contact the Authorised Service Centre.
Er02	Error of the temperature sensor of the internal heat exchanger (IPT)	If the alarm does not automatically reset, disconnect and reconnect the power supply. If the alarm does not reset, contact the Authorised Service Centre.
Er03	Error outdoor air temperature probe (OT)	If the alarm does not automatically reset, disconnect and reconnect the power supply. If the alarm does not reset, contact the Authorised Service Centre.
Er04	Error of the external heat exchanger temperature probe (OPT)	If the alarm does not automatically reset, disconnect and reconnect the power supply. If the alarm does not reset, contact the Authorised Service Centre.
Er05	Malfunctioning of the internal fan	Disconnect and restore power to the appliance. If the malfunction persists, contact the Authorised Service Centre.
Er06	Malfunction of the external fan	Disconnect and restore power to the appliance. If the malfunction persists, contact the Authorised Service Centre.
Er07	Driver communication error	Disconnect and restore power to the appliance. If the malfunction persists, contact the Authorised Service Centre.
Er08	Compressor discharge temperature probe (TD) error	If the alarm does not automatically reset, disconnect and reconnect the power supply. If the alarm does not reset, contact the Authorised Service Centre.
Er09	Communication error with remote thermostat M7	Check that thermostat M7 is switched on and that the set functions are activated on the appliance. Otherwise, contact the Authorised Service Centre.
OF	Maximum level float intervention in the condensate drip tray (ALARM)	The condensate drain is not functioning properly, contact the Authorised Service Centre
CP	Open (CP) contact	Open contact. The appliance only switches on when the contact is closed, check the terminal connection.
Er12	Driver error - compressor failure	Disconnect and restore power to the appliance. If the malfunction persists, contact the Authorised Service Centre.
CE	Communication error between main circuit board and display	You cannot see the function on the display, please contact the Authorised Service Centre.
Er16	4-way valve management error or alarm for insufficient refrigerant charge	Disconnect and restore power to the appliance. If the malfunction persists, contact the Authorised Service Centre.
Er17	Driver parameter error or compressor incompatibility	Disconnect and restore power to the appliance. If the malfunction persists, contact the Authorised Service Centre.
Er19	Heating element safety temperature probe error (LEVEL)	If the alarm does not automatically reset, disconnect and reconnect the power supply. If the alarm does not reset, contact the Authorised Service Centre.
Er20	Error of the second temperature probe of the external heat exchanger (GT)	If the alarm does not automatically reset, disconnect and reconnect the power supply. If the alarm does not reset, contact the Authorised Service Centre.
Er22	Wrong power supply	Disconnect and restore power to the appliance. If the malfunction persists, contact the Authorised Service Centre.
BL	Key lock	To unlock the display, press simultaneously + for 3 seconds.

## 10. TECHNICAL INFORMATION

### 10.1 Technical data

Models		u.m.	12 HP 230 V	15 HP 230 V	15 HP ELEC
<b>Cooling performance (AT 35°C; AT 27°C)</b>					
Maximum cooling capacity Dual Power	(1)	kW	2,58	2,84	2,84
Nominal cooling capacity	(1)	kW	2,29	2,72	2,72
Minimum Cooling Capacity	(1)	kW	0,81	1,15	1,15
Dehumidification capacity		L/h	0,73	0,79	0,79
Rated power consumption		kW	0,73	1,02	1,02
EER			3,10	2,70	2,70
Energy efficiency class	(2)		A+	A	A
<b>Heating performance (AT 7°C; AT 20 °C)</b>					
Maximum heat output Dual Power	(3)	kW	2,65	2,90	2,90
Nominal heat power	(3)	kW	2,36	2,70	2,70
Electric heater additional power		kW	-	-	0,90
Minimum heat output	(3)	kW	0,80	1,15	1,15
Rated power consumption		kW	0,66	0,77	0,77
COP			3,60	3,50	3,50
Energy class			A+	A	A
<b>Electrical data</b>					
total input power		kW	0,98	1,06	1,96
Maximum absorbed current		A	4,30	4,60	8,50
Power Supply		V/ph/Hz	230/1/50	230/1/50	230/1/50
<b>Aeraulic data indoor (4)</b>					
Ventilation speed	(5)	Nr.	3+2	3+2	3+2
<b>General characteristics</b>					
Type of compressor			Rotary DC Inverter	Rotary DC Inverter	Rotary DC Inverter
Maximum indoor/outdoor air flow rate		m <sup>3</sup> /h	450/680	500/700	500/700
Average indoor/outdoor air flow rate		m <sup>3</sup> /h	360/500	380/510	380/510
Minimum internal/external air flow rate		m <sup>3</sup> /h	280/320	280/320	280/320
<b>Sound data</b>					
Nominal sound pressure	(6)	dB(A)	43	45	45
Minimum sound pressure level	(6)	dB(A)	29	29	29
Maximum sound power level	(7)	dB(A)	58	60	60
<b>Refrigerant gas data</b>					

1. Outdoor air temperature 35 °, relative humidity 41%. Ambient temperature 27 ° C; relative humidity 47%. Performance according to EN 14511
2. Energy Efficiency according to Directive 626/2011- Valid for tax deduction
3. Fresh air temperature 7 °C, relative humidity 87%. Room temperature 20°C, relative humidity 59% (max). Performance according to UNI 14511
4. Efficiency according to UNI EN 13141-7 Indoor temperature 20 °C - Indoor humidity 28 % - Outdoor temperature 7 °C - Outdoor humidity 72 %
5. 3 manual speed + auto speed + boost speed.
6. Internal side sound pressure measured in semi-anechoic chamber at a distance of 2 m.
7. Internal sound power measured in a semi-anechoic chamber according to EN 12102-1

# Technical Data

Models	u.m.	12 HP 230 V	15 HP 230 V	15 HP ELEC
Type of refrigerant		R32	R32	R32
Quantity of refrigerant	kg	0,57	0,57	0,57

1. Outdoor air temperature 35 °, relative humidity 41%. Ambient temperature 27 ° C; relative humidity 47%. Performance according to EN 14511
2. Energy Efficiency according to Directive 626/2011- Valid for tax deduction
3. Fresh air temperature 7 °C, relative humidity 87%. Room temperature 20°C, relative humidity 59% (max). Performance according to UNI 14511
4. Efficiency according to UNI EN 13141-7 Indoor temperature 20 °C - Indoor humidity 28 % - Outdoor temperature 7 °C - Outdoor humidity 72 %
5. 3 manual speed + auto speed + boost speed.
6. Internal side sound pressure measured in semi-anechoic chamber at a distance of 2 m.
7. Internal sound power measured in a semi-anechoic chamber according to EN 12102-1

## Reference conditions

		Environment T	External T
(1)	Cooling mode tests (EN 14511)	DB 27 °C - WB 19 °C	DB 35 °C - WB 24 °C
(2)	Heating mode tests (EN 14511)	DB 20 °C - WB 15 °C	DB 7 °C - WB 6 °C
(3)	Heating mode tests	DB 20 °C - WB 15 °C	DB -7 °C - WB -8 °C
(4)	Internal side sound pressure measured in semi-anechoic chamber at a distance of 2 m.		
(5)	Internal side sound pressure measured in accordance with regulation EN 12012		

## Operating limits

	Room temperature T	External temperature T
Maximum operating temperature in cooling mode	32 °C	43 °C
Minimum operating temperature in cooling mode	18 °C	-5 °C
Maximum operating temperatures in heating mode	25 °C	18 °C
Minimum operating temperatures in heating mode	5 °C	-15 °C (-25 °C for ELEC versions)

## 10.2 Dimensions

Models	u.m.	..2.0 Verticale		..2.0 Verticale ELEC
		12 HP 230 V	15 HP 230 V	15 HP ELEC
<b>Product dimensions and weight</b>				
Width	mm	580	580	580
Height	mm	1.330	1.330	1.330
Total depth	mm	205	205	205
Wall hole diameter	mm	202	202	202
Wall holes distance	mm	293	293	293
Empty weight	kg	63,0	63,0	63,0

## 10.3 Installation template

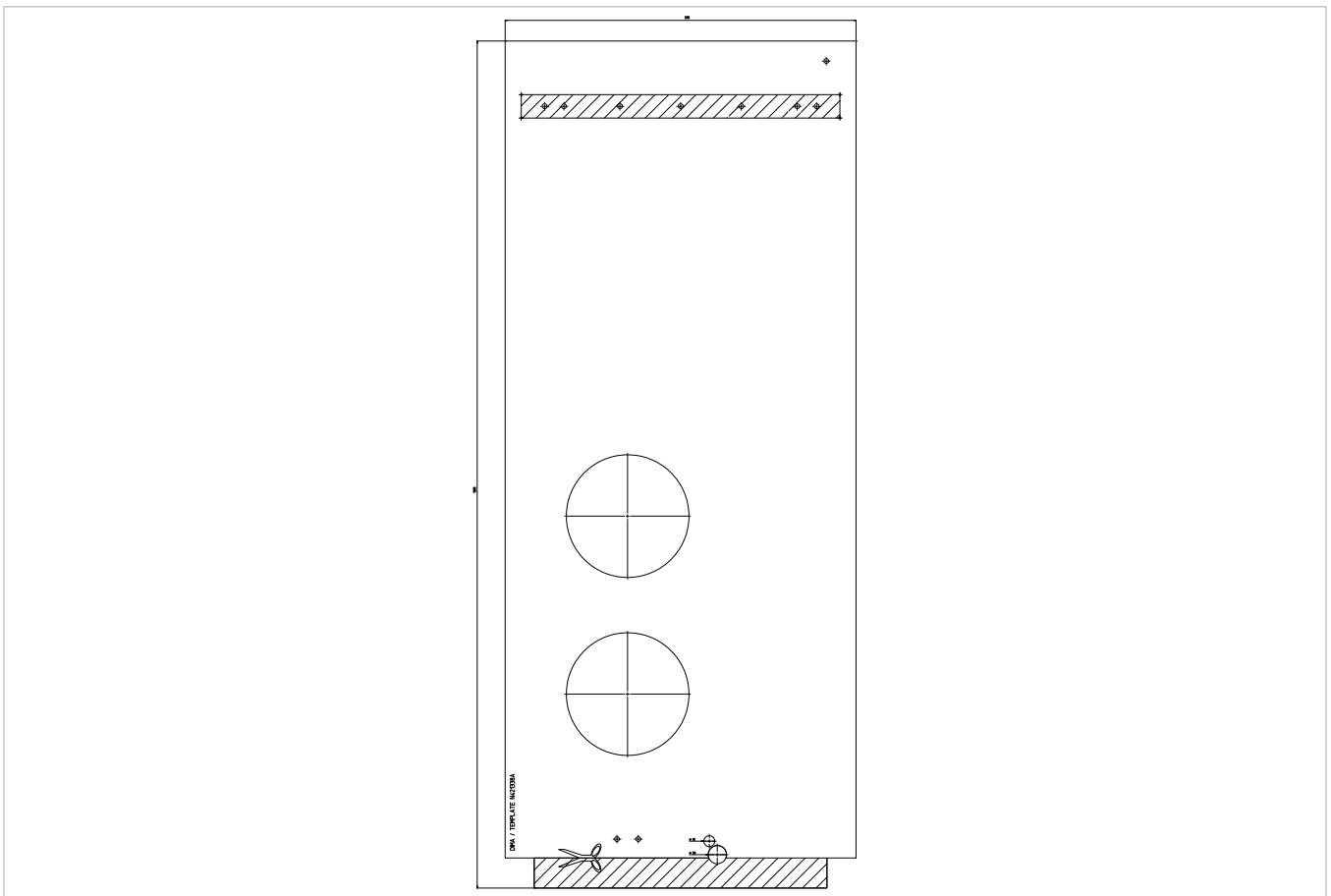

## 10.4 Safety

This equipment is designed with the utmost care for the safety of those who install and use it. However, special attention must be paid to the dangers of electric shock and static electricity when working with electrical equipment.

All guidelines must therefore be allowed at all times to ensure safe use of the equipment.

## 10.5 RED Compliance Statement

### Compliance with 2014/53/EU Radio Equipment Directive (RED).

In accordance with Article 10.8(a) and 10.8(b) of the RED, the following table provides information on the frequency

bands used and the maximum RF transmit power of the product for sale in the EU:

Frequency range (MHz)	Max. Transmit Power
2400-2472	< 20

Hereby, the company declares that the device is in compliance with Directive 2014/53/EU.

This equipment should be installed and operated with a minimum distance of 20 centimeters between the radiator and your body.

⚠ For declarations of conformity, certificates and other certification details please consult the website.

## 10.6 FCC Declaration of Conformity

This equipment complies with FCC radiation exposure limits set forth for an uncontrolled environment.

# Technical Data

To avoid the possibility of exceeding the exposure limits, maintain a distance of not less than 0.5 cm between the antenna and the person during normal operation.

## 10.6.1 Warnings

- ⚠ This wireless device uses and can radiate radio frequency energy and, if not installed and used in accordance with the instructions, may cause harmful interference to radio communications.
- ⚠ This device must not be placed or used in conjunction with any other antenna or transmitter.
- ⚠ This equipment complies with the limits for a Class B digital device, pursuant to FCC Rules.
- ⚠ The limits are designed to provide reasonable protection against harmful interference in a residential installation.

## 10.6.2 Notes on Wi-Fi communication

This equipment complies with the limits for a Class B digital device, pursuant to FCC Rules.

In case of interference:

- increase the distance between the object and the receiver
- immediately contact an Authorised Service Centre or suitably qualified personnel

## EU countries intended for use

The version of this device is intended for home and business use in Austria, Belgium, Bulgaria, Cyprus, Czech Republic, Denmark, Estonia, Finland, France, Germany, Greece, Hungary, Ireland, Italy, Latvia, Lithuania, Luxembourg, Malta, the Netherlands, Poland, Portugal, Romania, Slovakia, Slovenia, Spain, Sweden, Turkey and the United Kingdom and is also authorised in the EFTA Member States: Iceland, Liechtenstein, Norway and Switzerland.

## EU countries not intended for use

None.





## Getting In Touch

Powrmatic Limited  
Hort Bridge, Ilminster  
Somerset  
TA19 9PS  
tel: **+44 (0) 1460 53535**  
fax: **+44 (0) 1460 52341**  
e-mail: **info@powrmatic.co.uk**  
web: **www.powrmatic.co.uk**



Powrmatic Ireland  
45 Broomhill Close  
Tallaght  
Dublin 24  
tel: **+353 (0) 1452 1533**  
fax: **+353 (0) 1452 1764**  
e-mail: **info@powrmatic.ie**  
web: **www.powrmatic.ie**

More information is available from our website by scanning the following QR code.



Powrmatic pursues a policy of continuous improvement in both design and performance of its products and therefore reserves the right to change, amend or vary specifications without notice. Whilst the details contained herein are believed to be correct they do not form the basis of any contract and interested parties should contact the Company to confirm whether any material alterations have been made since publication of this brochure.