

POWRMATIC®

Vision

User Manual

Issue 1.2 June 2021



Certificate Of Guarantee

POWRMATIC®

Certificate of Guarantee

This is to certify that this air conditioner has a parts only one year warranty from the date of original installation.

To make a claim

In the first instance you must contact your appliance supplier, or installer and provide:-

1. The appliance type and serial number.
2. A copy of the registration documentation. As much detail as possible on the fault.
3. Your supplier, or installer, will then contact Powrmatic to make a guarantee claim on your behalf.

Conditions of Guarantee

1. The air conditioner must have been installed by a competent installer, and in accordance with the manufacturer's instructions and any building regulations and local regulations.
2. A copy of the registration form must be returned to Powrmatic.
3. The air conditioner has been maintained on a yearly basis by a competent and qualified servicing company.
4. The air conditioner has been used in accordance with the manufacturer's instructions.
5. The correct specification voltage has been used.
6. No unauthorised repairs or modifications have been made. Powrmatic 'General Conditions of Sales' have been observed.
7. Except for the obligation of Powrmatic Ltd to perform warranty repairs during the guarantee period, Powrmatic will not be liable in respect of any claim for direct or indirect consequential losses, including loss of profits or increased cost arising from loss of use of the heater, or any event arising there from.

Exclusions

Consumables such as control batteries are all excluded from guarantee.

Powrmatic Ltd, Hort Bridge, Ilminster, Somerset, TA19 9PS
Tel: 01460 53535 **Fax: 01460 52341**
Web: www.powrmatic.co.uk **e-mail: warranty@powrmatic.co.uk**

**Important: This certificate
must be kept with the appliance**

Failure to provide a copy of the commissioning sheet invalidates the heater warranty

Dear Customer - thank you for choosing Powrmatic..

We appreciate you buying one of our high quality products and know that you have made the best choice. By choosing Powrmatic, you are investing in UK manufacturing & its workforce. We pride ourselves by manufacturing products that provide clean, comfortable and safe working environments worldwide together with the personal & professional service and back-up you deserve. If you have any questions or concerns regarding this product, please contact our Technical Support Team by calling 01460 53535.

This booklet code N273027E - Rev. 03 - (05/2021) consists of 28 pages.

Compliance

This unit complies with the following European Directives:

- Low voltage 2014/35/EU
- Electro-magnetic compatibility 2014/30/EU
- Use restrictions of hazardous substances in electrical and electronic equipment 2011/65/EC (RoHS2)
- Waste electrical and electronic equipment 2012/19/EC (WEEE).

- Energy consumption indication on the labels of energy-related products 2010/30/EU
- ErP Directive 2009/125/EC and regulation 2012/20EC
- 2014/53/EU Radio Equipment Directive (RED)

 For declarations of conformity, certificates and other certification details please consult the website.

Symbols

The pictograms in the next chapter provide the necessary information for correct, safe use of the appliance in a rapid,

unmistakable way.

Editorial pictograms

- U** User
 - Refers to pages containing instructions or information for the user.
- I** Installer
 - Refers to pages containing instructions or information for the installer.

- S** Service
 - Refers to pages containing instructions or information for the CUSTOMER TECHNICAL ASSISTANCE SERVICE installer.

Safety pictograms

-  Warning
 - It indicates actions that require caution and a suitable preparation.

-  Prohibition
 - Refers to prohibited actions.

Contents

General table of contents

1	User manual	
1.1	Warnings	5
1.2	Management of the appliance with the touch-screen display and remote control.	5
1.3	Description of operations	6
1.4	Setting cool only or heat only modes	9
1.5	Brightness regulation	9
1.6	Touch-screen display key lock	9
1.7	Hotel function.	9
1.8	Heating operation (only for ELEC model)	9
1.9	Configuration with the nebulizer 3.0.	10
1.10	Suggestions for power saving	10
1.11	Diagnosis of problems	10
1.12	Technical specifications	12
1.13	Periodic Maintenance	13
2	INNOVA App operation	
2.1	Minimum system requirements	15
2.2	Downloading and configuring the APP.	15
2.3	App features	17
2.4	General control screen	17
2.5	Menu	17
2.6	My Products.	18
2.7	Mode.	19
2.8	Scheduling.	19
2.9	Remote access	21
2.10	Groups	23
2.11	Preferences	24
2.12	Control with several devices	25
2.13	Management on desktop	26
2.14	Troubleshooting	27

USER MANUAL



















1.1 Warnings

- ⚠ Objects or structural obstacles (furniture, curtains, plants, leaves, blinds, etc.) must not obstruct the normal air flow both from the internal and from the external grids.
- ⚠ It is strictly forbidden to place any containers on top of the appliance, especially if they contain liquid. This could trigger a short-circuit, damage the appliance and/or expose the user to the risk of electrocution.
- ⚠ Do not lean against, or worse sit on, the body of the conditioner, this would damage the appliance.
- ⚠ Do not move the horizontal air outlet flap manually. Always use the remote control to perform such operation.
- ⚠ In the event of water leaks, turn off the appliance and disconnect the electric power supply. Call the nearest service centre.
- ⚠ During heating mode, the conditioner eliminates periodically any ice formed on the external battery. In such situation, the machine keeps on working, but it does not dispense warm air to the room. This phase can last from 3 up to maximum 10 minutes.
- ⚠ The appliance must not be installed in rooms where explosive gases develop or where there are humidity and temperature conditions that exceed the maximum levels reported on the installation manual.
- ⚠ Clean the air filter regularly as described in the specific paragraph.
- ⚠ When replacing components, use only original spare parts.

1.2 Management of the appliance with the touch-screen display and remote control

- 1 Corresponding button on remote control
- 2 Corresponding button on touch-screen display

BUTTON / DISPLAY:

 Setpoint	 Heating only button (2)
 Up button	 Nocturnal well-being button
 Down button	 Control of air flow direction button
 On/off button	 Fan speed control button
 Well-being button (economic automatic mode)	 Timer mode setting button (1)
 Cooling only mode button	 Timer mode setting button (2)
 Dehumidification only mode button	 Brightness sensor
 Ventilation only mode button	 Digital thermometer; 1÷7 red bars in winter, blue bars in summer
 Heating only button (1)	 Not used

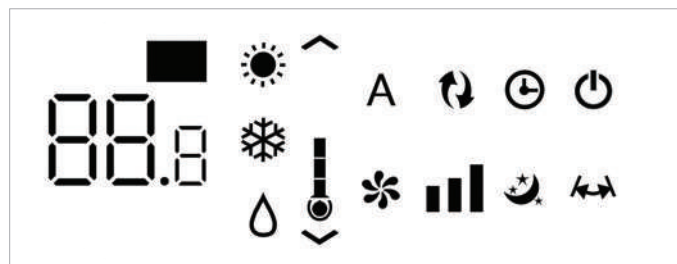

Normally, the display shows the operating status (see paragraph entitled Description of operations), as well as any alarms (see paragraph entitled Display alarms).

In addition, it is possible to select the various functions by pressing the symbols.

User Manual

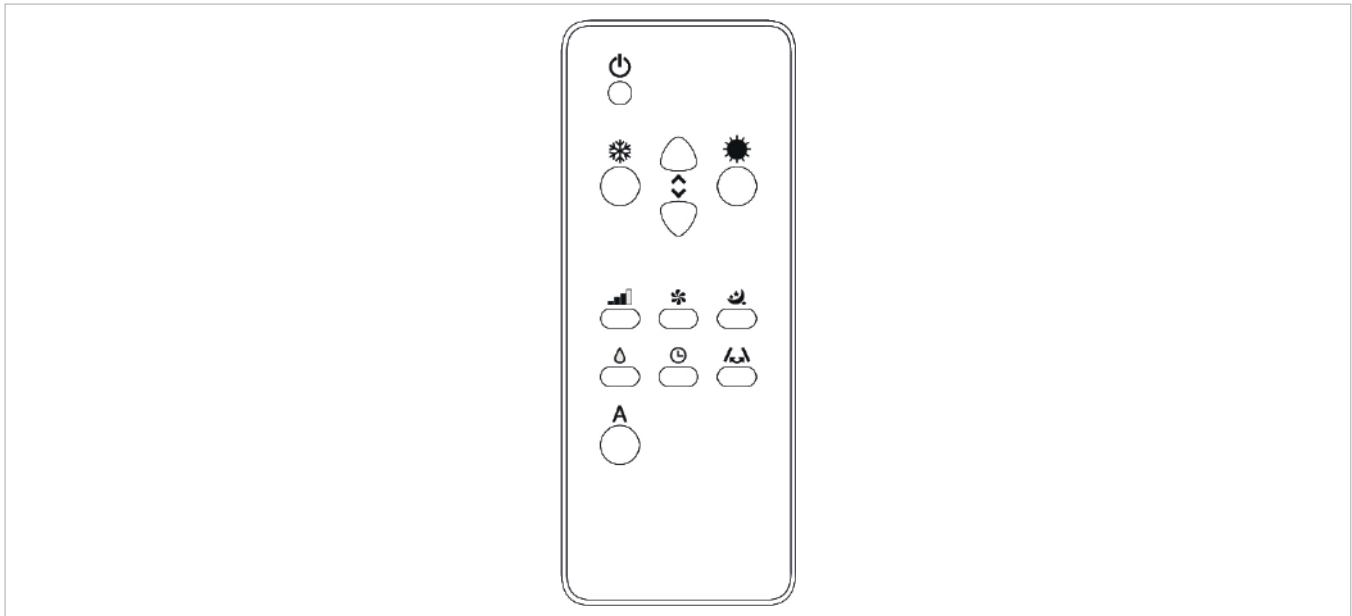

It is possible to select the various modes by pressing the buttons (see paragraph entitled Description of operations).

⚠ The remote control provided has been designed to be functional and hard-wearing, however, it must be handled cautiously.

Avoid:

- leaving it exposed to rain, pouring liquids on it or dropping it into water
- hitting it or dropping it on hard surfaces
- leaving it under the sun

- placing obstacles between the remote and the appliance while using it.

In addition:

- if there are other appliances using remote controls in the room (TV, radios, stereos, etc.), interferences may occur
- electronic or fluorescent lamps can interfere with communication between the remote and the appliance
- remove the battery if not using the remote for a long time.

Battery insertion

Only CR2012 3V dry lithium batteries must be used (supplied). Used batteries must be handed over to the specific collection areas as arranged by the Local Authorities for this type of waste.

In order to insert the batteries, open the specific cover in the bottom part of the remote. The battery must be inserted respecting polarity. Once the battery is inserted, close the cover.











1.3 Description of operations

General start-up and management







In order to manage the appliance using the remote control and the touch-screen, the main switch on the electrical power supply line must be turned on (its exact position can be indicated by the technician who installed the appliance) or the power supply plug must be connected to the system socket.

Once such operations have been performed, it is possible to manage the system by holding down the symbols on the touch-screen (for 3 seconds) or by using the remote control. In order to send commands to the internal unit, the top part of the remote must point towards the display of the internal unit. The reception of the command is confirmed by a beep and by the display. The maximum distance for the remote control to work is approximately 8 metres.

Key/Display	Operation
⚠	The keys of the remote control and of the touch screen display perform the same functions.
	When the unit is turned on, the 3 digits on the display will show the set-point.
	<ul style="list-style-type: none"> It is possible to set the set-point between 16 and 31°C, to which temperature the unit will bring the room.
	⚠ If the temperature is set too low or too high, not only it is unhealthy, but it is also an unnecessary waste of energy.

Key/Display	Operation
	<p>Switching the appliance on and off</p> <p>It is possible to switch the appliance on or off (stand-by) by pressing the specific button. The control system of the appliance is equipped with a memory, so settings will not be lost if the appliance is switched off or in the power supply is cut. This key is used to activate or deactivate the appliance for short periods of time.</p> <p>⚠ In case of long periods of inactivity, the appliance must be deactivated by disconnecting either the main switch or the plug from the socket.</p>
	<p>Well-being button (economic automatic mode)</p> <p>By choosing this mode on the appliance, it sets the best level of comfort in the room. The conditioner selects the mode automatically (cooling or heating) according to the temperature set and ventilation speed according to the temperature of the room.</p>
	<p>Cooling only mode</p> <ul style="list-style-type: none"> In this mode, the appliance dehumidifies and cools the room.
	<ul style="list-style-type: none"> It is possible to set the desired temperature between 16 and 31°C and, if this temperature is lower than the room temperature, the compressor starts up after three minutes (maximum) and the appliance starts dispensing cool air, maintaining ventilation active even if the setpoint has been reached.
	<p>Dehumidification only mode</p> <p>In this mode, the appliance dehumidifies the room. Selecting this mode is useful during mid-seasons, i.e. on days (e.g. rainy ones) when the temperature is pleasant, but excess humidity causes discomfort. This mode ignores both room temperature and ventilation speed settings. The latter is always set to a minimum. It is normal for the appliance to work intermittently.</p>
	<p>Ventilation only mode</p> <p>By selecting this function, the compressor is never activated and the appliance does not affect either room temperature or humidity. IT IS possible to choose the speed of the fan</p>
	<p>Heating only mode</p> <ul style="list-style-type: none"> In this mode, the appliance heats the room. <p>⚠ Set on heating only mode, the appliance periodically defrosts the evaporator coil, if necessary. During this phase, the conditioner does not dispense warm air, even if its internal components are on, except for the room fan.</p>
	<ul style="list-style-type: none"> It is possible to set the desired temperature between 16 and 31°C and, if such temperature is higher than the room temperature, the compressor starts up after three minutes (maximum) and the appliance starts dispensing warm air.
	<p>Nocturnal well-being button</p> <p>While the appliance is on in the selected cooling or heating mode, it is possible to choose different functions by pressing the button in order to maximise noise reduction, energy saving and nocturnal well-being regulation. In this mode, ventilation is set on minimum speed. This mode should be activated right before going to sleep.</p> <ul style="list-style-type: none"> In cooling mode, the set temperature is increased by 1°C after one hour and by another degree after two. After the second hour, the temperature is no longer changed and, after six hours, the appliance is put in stand-by. In heating mode, the set temperature is lowered by 1°C after one hour and by another degree after two. After the second hour, the temperature is no longer changed and, after six hours, the appliance is put in stand-by. <p>This function is not available for dehumidification only, ventilation only and economic automatic modes and can be excluded any time (ideally once awake) by pressing the button again. If the Timer has also been set, the appliance will turn off at the set time.</p>
	<p>Control of air flow direction</p> <p>By pressing the specific button, it is possible to either select the continuous oscillation of the mobile air outlet flap - in such case, the symbol on the display is lit - or to block it in any position.</p> <p>⚠ IMPORTANT: The mobile flap must never be moved manually. In cooling and dehumidification modes, the position of the flap is reset every 30 minutes to prevent dew from forming.</p>

User Manual

Key/Display	Operation
	<p>Fan speed control (model 8HP)</p> <p>By pressing this button several times, the speed will change according to the following sequence: Minimum, Medium, Maximum and Automatic.</p> <p>The higher the speed is set, the better the appliance will perform, but it will be less quiet. By selecting Automatic mode (shown by three speed bars moving up and down on the display), the on-board microprocessor automatically adjusts the speed, so that it stays higher the greater the difference between the temperature detected and the temperature set. The speed will always be automatically decreased as the room temperature approaches the set temperature. This is not possible in humidification only or nocturnal well-being mode where the appliance can only operate at a low speed.</p>
	<p>Setting power for models inverter 10HP and 12HP</p> <p>By pressing this key sequentially, it is possible to set the power supplied by the appliance on 5 adjustments: Minimum, Medium, Maximum, Dual Power and Automatic.</p> <p>The higher the power is set, the better the appliance will perform, but it will be less quiet.</p> <p>The Dual Power function (shown by three flashing speed bars on the display and the seven red or blue bars moving up and down of the digital thermometer), available only in heating and cooling mode, supplies a 30-minute Overboost. Then, the controller inhibits the function and switches to automatic mode.</p> <p>By selecting Automatic mode (shown by three speed bars moving up and down on the display), the on-board microprocessor automatically adjusts the speed, so that it stays higher the greater the difference between the temperature detected and the temperature set. This is not possible in humidification only or nocturnal well-being mode where the appliance can only operate at a low speed.</p>
	<p>Setting the Timer function</p> <ul style="list-style-type: none"> The appliance allows the user to program when to turn it on and off, as required.
	<ul style="list-style-type: none"> While the conditioner is running, it is possible to schedule when it turns off by pressing the Timer button, followed by the number of hours (from 1 to 24), after which the unit will be put in stand-by.
	<ul style="list-style-type: none"> When the air conditioning unit is off, it is possible to schedule when it turns on by pressing the Timer button, followed by the number of hours (from 1 to 24) after which the unit will start.
	<ul style="list-style-type: none"> Then, press the confirm button.
	<p>Touch-screen display key lock</p> <ul style="list-style-type: none"> The key lock is activated by keeping the Timer symbol on the touch-screen display pressed for three seconds. The user cannot perform any actions. The stand-by symbol flashes every second. To deactivate the lock, keep the Timer symbol on the touch screen pressed for three seconds once again.
	<p> The lock remains active in the case of a power failure and also if the remote control is used!</p>

1.4 Setting cool only or heat only modes

It is possible to deactivate the heating or the cooling modes following a simple procedure. Keep the A key on the touch-screen display pressed for 5 seconds until HC (heating and cooling) appears on the display.

Press the A key for 1 second to switch to the CO (cooling only) mode.

Press the A key again to switch back to HO (heating only) mode.

Wait for 3 seconds without touching anything to memorise the setting and return to normal operations.

1.5 Brightness regulation

The display brightness sensor can be disabled (leaving the maximum brightness at all times) by pressing and holding

the night button () for 10 seconds. "ds" (disabled) or "En" (enabled) will appear on the display.

1.6 Touch-screen display key lock

The key lock is activated by keeping the Timer  symbol on the touch-screen display pressed for three seconds. The user cannot perform any actions. The stand-by symbol flashes every second.

To deactivate the lock, keep the Timer symbol on the touch screen pressed for three seconds once again.

The lock remains active also for the next operations performed via remote control and in the event of a power failure.

1.7 Hotel function

Press and hold the air exchange key () for 10 seconds to enable the function ("En" displayed); the dehumidification and Auto functions are disabled (leaving active only

ventilation, heating and cooling) and the settable set range is reduced from 22 to 28 in cooling mode and from 16 to 24 in heating mode).

1.8 Heating operation (only for ELEC model)

The 12HP DC inverter ELEC has an additional electric element which provides heat when the weather conditions outside are bad. The heat power of the resistor is equal to 900 W, so when the device software switches the 2.0 unit on, it will provide the combined thermal power produced by the heat pump and the thermal power of the electric element.

If you need to operate the appliance in quiet mode, it can be activated with "element only", without the compressor, simply by setting the night-time mode by pressing the button .

In this case, the element comes on if:

- the 2.0 unit is working with the heat pump (heating mode);
- the room temperature (measured by the internal probe) is one degree less than the configured setpoint;
- the room temperature is ≤ 27 °C;
- there are no alarms or failures related to the ventilation, room temperature probe and temperature coil.

The ventilation speed in this mode is fixed at 900 rpm.

If night-time operation is not selected, the element will switch on, together with the compressor, if:

- the 2.0 unit is working with the heat pump (heating mode);
- the room temperature is ≤ 24 °C;
- the room temperature is 2°C lower than the setpoint;
- the internal coil temperature is ≤ 44 °C;
- the ventilation is switched on and stable;
- there are no alarms or failures related to the ventilation, room temperature probe and temperature coil. In normal operation, with the heating switched on, the element will deactivate if:
- the coil temperature of the internal exchanger is ≤ 47 °C;
- the room temperature is greater than the setpoint;
- the room temperature is at 25 °C;
- the ventilation stops or the fan is faulty;
- the compressor discharge temperature increases abnormally;
- the compressor operating frequency increases abnormally;

N.B. For the ELEC versions with resistor, disconnecting voltage from the device abruptly is prohibited in order to prevent internal overheating! Use the CP contact that places the device in standby and guarantees correct post-ventilation.

Also, remember never to cover the intake grille and output vent in any way whatsoever!

User Manual



1.9 Configuration with the nebulizer 3.0

Season change procedure

Note: When installing the nebulizer 3.0 it's very important to follow the indicated procedure to avoid a systematic alarm and the possible failure of the nebulizer.

This procedure, enabled through the display of the air conditioner ..2.0, modifies the default settings of the drain pan of the appliance by disabling its automatic closure during the summer season. This procedure is used to avoid that during the summer season, with the opening of the drain valve of the drain pan, the condensate itself is poured all in the 3.0 nebulizer installed under the appliance.

To activate this function:

- Press the cooling mode key  on the display of the ..2.0 for 15 sec.
- The symbol "En" will appear
- Press again for 15 sec. the key 
- The symbol "ds" will appear
- Let the display go back to the main screen

The condensate drain will always remain open in both seasons, guaranteeing a regular flow of condensation.

1.10 Suggestions for power saving

- Always keep the filters clean (see maintenance and cleaning chapter).
- Keep the doors and windows of the rooms to be air conditioned closed
- Do not let direct sunlight to enter the room (use curtains or lower the blinds or close the shutters)

- Do not block the air flow paths (input and output) of the unit; this, as well as causing a non-optimal performance of the unit, will jeopardise the correct operation of the same and may cause irreparable damage to the units.

1.11 Diagnosis of problems

For the User it is very important to distinguish any inconveniences or abnormal operation of the unit compared to its normal operation. Also, the most common problems can be easily solved by means of simple operations performed by the User (See paragraph: Troubleshooting), while for some alarms signalled on the

display, it is necessary to contact Customer Service..

-  We also remind you that any attempt to repair the unit on part of unauthorised technicians will void the warranty immediately.

Operating aspects that should not be interpreted as problems

- The compressor will not restart before a certain time has passed (about three minutes from the previous stop). It is not possible to stop and restart the compressor without waiting at least three minutes. This is provided for in the operating logic of the unit, so as to protect the compressor from frequent activations.

- During operation in heating mode, the warm air is delivered a few minutes after the activation of the compressor. If the fan started at the same time as the compressor, in the first minutes of operation the air delivered would be too cold (which may disturb the occupants of the room) since the unit is not yet ready.

Open CP contact

If the presence contact is not closed, the appliance will not start and the **CP** alarm appears on the display.

Evacuation of condensate water in the event of an emergency

Should any anomaly occur in the condensation water system, the maximum level float blocks the conditioner and the **OF** code appears on the display.

During cooling and dehumidification, electronics keeps the water distribution system active with the battery - together with the fan - to disperse excess water in the container. If the problem persists, please contact the assistance service.

During heating, condensation should drain freely through the specific pipe. In the event of an alarm, check that the condensation pipe is not bent or obstructed, thus preventing the water from flowing out.

Note: At the end of the summer season empty the residual condensation by opening the cap of the condensation drainage pipe.

Using the unit if the remote control is not available

If the remote control has been lost, the batteries are exhausted or it no longer works, the unit can be operated by using the keys on the touch screen display on the machine.

Troubleshooting

In the even of a malfunction, please refer to the following table. If, after performing the suggested checks, the problem is not solved, please contact the authorised technical assistance.

Fault	Possible causes	Solution
The appliance doesn't switch on	No power supply	Check there is power supply (by turning a light on, for example). Check that the thermal-magnetic circuit breaker used exclusively to protect the appliance has not been tripped (if it has, reset it). If the problem repeats immediately, please call the Service Centre and avoid trying to make the appliance work.
	Remote control batteries have run out	Check that the appliance can be turned on using the touch-screen display and substitute the batteries.
The appliance does not cool/heat adequately.	The temperature set is too high or too low.	Check and adjust the temperature, if necessary.
	The air filter is clogged	Check the air filter and clean it if necessary
	Check that there are no other obstacles to the air flow both inside and outside.	Remove anything that might block the air flow.
	The heating and cooling load has increased (for example, a door or a window has been left open or an appliance has been installed in the room which generates a lot of heat).	Try to reduce the heating and cooling load of the room following instructions below: <ul style="list-style-type: none"> Cover large windows exposed to sunlight with curtains or with external maskings (blinds, porches, reflecting films, etc.); The air conditioned room must remain closed for as long as possible; Avoid turning on halogen lamps or other high energy consumption appliances such as small ovens, steam irons, hot plates etc.).

Display alarms

An alarm code appears on the display in the event of faults. Some of the functions, however, remain active (see FUNCTIONING column).

Alarm	Cause	Operation
E1	Faulty room temperature RT sensor	It is still possible to activate Cooling, Dehumidification and Heating modes. It only monitors the antifreeze function of the internal coil.
E2	Faulty internal coil IPT sensor	It is still possible to activate Cooling, Dehumidification and Heating modes.
E3	Faulty outside temperature OT sensor	It is still possible to activate Cooling, Dehumidification and Heating modes.
E4	Faulty external coil OPT sensor	It is still possible to activate Cooling, Dehumidification and Heating modes. Defrosting is performed at fixed times.
E5	Faulty internal fan motor	None of the modes can be activated.
E6	Faulty external fan motor	None of the modes can be activated.
E7	Lack of communication with the display *	None of the modes can be activated.
E8	Compressor discharge probe failure	None of the modes can be activated.
CP	Open CP contact	The appliance only works if the contact is closed. Check that the clamps are connected.
OF	Maximum level float intervention	During cooling and dehumidification, electronics switches the compressor off and keeps the water distribution system active with the battery - together with the fan - to disperse excess water. During heating, condensation should drain freely through the specific pipe. In the event of an alarm, check that the condensation pipe is not bent or obstructed, thus preventing the water from flowing out.

* for models 10 and 12 HP DC Inverter: lack of communication between the main, power, driver or display boards

The only way to solve the problem is to disconnect and reconnect the appliance. If the alarm still appears, please contact the authorised technical assistance.

User Manual

1.12 Technical specifications

Please read data plate to obtain the technical data listed below.

- Serial number to enter in the App
- Power supply voltage
- Maximum absorbed power
- Maximum absorbed current
- Amount of refrigerant gas
- Casing protection level

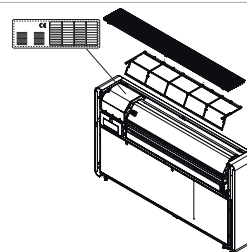

	U.O.M.	8 HP	9 HP MINI DC Inverter	10 HP DC Inverter	12 HP DC Inverter	12 HP ELEC DC Inverter
Technical specifications						
Cooling power (1)	kW	1,65	1.73	2,04	2,35	2,35
Power in max cooling mod. Dual Power	kW	-	2.35	2,64	3,10	3,10
Power in min cooling mod.	kW	-	0.70	0,83	0,92	0,92
Heating power (2)	kW	1,70	1.71	2,10	2,36	2,36
Additional power electrical resistance	kW	-	-	-	-	0,90
Power in max heating mod. Dual Power	kW	-	2.4	2,64	3,05	3,05
Power in min heating mod.	kW	-	0.75	0,71	0,79	0,79
Power absorbed when cooling (1)	W	580	0.57	630	730	730
Power absorbed when heating (2)	W	545	0.54	638	720	720
Dehumidification capacity	L/h	0,7	0.7	0,8	0,9	0,9
Power supply voltage	V-F-Hz	230-1-50	230-1-50	230-1-50	230-1-50	230-1-50
EER		2,84	3.01	3,24	3,22	3,22
COP		3,12	3.15	3,29	3,28	3,28
Energy efficiency class when cooling		A	A	A+	A+	A+
Energy efficiency class when heating		A	A	A	A	A
Internal-external ventilation speed	No.	3	3	3	3	3
Internal/external air flow at max speed	m ³ /h	360/430	360/430	380/460	400/480	400 (8)
Internal/external air flow at medium speed	m ³ /h	300/360	300/360	310/380	320/390	320 (8)
Internal/external air flow at min speed	m ³ /h	240/320	240/320	260/330	270/340	270 (8)
Dimensions (WxHxD)	mm	1010x549x165	810x549x165	1010x549x165	1010x549x165	1010x549x165
Weight	kg	41	38	41	41	41
Sound pressure level (min-max) (4)	dB(A)	38/29	39/27	39/26	41/27	41/27
Unit sound power level inside (min-max) (5)	dB(A)	44/57	44/57	44/57	45/58	45/58
Wall holes diameter	mm	162	162	162	162	162
Wall holes distance	mm	293	210	293	293	293
Refrigerant gas		R410A	R290	R410A	R410A	R410A

* with Dual Power function activated during heating

Reference conditions

		Room T	External T
(1)	Cooling mode tests (EN 14511)	DB 27°C - WB 19°C	DB 35°C - WB 24°C
(2)	Heating mode tests (EN 14511)	DB 20°C - WB 15°C	DB 7°C - WB 6°C
(3)	Heating mode tests	DB 20°C - WB 15°C	DB -7°C - WB -8°C
(4)	Internal side sound pressure measured in semi-anechoic chamber at a distance of 2 m.		
(5)	Internal side sound pressure measured in accordance with regulation EN 12012		

Operating limits

	Internal ambient temp.	External ambient temp.
Maximum operating temperature in cooling mode	DB 35°C - WB 24°C	DB 43°C - WB 32°C
Minimum operating temperature in cooling mode	DB 18°C	DB -5°C
Maximum operating temperatures in heating mode	DB 27°C	DB 24°C - WB 18°C
Minimum operating temperatures in heating mode	DB 5°C	DB -10°C

Red Compliance Statement

Compliance with 2014/53/EU Radio Equipment Directive (RED).

In accordance with Article 10.8(a) and 10.8(b) of the RED, the following table provides information on the frequency bands used

Frequency Range (MHz)	Max. Transmit Power (dBm)
2400-2472	< 20

Hereby, the company declares that the device is in compliance with Directive 2014/53/EU.

 For declarations of conformity, certificates and other certification details please consult the website.

Safety

This equipment is designed with the utmost care for the safety of those who install and use it. However, special attention must be paid to the dangers of electric shock and static electricity when working with electrical equipment.

and the maximum RF transmit power of the product for sale in the EU:

This equipment should be installed and operated with a minimum distance of 20 centimeters between the radiator and your body.

All guidelines of this and of the computer manufacture must therefore be allowed at all times to ensure the safe use of the equipment.

User Manual

1.13 Periodic Maintenance

The air conditioner you have bought has been designed to keep maintenance operations to a minimum, in fact, they

only include the following cleaning operations:

External cleaning

- ⚠ Disconnect the unit from the power supply before each cleaning and maintenance intervention by setting the main power supply switch to off.
- ⚠ Wait for the components to cool down in order to avoid any burns.

- ⚠ Do not use abrasive sponges or abrasive or corrosive detergents as you might damage the painted surfaces.

When necessary, clean the external surfaces with a soft damp cloth.

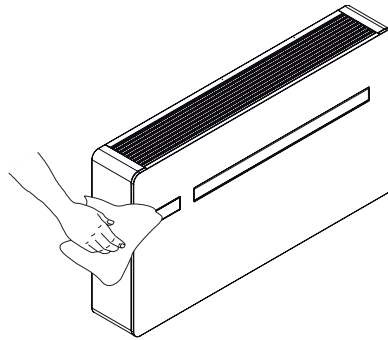

Cleaning the filters

The air conditioner you have bought has been designed to keep maintenance operations to a minimum, in fact, they only include the following cleaning operations:

- Clean the air filter after a period of continuous use and according to the concentration of impurities in the air, or when you wish to start-up the appliance after a period of inactivity.
The filter is located in the top part of the appliance.

To extract the filters:

- open the grid and remove it;
- extract the filters by lifting them;
- remove the dust from the filter with a vacuum cleaner or by washing it in running water without using detergents or solvents and leave to dry;
- put the filters back on top of the batteries, taking care to position them correctly;
- put the grid back.

- ⚠ After filter cleaning check if the panel is properly mounted.

- ⊘ It is forbidden to use the device without its mesh filter.

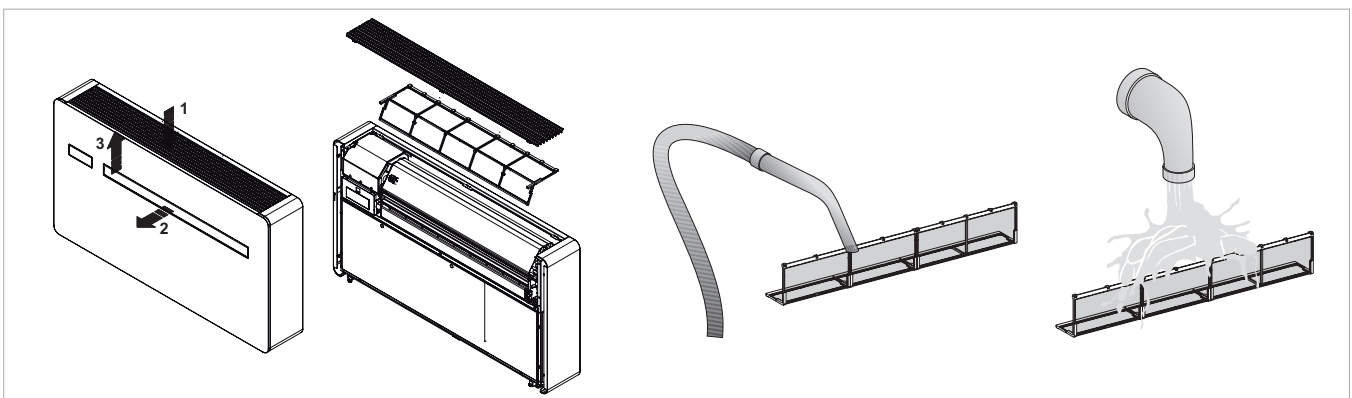



2.1 Minimum system requirements

The INNOVA TwoPointZero App lets you manage the main parameters of your air conditioner using a smartphone and tablet or with a specific desktop version conveniently from home or when you are out. Using our App is very simple. Just switch on the air conditioner display, set up the connection with your smartphone and begin managing the air conditioner directly from your device.

Follow the step by step guide all the way to the end.

To download and install the app, there are some operating system version requirements for your smartphone:

- for Android smartphones, the minimum version is 4.1.1
- for Apple smartphones, the operating system must be IOS 8.0 or higher.

2.2 Downloading and configuring the APP

1. From your smartphone, connect to the Apple Store or Google Play.
2. Search for InnovApp TwoPointZero
3. Download the App onto your smartphone, following the installation wizard to install it.
4. Open the App

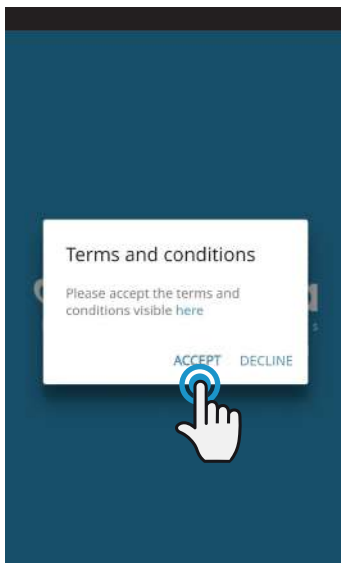

Figure 2-1

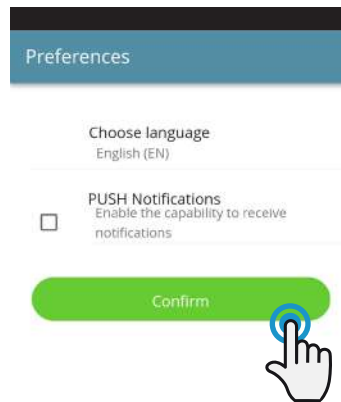

Figure 2-2



Figure 2-3

At the first launch, a pop-up appears for acceptance or refusal of the terms and conditions of use, which can be consulted by tapping on the word “here”, therefore accessing the INNOVA website. (Figure 2-1)

Tap “Let’s get started” to begin using InnovApp TwoPointZero.

Select the language and the PUSH notification management method.

Tick the “PUSH notifications” preference to receive alarms connected to the air conditioner’s operation on your smartphone even when the App is closed. (Figure 2-2)

Note: These settings can also be changed later by selecting the “Preferences” menu item.

InnovApp Operation



Figure 2-4

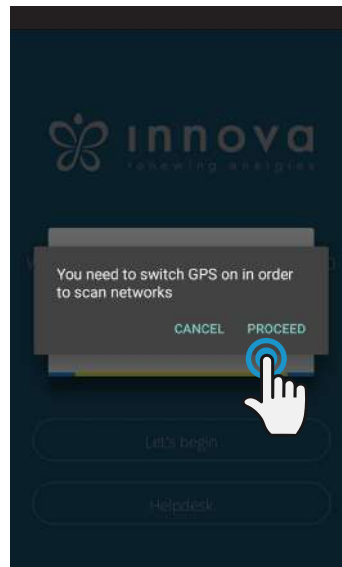

Figure 2-5

After switching on the display of your air conditioner, go to your telephone's WiFi settings:

1. ensure that you have activated WiFi
1. check the available WiFi connections
1. find the Innova 2.0 network
1. connect to it.

Note: with Android devices, this procedure is automatic. With iOS devices, you must enter the WiFi settings of your device and select the "Innova2.0" network.

Note: If there are several air conditioners to configure, switch on one at a time in order to prevent errors.

Note: If the App asks you to be connected to the position, to accept for facilitating the search of the conditioner. (Figure 2-5)

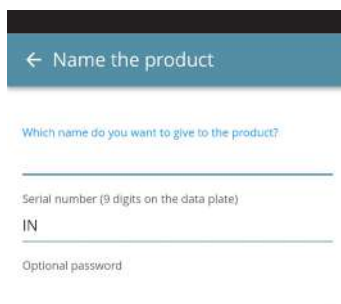

Figure 2-6

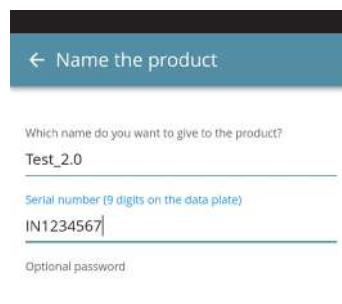

Figure 2-7

The product screen appears (Figure 2-6) where you can assign a name and indicate the unit's serial number, made up of 9 alphanumeric characters on the air conditioner's data plate (see section 1.11 on page 11).

A password can be set for the Innova 2.0 network in order to protect against management of your product by unauthorised users.

Note: For iOS devices, after entering the name of the product, the WiFi network name also changes automatically.

For iOS devices, once the name has been edited, you must therefore go back to your telephone's WiFi settings and connect to the renamed network "Innova2.0" followed by _ and the name that you have just established, for example "Innova2.0_Test_2.0)". (Figure 2-8)

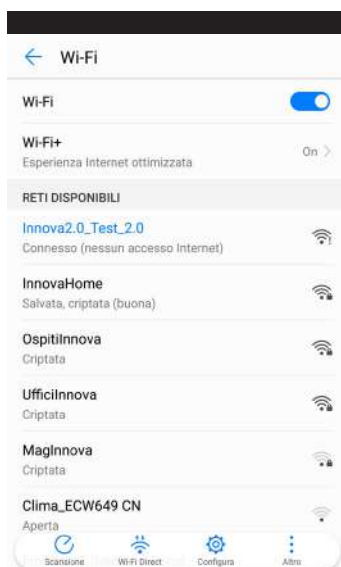

Figure 2-8



Figure 2-9

Note: The device name can also be changed later by accessing the menu item "My Products" and tapping on the second icon (pencil symbol).

When one of the configured products is selected, the general air conditioner control screen appears, through which it can be controlled and managed. (Figure 2-9)

Note: From this moment on, your smartphone becomes the remote control that you use to control the air conditioner over the local network, but not over the Internet.

In order to do this, you must complete another step: connect to your home WiFi, accessing your smartphone's settings and then select the "Remote Control" menu item.

2.3 App features

2.4 General control screen

GENERAL CONTROL SCREEN of the air conditioner

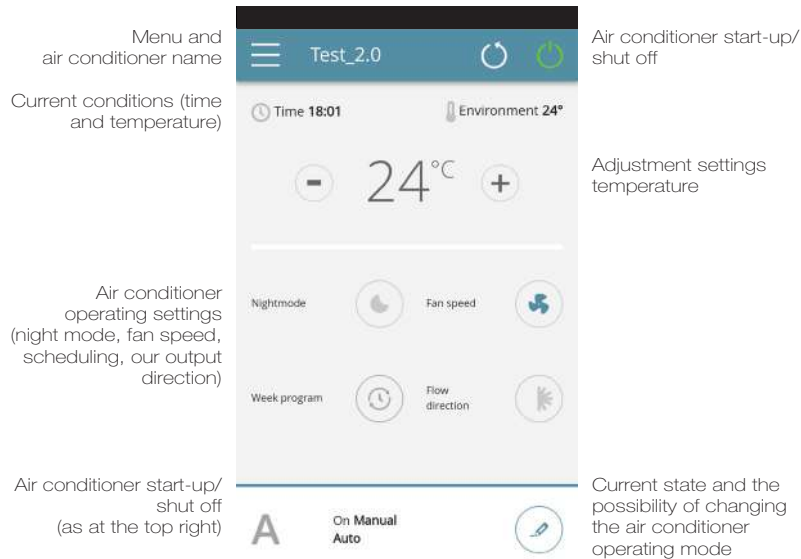

Figure 2-10

2.5 Menu

MENU

menu items

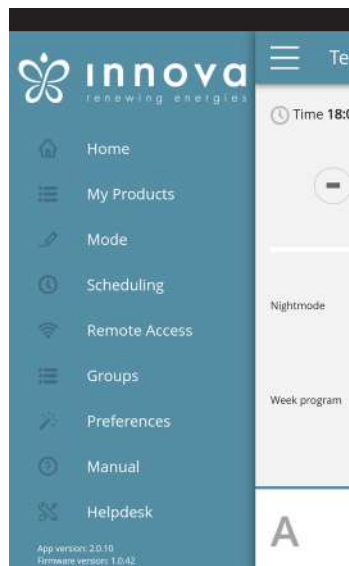

Figure 2-11

HOME
general control screen
(Figure 2-10)

MY PRODUCTS
list of the air conditioners and groups of air conditioners configured in the App

MODE
list of possible air conditioner management modes (manual, automatic, night, scheduled,...)

SCHEDULING
section dedicated to the weekly scheduling of the air conditioner.
Note: this is possible only if remote control has been configured

REMOTE ACCESS
visible only when the device is configured in standalone mode and used to move to the cloud

ADVANCED
visible only when the device is configured in cloud mode and allows DHCP / IP configuration of the network

GROUPS
list of groups of several air conditioners (e.g. 1st floor, 2nd floor,...).

PREFERENCES
language and PUSH notifications

MANUAL
link to the INNOVA website where you can find the necessary documentation

www.innovaenergie.com/en/documents-products-airconditioners-innova/manuals/

HELPDESK
to ask for support

InnovApp Operation

2.6 My Products

MY PRODUCTS

list of the air conditioners and groups configured in the App



Figure 2-12



Figure 2-13

By selecting the "My Products" item, you can see the air conditioners on the network. They can be edited and/or scheduled as desired.

New devices can be added, searching for, installing and configuring them tapping on the + symbol in the top right corner and/or at the bottom right.

This will open the screen as illustrated in Figure 2-13.

When you select one of the configured products, appears the general air condition control screen, through which it can be controlled and managed.

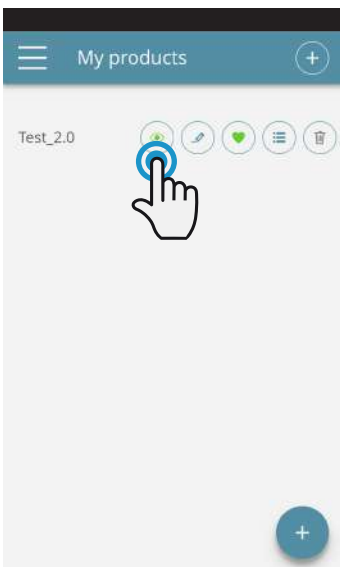

Figure 2-14

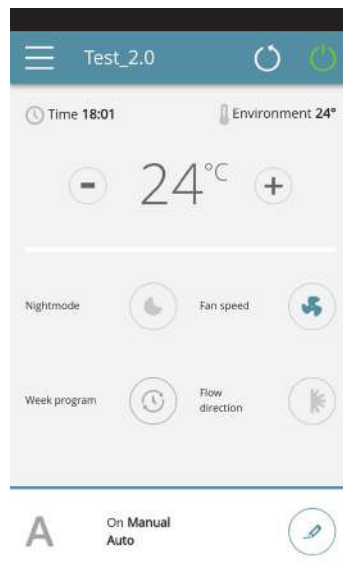

Figure 2-15



View the general control screen of the device (if configured as standalone it will automatically connect to your network)



Change the device name (only if connected to the WiFi network of the same)



Set your device as a favorite (the default device will be displayed when the app starts)



List of devices



Delete the device from the list of configured devices

2.7 Mode

MODE

list of possible air conditioner management modes

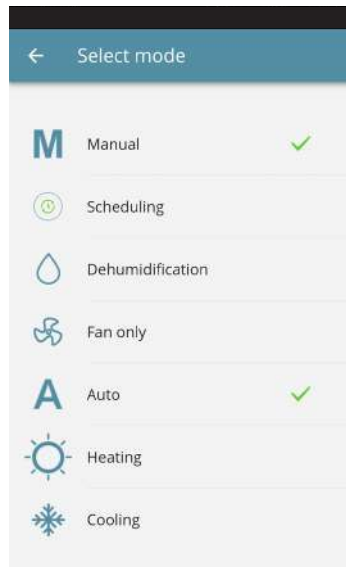

Figure 2-16

The air conditioner operating mode can be changed in several ways:

- selecting "Mode" in the general menu
- clicking on the change button at the bottom right of the air conditioner general screen (see section 2.4 on page 15).

This provides access to the screen illustrated in Figure 2-16.

2.8 Scheduling

SCHEDULING

section dedicated to the weekly scheduling of the air conditioner

Note: this option is possible only if remote control has been configured (see section 2.9 on page 19 to enable remote control).

By selecting the "Scheduling" item, you access the air conditioner calendar scheduling feature. (Figure 2-17).

By clicking "edit" on a day of the week, you can add and define one or more start-up and shut-down periods for the air conditioner during that day, clicking on the "+" symbol. (Figure 2-18).

Note: Schedule several start-up/shut-down periods with a minimum duration of half an hour on the same day.

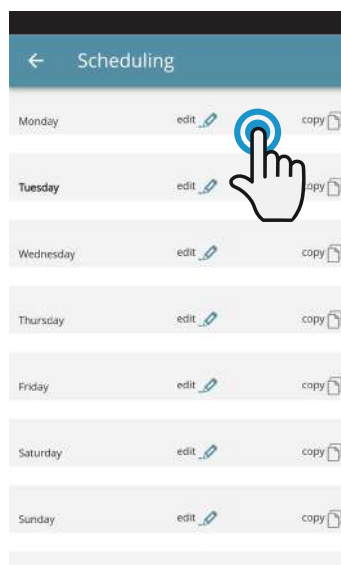

Figure 2-17

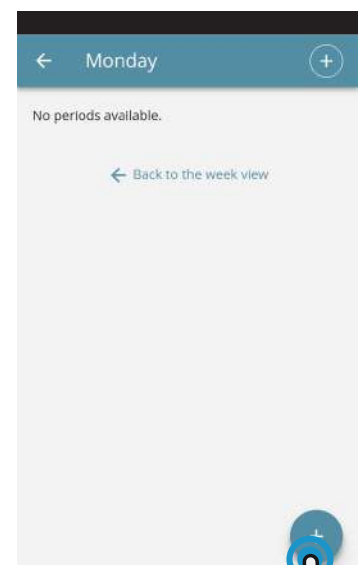

Figure 2-18

InnovApp Operation

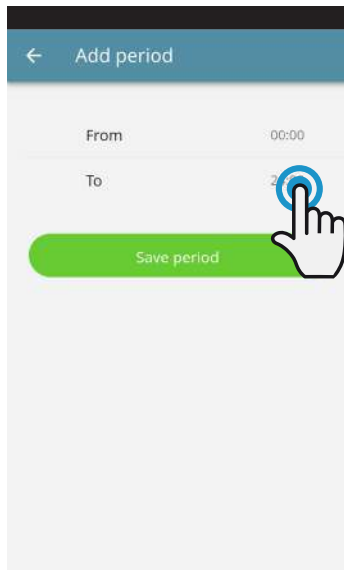

Figure 2-19

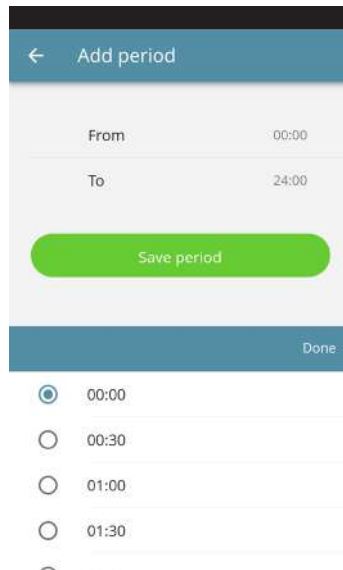

Figure 2-20



Figure 2-21

To change the switching on or off period, click on one of the two times (Figure 2-19).

Once scheduling of a day has been confirmed, you will be returned to the screen with the list of the days of the week. (Figure 2-22)

If you want to apply the same schedule that you have just confirmed for other days, simply click "copy" and select the days where you want to apply this schedule (as illustrated in the sequence of example figures shown below).



Figure 2-22

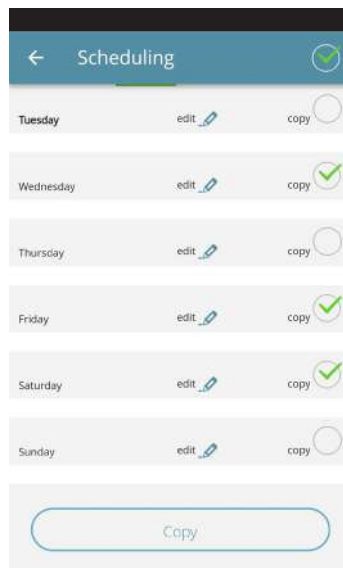

Figure 2-23



Figure 2-24

InnovApp Operation

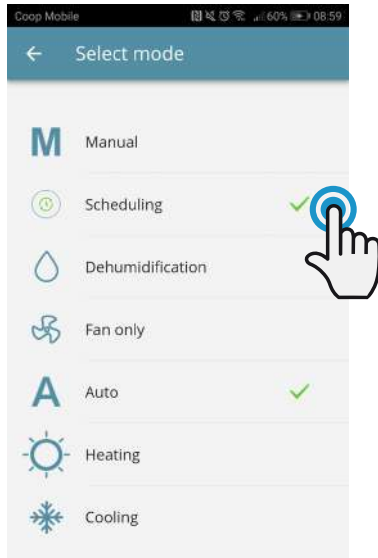

Figure 2-25

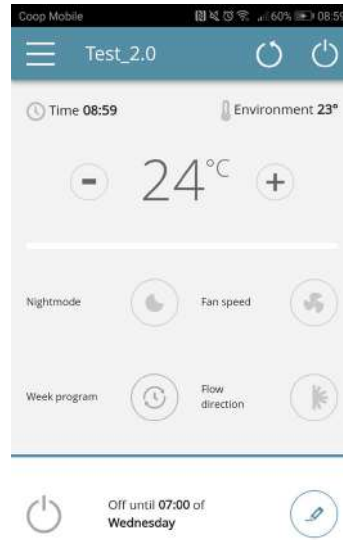

Figure 2-26

After completing scheduling, select the "Mode" item in the general menu, then "Programming". This activates the weekly program you just created.

Returning to the air conditioner's main screen (Figure 2-26), on the lower part, there are the indication of the scheduling.

If you was in the scheduled shut-down time, the time of the first air conditioner restart will be showed in the lower part.

To deactivate scheduling and return to manual mode:

- select "Mode" in the general menu and then "Manual".

- clicking on the edit icon at the bottom right of the air conditioner general screen.

Note: If the settings are changed on the air conditioner display, scheduling is disabled and manual mode is resumed.

If the air conditioner is in a place that is open to the public, where it cannot be monitored, the display screen lock can be enabled in order to prevent unauthorised people from changing the settings.

Simply press and hold the Timer symbol  on the air conditioner display for 10".

To go back to editing the air conditioner settings from the display, press the timer icon again for 10".

2.9 Remote access

REMOTE ACCESS

manage your air conditioner even away from home

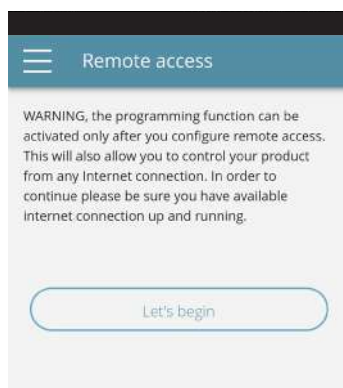

Figure 2-27

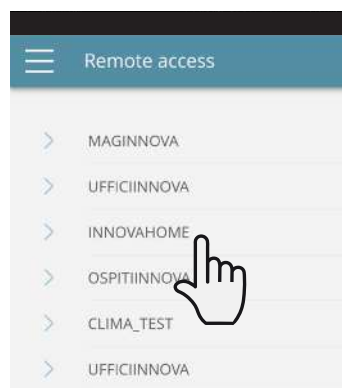

Figure 2-28

Once you have selected the menu item "Remote Access", a list of the available WiFi connections will appear.

Note: the air conditioner can connect only with 2.4GHz networks.

Select the preferred network for Internet access.

Then enter the WiFi network password and confirm it.

Note: the password can contain only alphanumeric characters from "A" to "Z" (uppercase and lowercase), from "0" to "9", "-", "_", ".", ":", ";". Special characters are not permitted.

InnovApp Operation

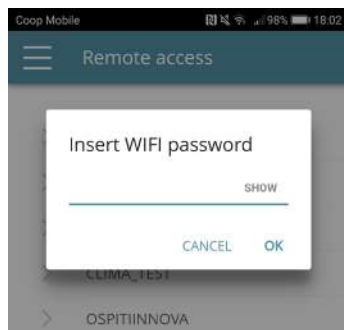

Figure 2-29

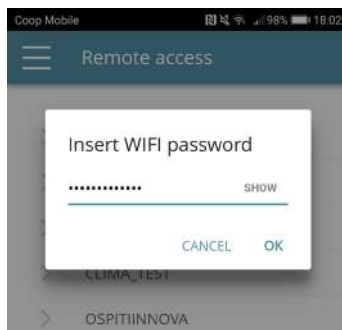

Figure 2-30

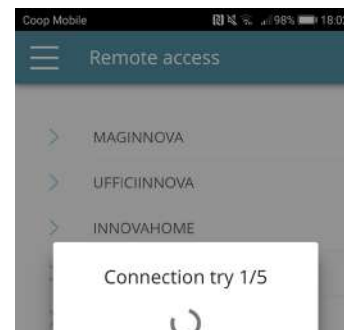

Figure 2-31

The App connects the air conditioner to the domestic network and the main screen to manage the appliance will appear again on the smartphone/tablet. At this point, the smartphone/tablet is connected to the selected network.

From this moment, your 2.0 air conditioner is connected to a server over the Internet and can be managed from anywhere in the world over your telephone's WiFi or data connection.

Note: In the event that the procedure is not successful, the smartphone/tablet will automatically reconnect to the local network of the 2.0. Therefore, repeat the procedure, rechecking the password entered and the name of the network.

Note: When the device is displayed in the cloud it may happen that the display of "Temp" is the name for the device. In this specific case the device failed to restart, the communication works correctly but the name is incorrect. To solve, it is necessary to rewind the air conditioner (removing and returning power).

Wifi network features

- working internet connection
- static public IPs are not required
- no incoming configurations are required on the ROUTER (NAT or other specific rules) - working dns service
- functioning DHCP service or alternatively the following information:
 - local ip address to be assigned to the subnet mask card
 - gateway
 - dns

- if the router or other entities in the customer's network have ACLs at the MAC-address level, the MAC-address of the card must be enabled if the client wants to control some features locally (noe change, advanced settings change, pc control) WIFI network must allow communication between devices connected to the same wifi (= Wifi Isolation must not be enabled)

Technical requirements for the proper functioning of the cloud connection TCP port 80, 443, 19009, 18321, 18009 output

2.10 Groups

GROUPS

list of groups of several air conditioners

If you have several air conditioners, you can combine them in groups to simplify scheduling and management of them. (For example, the air conditioners in a hotel could be grouped by floor).

First of all, select "Groups" in the menu and create a new group by clicking on "+". (Figure 2-32)

Then give a "Title" to the group and save using the icon at the top right. (Figures 2-33 e 2-34)

The group has been created but it has still not been associated with any air conditioners.

Returning to the "Groups" screen, the new group will appear and it can be edited or deleted using the adjacent icons.

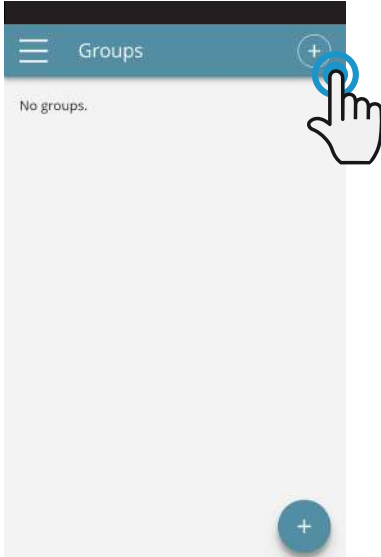
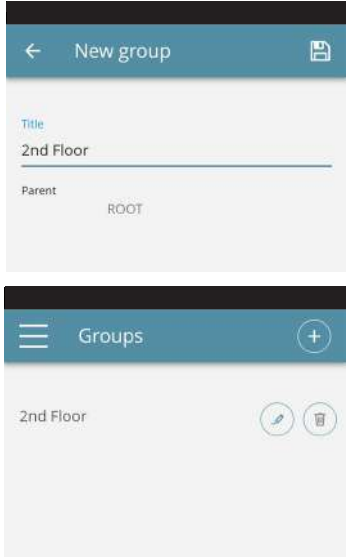

Figure 2-32



Figures 2-33 e 2-34

To associate an air conditioner to a group, select "My Devices" item from the menu. The section contains the list of all the configured air conditioners and groups.

Click on the eye beside the group name and then on the "+" symbol and select the air conditioners to associate. Lastly, save using the icon at the top right.

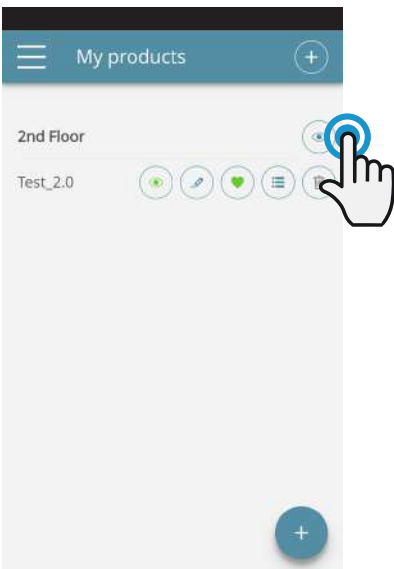

Figure 2-35

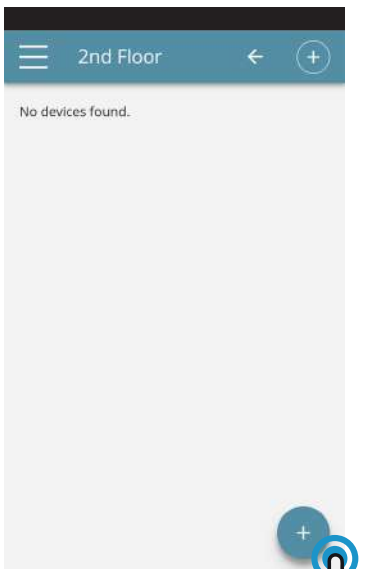

Figure 2-36



Figure 2-37

InnovApp Operation

You can also associate an air conditioner with the group through the air conditioner itself.

Select the penultimate icon on the row of the air conditioner (icon list with three rows) and click "Assign groups" (Figure 2-39). Assign the air conditioner to one of the groups shown on the list.

When, on the other hand, you click "Sent settings", the settings of that air conditioner are applied to the group that will be selected.



Figure 2-38

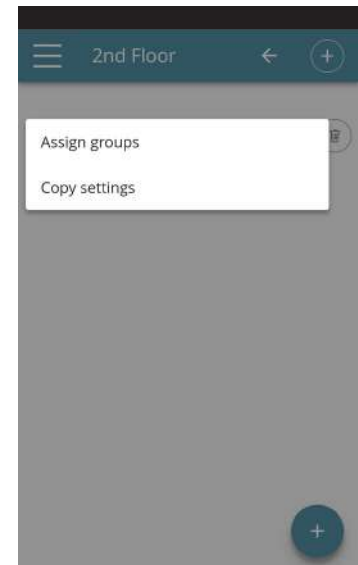

Figure 2-39

2.11 Preferences

PREFERENCES

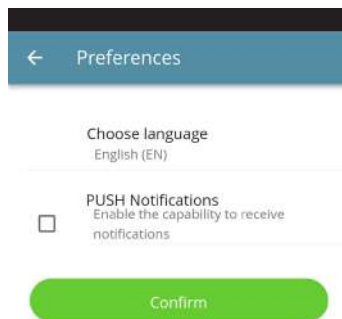

Figure 2-40

In the "Preferences" section which can be selected on the menu, the App language and the PUSH notification settings can be changed.

To receive notifications on the air conditioner's operation directly on your smartphone even when you are not using the App, tick the "PUSH Notifications" option.

2.12 Control with several devices

CONTROL WITH SEVERAL DEVICES

The same air conditioner can be managed with several devices (smartphone/tablet/PC).

After configuration with the first device, the machine can be controlled with another smartphone/tablet following the procedure described below.

First of all, you must connect to the Wi-Fi network where the 2.0 you want to control is also connected.

Install the “InnovApp TwoPointZero” app on the new smartphone/tablet and proceed as illustrated in figures 2-1, 2-2 and 2-3 on page 13.

At this point, the telephone alerts that you are not connected to the right WiFi network and to connect to the “Innova2.0”: ignore the warning, clicking on the “**devices**” button right below the loading bar (Figura 2-41).

If you are connected to the WiFi network where your 2.0 is also connected, the telephone automatically scans all the “2.0” units connected to the network (Figura 2-42).

Once the device has been found, the general control screen opens automatically, from which you can control the air conditioner with the second telephone/tablet as well.

Note: If the search does not automatically find the air conditioner, press “+”.



Figure 2-41



Figure 2-42

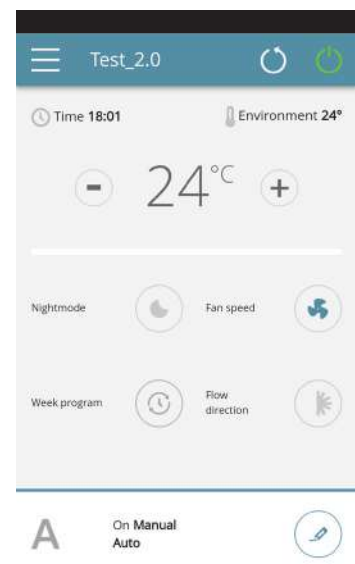





Figure 2-43

ON, OFF and RESET OF THE WIFI NETWORK

To activate the WiFi network:

- Press and hold in the button  on the air conditioner display for 10 seconds. When the word “**On**” appears on the display, release the button.
- If you do not touch anything for another 10", the 2.0 WiFi is active and remains visible and usable with the last configured name.

To reset the air conditioner and return its WiFi network to the original configuration (named “Innova2.0”):

- Press and hold in the button  on the air conditioner display for 10 seconds. The message “On ” appears on the display.
- Press the button  again. The abbreviation “**rSt**” will appear. Wait 10" so that the operation will complete successfully.

- At this point, new WiFi configuration of the 2.0 is required, starting from the indications in Figure 2-4.

To turn off the WiFi network:

- Press and hold in the button  on the air conditioner display for 10 seconds. The message “On ” appears on the display.
- Press the button  until the text “OFF ” appears.
- The WiFi transmitter will therefore be off and no longer visible from smartphone/tablet.

InnovApp Operation

2.13 Management on desktop

You can also manage the air conditioner from your computer, configuring a specific desktop version of the App.

- Access the “Software” page of the INNOVA website:

www.innovaenergie.com > documents > software

MAC

- Download the zipped folder “**TwoPointZero InnovAPP desktop version - MAC**” and open it;
- double click on the file **run.sh** to open a command window:
 - type **cd**
 - drag the folder “**TwoPointZero InnovAPP desktop version - MAC**” into the command window (Figure 2-10) and press Enter
 - type **sh run.sh** and press Enter (Figure 2-11)
- The browser window will open with the first screen of the App for the desktop version. (Figure 2-12)
- You can begin with the configuration as explained in section 2.2 for the mobile version.

WINDOWS

- Download the zipped folder “**TwoPointZero InnovAPP desktop version - WINDOWS**” and open it;
- double click on the file **run.bat** and the browser screen will open (Figure 2-12) and one of CMD.

Note:

Minimum requirements:

- Chrome: 67
 - Firefox: 60
 - Opéra: 53
 - Safari: not supported
 - IE: not supported
 - Edge: not supported
- (Safari, IE et Edge do not partially or totally support RTCPeerConnection)

Note: As the first step of configuration, you will be asked to verify the connection to the air conditioner WiFi network. Therefore, go into the computer WiFi settings and select the corresponding network. If it was not already renamed during installation on smartphone, the WiFi will be called **Innova2.0**. After which, click **Done**.



Figure 2-44



Figure 2-45



Figure 2-46

Note: In order to make InnovApp TwoPointZero work on your desktop, you must have Java installed on the PC.

Note: See also paragraph “Control with several devices”

2.14 Troubleshooting

Effect	Causa	Solution
The air conditioner cannot be configured on the iOS smartphone	iOS smartphones do not automatically identify the WiFi network which was renamed during configuration of the App.	Go to the telephone's settings and select the 2.0 unit's WiFi network with the name assigned to it during configuration of the App.
Remote configuration is unsuccessful	The WiFi network may be weak.	Check the signal power
The air conditioner's WiFi cannot be found	The WiFi transmitter may be switched off OR the air conditioner may already be configured in "Remote control"	Ensure that there is power to the device
Several air conditioners in the house cannot be configured	During configuration, two or more air conditioners are on	Configure one air conditioner at a time: therefore, switch on one at a time, keeping all the others off, and start the configuration.
The air conditioner cannot be controlled through the App	The problem is connected to the version of the air conditioner.	The version that allows control of the air conditioner through the App is 1.0.36. Check your version by accessing the app menu: one of the menu items must be "firmware: 1.0.36". In the case of a previous version, contact INNOVA service.
During configuration of the remote control, the WiFi network does not work	The password contains special characters	Enter a new password using only the permitted alphanumeric characters: from "A" to "Z" (uppercase and lowercase), from "0" to "9", "-", "_", ".". Special characters are not permitted.
The air conditioner scheduling section cannot be accessed	Scheduling of the 2.0 is possible only after remote control has been configured.	Ensure that you have configured remote control, accessing the dedicated section from the App menu. Otherwise, configure it as explained on page 15.
Immediately after carrying out remote configuration, the name of the air conditioner is "TEMP"	This is a synchronisation problem between the air conditioner, the server and the smartphone.	Wait a few minutes. Otherwise, shut down and restart the air conditioner.
MQTT Server Problem	The server is in maintenance	Wait
Faults on the display: errors E7, E6 and other alarms		See page 10



Getting In Touch

Powrmatic Limited
Hort Bridge, Ilminster
Somerset
TA19 9PS
tel: **+44 (0) 1460 53535**
fax: **+44 (0) 1460 52341**
e-mail: **info@powrmatic.co.uk**
web: **www.powrmatic.co.uk**



Powrmatic Ireland
45 Broomhill Close
Tallaght
Dublin 24
tel: **+353 (0) 1452 1533**
fax: **+353 (0) 1452 1764**
e-mail: **info@powrmatic.ie**
web: **www.powrmatic.ie**

More information is available from our website by scanning the following QR code.



Powrmatic pursues a policy of continues improvement in both design and performance of its products and therefore reserves the right to change, amend or vary specifications without notice. Whilst the details contained herein are believed to be correct they do not form the basis of any contract and interested parties should contact the Company to confirm whether any material alterations have been made since publication of this brochure.