

POWRMATIC®

Vision

Installation & Servicing Manual

Issue 2.0 Apr 2026



Certificate Of Guarantee

POWRMATIC® Certificate of Guarantee

This is to certify that this air conditioner has a 3-year parts only warranty from the date of original installation.

To make a claim

In the first instance you must contact your appliance supplier, or installer and provide:-

1. The appliance type and serial number.
2. A copy of the registration documentation. As much detail as possible on the fault.
3. Your supplier, or installer, will then contact Powrmatic to make a guarantee claim on your behalf.

Conditions of Guarantee

1. The air conditioner must have been installed by a competent installer, and in accordance with the manufacturer's instructions and any building regulations and local regulations.
2. A copy of the registration form must be returned to Powrmatic.
3. The air conditioner has been maintained on a yearly basis by a competent and qualified servicing company.
4. The air conditioner has been used in accordance with the manufacturer's instructions.
5. The correct specification voltage has been used.
6. No unauthorised repairs or modifications have been made. Powrmatic 'General Conditions of Sales' have been observed.
7. Except for the obligation of Powrmatic Ltd to perform warranty repairs during the guarantee period, Powrmatic will not be liable in respect of any claim for direct or indirect consequential losses, including loss of profits or increased cost arising from loss of use of the heater, or any event arising there from.

Exclusions

Consumables such as control batteries are all excluded from guarantee.

Powrmatic Ltd, Hort Bridge, Ilminster, Somerset, TA19 9PS
Tel: 01460 53535 **Fax: 01460 52341**
Web: www.powrmatic.co.uk **e-mail: warranty@powrmatic.co.uk**

**Important: This certificate
must be kept with the appliance**

Failure to provide a copy of the commissioning sheet invalidates the heater warranty

Dear Customer - thank you for choosing Powrmatic.

We appreciate you buying one of our high quality products and know that you have made the best choice. By choosing Powrmatic, you are investing in UK manufacturing & its workforce. We pride ourselves by manufacturing products that provide clean, comfortable and safe working environments worldwide together with the personal & professional service and back-up you deserve. If you have any questions or concerns regarding this product, please contact our Technical Support Team by calling 01460 53535.

This booklet consists of 60 pages.

Conformity

This unit complies with the European directives:

- EN 60335-2-40 Household and similar electrical appliances - Safety Part 2-40: Particular requirements for electrical heat pumps, air-conditioners and dehumidifiers
- Low voltage 2014/35/EU
- EMC 2014/30/EU
- RED 2014/53/EU on the harmonisation of the laws of the Member States relating to the making available on the market of radio equipment
- RoHS 2011/65/UE
- 2017/1369/EU on energy labelling
- 2009/125/CE implementing regulation 206/2012/EU and Italian implementing regulation Legislative Decree no. 15 of 16/02/2011
- F-Gas Regulation 2014/517/EU on fluorinated greenhouse gases

And subsequent amendments.

 For declarations of conformity, certificates and other certification details please consult the website.

Markings



Contents

1. Coding 4

1.1 Product related coding 4

2. General information 5

2.1 About the manual 5

2.2 General warnings 6

2.3 Basic rules of security 7

2.4 Disposal 7

3. Product presentation 9

3.1 Identification 9

3.2 Destination of use 9

3.3 Description of the appliance 9

3.4 Components 10

3.5 Compatible accessories 10

4. Installation 13

4.1 Preliminary warnings 13

4.2 Reception 13

4.3 Dimensions and weights with packaging 14

4.4 Handling with packaging 14

4.5 Storage 15

4.6 Unpacking 15

4.7 Handling without packaging 16

4.8 Installation site 16

4.9 Installation mode 17

4.10 Installation minimum distances 18

4.11 Positioning 18

4.12 Condensation drain preparation 22

4.13 Electric connections 24

4.14 High/low installation configuration 26

4.15 Operations after installation 27

4.16 Removal of aesthetic panels and grilles 27

4.17 Assembly of aesthetic panels and grilles 29

5. Touchpad and remote control 30

5.1 Interface 30

5.2 Basic menu 30

5.3 Advanced Menu 31

5.4 Visualisation of alarms on display 33

6. M7 series control EEB749 34

6.1 Interface 34

6.2 Installation 35

6.3 Single connection diagram 36

6.4 Connections 37

6.5 Basic menu 37

6.6 Advanced Menu 39

6.7 Alarm display on wall control panel 39

7. M7 Series Commands EFB749 40

7.1 Interface 40

7.2 Installation 41

7.3 Single connection diagram 42

7.4 Multiple connection diagram 43

7.5 Connections 44

7.6 Functions 45

8. Maintenance 48

8.1 Preliminary warnings 48

8.2 Routine maintenance 48

8.3 Replacement of UV lamp kit 49

9. Troubleshooting 50

9.1 Troubleshooting table 50

9.2 Diagnosis of possible anomalies 50

9.3 Visualisation of alarms on display 51

10. Technical information 52

10.1 Technical data 52

10.2 Dimensions 54

10.3 RED Compliance Statement 54

10.4 Safety 55

10.5 FCC Declaration of Conformity 55

1.1 Product related coding

This instruction manual refers to the following product codes.





⚠ Check the correspondence with the technical rating plate on the product. See chapter "Identification" p. 9.

Vision 2.3, Vision 3.1, Vision 3.1 Elec

2. GENERAL INFORMATION

2.1 About the manual





This manual was written to provide all the explanations for the correct management of the device.

-  This instruction manual forms an integral part of the device and therefore must be carefully preserved and must ALWAYS travel with it, even if you transfer the device to another owner or relocate it to other premises. If the manual gets damaged or lost, download a copy from the website.
-  Read this manual carefully before proceeding with any operation and follow the instructions in the individual chapters.
-  The Manufacturer accepts no liability for damages to persons or property caused by failure to follow the instructions in this manual.
-  This document is restricted in use to the terms of the law and may not be copied or transferred to third parties without the express authorisation of the Manufacturer.

2.1.1 Editorial pictograms

The pictograms in the next chapter provide the necessary information for correct and safe use of the machine in a rapid and unmistakable way.

Related to security

-  **High risk warning (bold text)**
 - The operation described above presents a risk of serious physical injury, fatality, major damage to the device and/or to the environment if not carried out in compliance with safety regulations.
-  Low risk warning (plain text)
 - The operation described above presents a risk of minor physical injury or minor damage to the device and/or to the environment if not carried out in compliance with safety regulations.
-  Prohibition (plain text)
 - Refers to prohibited actions.
-  **Important information (bold text)**
 - This indicates important information that must be taken into account during the operations.



In the texts

- ▶ procedures
- lists

In the control panels

- ▶ actions required
Expected responses following an action.

In the figures

- 1 The numbers indicate the individual components.
- A The capital letters indicate component assemblies.
-  The white numbers in black marks indicate a series of actions to be carried out in sequence.
-  The black letter in white identifies an image when there are several images in the same figure.

2.1.2 Pictograms on the product

Symbols are used in some parts of the device:

Related to security



Read instruction manual

- Read the instructions carefully before performing any work on the device.



Instruction manual

- Read the information available in the technical documentation of the device.



Caution: electrical danger

- The concerned personnel is informed to the presence of electricity and the risk of suffering an electric shock.

Related to refrigerant R32



Caution: low flammability material

- R290 refrigerant gas is flammable and odourless. Avoid proximity to ignition sources in continuous operation (open flames, gas appliances, electric stoves, burning cigarettes, etc.).



Instructions for the Authorised Service Centre

- The Authorised Service Centre must read the instructions carefully before performing any work on the appliance.

2.1.3 Recipients

User

Non-expert person capable of operating the product in safe conditions for people, for the product itself and the environment, interpreting an elementary diagnostic of faults and abnormal operating conditions, carrying out simple adjustment, checking and maintenance operations.

Installer

Expert person qualified to position and connect (hydraulically, electrically, etc.) the unit to the plant; this person is responsible for handling and correct installation according

General

to the instructions provided in this manual and the national standards currently in force.

To work on the refrigeration circuit, the installer must comply with the provisions of Regulation 303/2008/EC which defines, in accordance with Directive 842/2006/EC, the requirements for companies and personnel with regard to fixed refrigeration, air conditioning and heat pump equipment containing certain fluorinated greenhouse gases (F-gas licence).

Authorized Service Center

Expert and qualified person authorised directly by the manufacturer to carry out all routine and supplementary maintenance operations, as well as every adjustment, check, repair and replacement of parts necessary during the life of the unit itself.

Service personnel must comply with the provisions of Regulation 303/2008/EC which defines, in accordance with Directive 842/2006/EC, the requirements for companies and personnel with regard to fixed refrigeration, air conditioning and heat pump equipment containing certain fluorinated greenhouse gases (F-gas licence).

2.1.4 Manual organization

The manual is divided into sections each dedicated to one or more target groups.

Coding

It addresses all recipients.

It contains the list of products and/or accessories referred to in the manual.

General information

It addresses all recipients.

It contains general information and important warnings that should be known before installing and using the device.

Product presentation

It addresses all recipients.

It contains the information to identify the product, its components, compatible accessories and destination of use.

Installation

It is addressed exclusively to the installer.

It contains specific warnings and all the information necessary for positioning, mounting and connecting the appliance.

Commissioning, maintenance and troubleshooting

They are addressed exclusively to the Authorized Service Center.

It contains specific warnings useful information for the most common commissioning and routine maintenance.

Technical information

It addresses all recipients.

It contains detailed technical information about the appliance.

2.2 General warnings

- ⚠ Specific warnings are given in each chapter of the document and must be read before starting operations.
- ⚠ All personnel involved must be aware of the operations and dangers that may arise when beginning all unit installation operations.
- ⚠ Installation performed outside the warnings provided in this manual and use of the appliance outside the prescribed temperature limits will invalidate the warranty.
- ⚠ The installation and maintenance of climate control equipment could be dangerous because there is pressurised refrigerant gas and live electrical components inside the appliances. The installation and subsequent maintenance phases must be carried out exclusively by authorised and qualified personnel.
- ⚠ Any contractual or extra-contractual liability for damage caused to persons, animals or property, due to installation adjustment and maintenance errors, or improper use, is excluded. All uses not expressly indicated in this manual are not permitted.
- ⚠ Only suitably qualified installers are authorized to install the device. After having completed installation, the installer will issue a declaration of conformity to the plant manager, as required by the applicable standards and the guidelines provided by contractor's instruction manual supplied with the device.
- ⚠ First start-up and repair or maintenance operations must be carried out by the Technical Assistance Center or by qualified personnel following the provisions of this manual.
- ⚠ Do not modify or tamper with the appliance as this can lead to dangerous situations.
- ⚠ Use suitable personal protective clothing and equipment during installation and/or maintenance operations. The Manufacturer is not liable for the non-observance of the current safety and accident prevention regulations.
- ⚠ Do not use any means or tools to accelerate the defrosting process or for cleaning other than those recommended by the manufacturer.
- ⚠ The appliance must be stored in a room without sources of injection in continuous operation (e.g. open flames, a gas appliance in operation or an electric heater in operation).
- ⚠ In the event of liquid or oil leaks, set the main switch of the plant to "OFF" and isolate water taps where applicable. Call the Authorized Service Center or professionally qualified personnel as soon as possible and do not work on the appliance yourself.
- ⚠ In case of replacement of parts, use only original parts.
- ⚠ The Manufacturer reserves the right to make changes to its models at any time to improve its product, without prejudice to the essential characteristics described in this manual. The manufacturer is not obliged to add such modifications to machines previously manufactured, already delivered or under construction.

- ⚠ The unit can be used by children over the age of 8, and by people with reduced physical, sensory or mental capabilities, or with no experience or necessary knowledge, as long as they are monitored or after they have received instructions on the safe use of the unit and have understood the dangers involved. Children must not play with the appliance. The cleaning and maintenance that must be performed by the user should not be carried out by children without supervision.

2.2.1 Specific warnings for R32

- ⓘ **This document contains only some of the warnings related to the refrigerant R32. For more comprehensive information, carefully read the safety data sheet available from the dealer.**
- ⚠ Each chapter contains specific warnings for the operations it describes. These warnings must be read before starting activities.

2.3 Basic rules of security

Please keep in mind that the use of products powered by electricity and water call for operators to comply with certain essential safety rules:

- ⊖ The use of the appliance by children and unassisted disabled persons is prohibited.
- ⊖ It is forbidden to touch the device with wet or damp body parts.
- ⊖ It is forbidden to carry out any operation before disconnecting the appliance from the power supply by setting the plant main switch to "OFF".
- ⊖ It is forbidden to modify the safety or adjustment devices, or adjust without authorization and indications of the Manufacturer.
- ⊖ It is forbidden to pull, unplug or twist the device's electric cables, even if it is disconnected from the mains.
- ⊖ It is forbidden to introduce objects and substances through the air inlet and outlet grilles.

- ⚠ All precautions concerning the treatment of the refrigerant must be observed following the regulations in force.
- ⚠ The unit uses environmentally friendly R32 refrigerant gas, with a Global Warming Potential (GWP) = 675. Do not release R32 gas into the atmosphere.
- ⚠ R32 refrigerant gas is mildly flammable and odourless.
- ⚠ Do not place flammable objects (spray cans) within 1 metre of the air outlet.
- ⚠ Avoid proximity to sources of ignition in continuous operation (open flames, gas appliances, electric stoves, lighted cigarettes, etc.).
- ⚠ If refrigerant gas escapes, ventilate the room abundantly and leave. Call the Authorised Service Centre or professionally qualified personnel as soon as possible and do not intervene on the appliance yourself.

- ⊖ It is forbidden to open the access doors of the device's internal parts without first having set main switch of the system to "OFF".
- ⊖ It is forbidden to incorrectly dispose of the packaging, or leave in the reach of children, which may become a source of danger.

2.3.1 Specific safety rules for R32

This document contains only some of the safety rules related to refrigerant R32. For more comprehensive information, carefully read the safety data sheet available from the dealer.

- ⊖ Smoking in the vicinity of the appliance is prohibited.
- ⊖ Using a mobile phone near the appliance is prohibited.
- ⊖ Using leak detectors with halogen lamps is prohibited.

2.4 Disposal



The symbol on the product or packaging indicates that the product must not be treated as normal household waste, but must be taken to the appropriate collection point for

recycling of used electrical and electronic equipment and batteries.

Proper disposal of this product avoids harm to humans and the environment and promotes the reuse of valuable raw materials.

For more detailed information about the recycling of this product, contact your local authority, your household waste disposal service or the shop where you purchased the product.

Illegal disposal of the product by the user involves the application of the administrative sanctions provided for by the regulations in force.

This provision is valid in the EU Member States.

- ⚠ Avoid disassembling the unit yourself.

General

⚠ This unit contains fluorinated greenhouse gases covered by the Kyoto Protocol. Maintenance and disposal operations must be carried out by qualified personnel only.

⚠ **Contact an Authorized Service Center to disassemble the appliance.**



This symbol might be used in combination with a chemical symbol.

In this case, it complies with the requirement set by the Directive for the chemical involved.

3. PRODUCT PRESENTATION

3.1 Identification

The appliance can be identified by the rating plate:

Technical rating plate

- ⚠ According to EU Regulation No. 517/2014 concerning certain fluorinated greenhouse gases, it is mandatory to indicate the total amount of refrigerant present in the installed system. This information can be found on the rating plate of the unit.
- ⚠ Tampering with, removal of, or lack of identification plates will not allow for the safe identification of the product by its serial number and therefore invalidates the warranty.

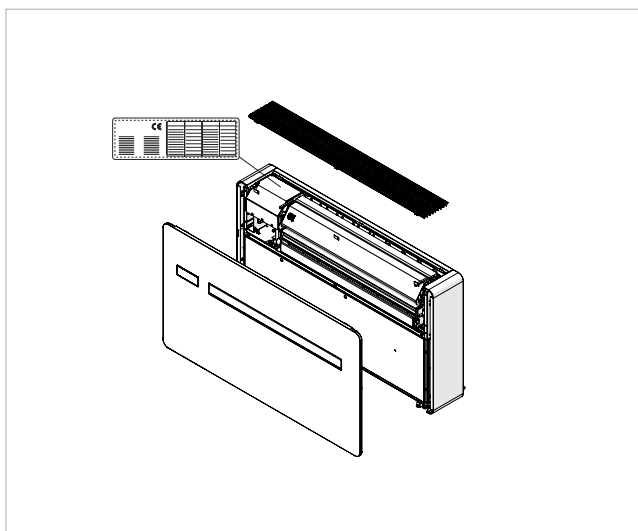

3.2 Destination of use

These appliances have been designed for conditioning and/or heating rooms and they must be destined solely for

this purpose, in accordance with their performance characteristics.

⊖ It is forbidden to use the device other than as indicated.

3.3 Description of the appliance

The Vision range of air conditioners without an external unit are designed for indoor installation on a perimeter wall at the top or bottom, in a vertical position.

Inverter technology allows you to optimise the power for maximum comfort. The Dual Power function allows the required temperature to be reached in the shortest possible time (Inverter models only). Control is via a touch panel located on the unit or via a remote control.

The appliance uses the refrigerant R32.

All models are heat pump models and are made in different sizes and performance:

10 HP DC Inverter: with modulating control

12 HP DC Inverter: with modulating control

12 HP DC Inverter ELEC 2 kW: with electric resistance

General

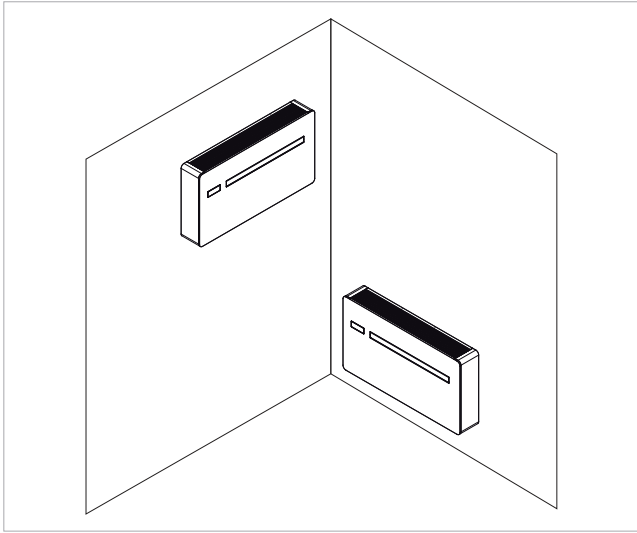

3.4 Components

1.	Control Panel
2.	Air outlet deflector
3.	Aesthetic front panel
4.	Intake grille
5.	Aesthetic side panel
6.	External air intake
7.	External air expulsion
8.	Condensate drain
9.	Anti-lifting bracket
10.	Remote control
11.	Terminal block
12.	Air filter



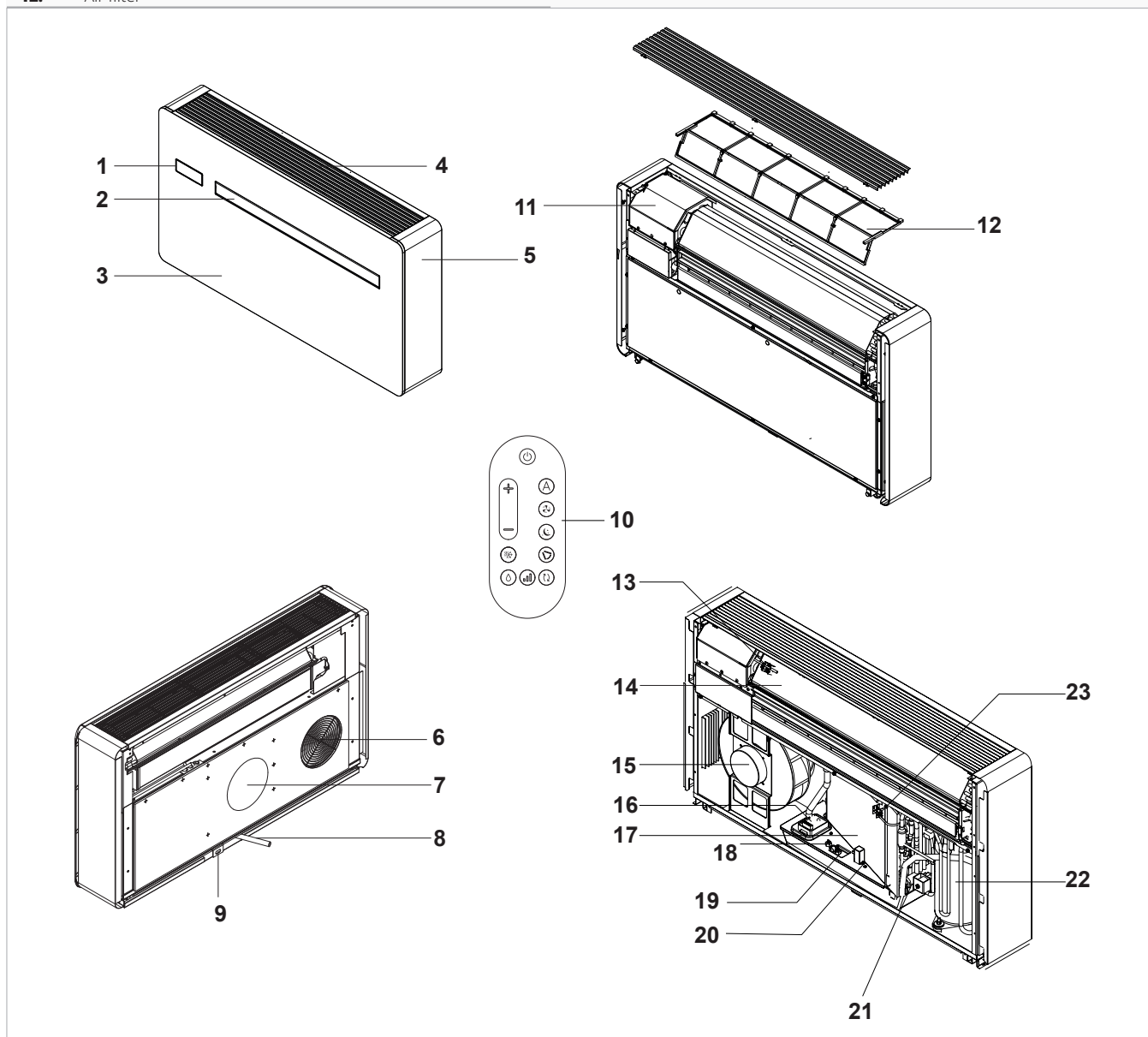



13.	Room air probe
14.	Internal exchanger
15.	External fan
16.	Condensation pump
17.	External exchanger
18.	Maximum level float
19.	Level float
20.	Condensation drain valve
21.	Four-way valve
22.	Compressor
23.	External air probe

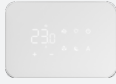

3.5 Compatible accessories

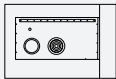
⚠ The accessories table refers to all products in the Vision range. Please check the column Combinable products for correspondence with the purchased size.

General

Accessory description		Combinable products	Code
Wall mounted control panels M7 series			
Control panels			
	LED electronic control panel with touch interface, wall-mounted complete with thermostat and room temperature and relative humidity probe. Cable connection. Dimensions (lxhxp): 117x80x5 mm. Colour white	All	EEB749II
	LED electronic control panel with touch interface, wall-mounted complete with thermostat and room temperature and relative humidity probe with integrated Wi-Fi module, new App. Cable connection. Dimensions (lxhxp): 117x80x5 mm. Colour white	All	EFB749II
Built-in boxes			
	Built-in box for masonry	All	N000557A
	Built-in plasterboard box	All	N000558A
Configuration accessories			
Heated condensate drainage pipe			
	Condensate disposal pipe heated with electric resistance.	All	GB1119II
Accessories supplied separately			
Pre-installation kit			
	Kit consisting of: paper template, external grilles DN 160 mm, wall fixing bracket, pipes for holes, crews and dowels	Vision 3.1 DC INVERTER Vision 2.3 DC INVERTER Vision 3.1 ELEC DC INVERTER	GB0671II
	Kit consisting of: paper template, external grilles DN 200 mm, wall fixing bracket, pipes for holes, crews and dowels	Vision Maxi DC INVERTER Vision Maxi ELEC DC INVERTER Vision Titan DC INVERTER	GB1092II
	Kit consisting of: paper template, external grilles DN 160 mm, wall fixing bracket, pipes for holes, crews and dowels	Vision Mini DC INVERTER	GB1109II
Side exit formwork			
	Recessed formwork for corner installation with right-hand exit, depth: 165 mm	Vision 3.1 DC INVERTER Vision 2.3 DC INVERTER Vision 3.1 ELEC DC INVERTER	L00773II
	Recessed formwork for corner installation with left-hand exit, depth: 165 mm	Vision 3.1 DC INVERTER Vision 2.3 DC INVERTER Vision 3.1 ELEC DC INVERTER	L00774II
Grille and other accessories			
	Kit n. 2 external grilles with fixed fins DN 160 for outdoor	Vision 3.1 DC INVERTER Vision 2.3 DC INVERTER Vision Mini DC INVERTER .Vision 3.1 ELEC DC INVERTER	GB0738II
	Rain protection kit. Applicable only on fixed grille. DN 160	Vision 3.1 DC INVERTER Vision 2.3 DC INVERTER Vision Mini DC INVERTER .Vision 3.1 ELEC DC INVERTER	GB0739II
	Kit n. 1 insect protection kit for intake hole only. Can only be applied to fixed outside grilles DN 162 mm.	Vision 3.1 DC INVERTER Vision 2.3 DC INVERTER Vision Mini DC INVERTER .Vision 3.1 ELEC DC INVERTER	GB0755II
	Kit n. 2 external grilles with fixed fins DN 200 for outdoor	Vision Maxi DC INVERTER Vision Maxi ELEC DC INVERTER Vision Titan DC INVERTER	GB1091II

4. INSTALLATION

4.1 Preliminary warnings

- ⚠ **This section is dedicated to the Installer. The features of the installer are described in the "Recipients" p. 5 chapter.**
- ⚠ **For detailed information on the products, refer to chapter "Technical information" p. 52**
- ⚠ The installation must be carried out by the installer in accordance with national installation regulations. There is a risk of water leakage, electric shock or fire if the installation is not performed correctly.
- ⚠ During the installation, it is necessary to observe the precautions mentioned in this manual, and on the labels placed inside the equipment, as well as to adopt any precaution suggested by common sense and by the Safety Regulations in force in the place of installation.
- ⚠ Be sure to use the supplied or specified installation parts. Use of other parts may cause the unit to come loose, leak water, or cause electrical shock, or fire.
- ⚠ The Manufacturer accepts no liability for damage caused to animals or property due to failure to apply the indicated rules which may cause malfunction of appliances.
- ⚠ The air conditioners without an external unit are designed for indoor installation. The only components suitable for outdoor use are the external grilles for air inlet and outlet.

4.1.1 Preliminary warnings for R32

- ⚠ Safety checks must be carried out to ensure that the risk of combustion is minimised before starting work on systems containing flammable refrigerants.
- ⚠ The appliance must be protected against accidental impacts to prevent mechanical damage.
- ⚠ Do not puncture or burn.

4.2 Reception

4.2.1 Preliminary warnings

- ⚠ On receipt check for any damage and, if any is found, accept the goods with reservation, and keep photographic evidence of any damage found
- ⚠ The package must be transported in an upright position; otherwise, notify the carrier immediately.
- ⚠ In the event of damage, notify the shipper within 3 days of receipt of any damage by registered mail with return receipt, submitting photographic evidence. Similar information should be sent by fax to the manufacturer (jurisdiction will be at the Court Trento for any dispute).
- ⚠ No notice of damage will be accepted after 3 days from delivery.
- ⚠ Unpack and check the contents of individual components against the packing list.

4.2.2 Package description

The packaging is made of suitable material and carried out by experienced personnel.

All units are checked and tested and are delivered complete and in perfect condition.

The appliance is shipped in standard packaging consisting of a cardboard sleeve and a set of expanded polystyrene protectors.

Installation

4.3 Dimensions and weights with packaging

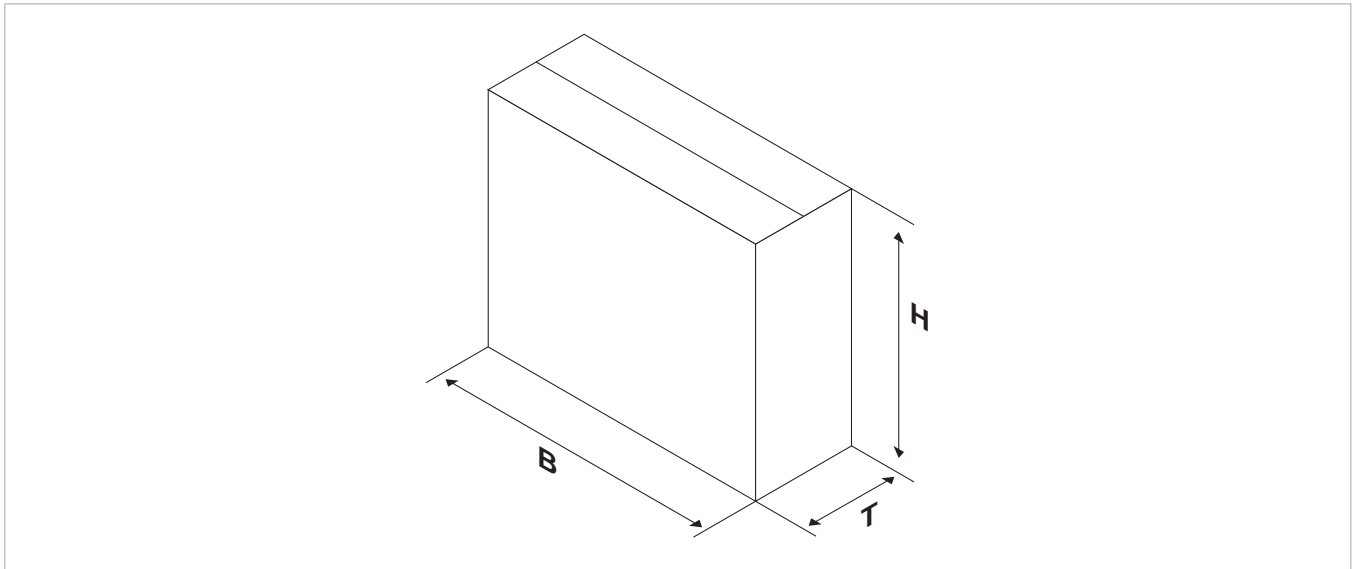

Models	u.m.	Vision 2.3	Vision 3.1	Vision 3.1 Elec
Dimensions and weight for shipping				
Width	mm	1100	1100	1100
Height	mm	670	670	660
Total depth	mm	255	255	260
Weight	kg	45,0	45,0	45,0

4.4 Handling with packaging

4.4.1 Preliminary warnings

- ⚠ The appliance must be handled only by qualified personnel, adequately equipped and with equipment suitable for the weight and dimensions of the appliance.
- ⚠ Stay clear of the area below and around it when the load is lifted off the ground.
- ⚠ Avoid dangerous situations when using a hoist to lift the appliance.
- ⚠ During transportation, the unit must be kept in vertical position.

4.4.2 Movement methods

Boxes can either be carried singularly by hand by two operators or loaded on a forklift truck evenly stacked.

- ⚠ Check the indications on the packaging for the number of packages that may be stacked together.
- ⚠ In manual operation it is compulsory to always respect the maximum weight per person provided for by the national laws and standards.
- ⚠ Use the handles provided on the packaging.

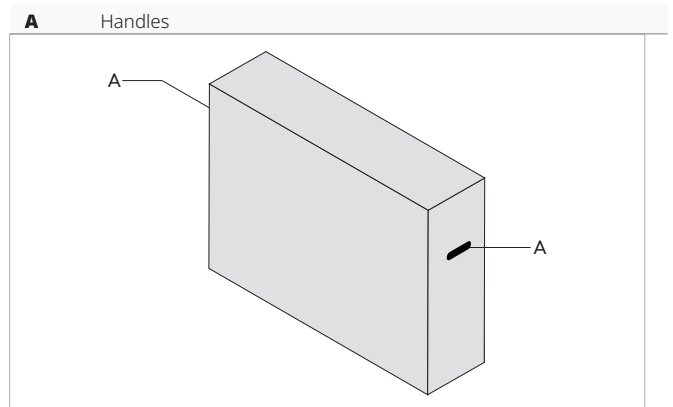

4.5 Storage

4.5.1 Preliminary warnings

- ⚠ Store in accordance with the applicable national regulations.
- ⚠ Store the box in a closed environment protected from atmospheric agents and isolate it from the floor using planks or pallets.
- ⚠ Do not turn the packaging upside down.
- ⚠ Only place the appliance in a vertical position.

- ⚠ Store in a clean and dry place.

Specific warnings for R32

- ⚠ Store the unit in such a way as to avoid mechanical damage.
- ⚠ Check the national/local legislation in force, regarding fire regulations. The refrigerant contributes to the fire load.

4.6 Unpacking

4.6.1 Preliminary warnings

- ⚠ Check that no components were damaged during transport.
- ⚠ Dispose of the packaging components following the applicable waste disposal regulations. Check for disposal arrangements with your municipality.
- ⚠ Handle with care.
- ⚠ The equipment must always be handled vertically.
- ⚠ Check if there is refrigerant inside the package using an electronic leak detector suitable for the system refrigerant. If it is present, the refrigeration circuit is likely damaged. In this case, do not install the appliance and call the Authorised Service Centre.

- ⊖ The packing material (cardboard, staples, plastic bags, etc.) must not be dispersed or abandoned in the surrounding environment and must be kept out of the reach of children, as it poses a risk of danger.

Specific warnings for R32

- ⚠ Check that there are no sources of ignition in continuous operation (open flames, gas appliances, electric stoves, lighted cigarettes, etc.).
- ⊖ Using leak detectors with halogen lamps is prohibited.
- ⊖ Smoking in the vicinity of the appliance is prohibited.
- ⊖ Using a mobile phone near the appliance is prohibited.

4.6.2 Remove the package

1. Polystyrene elements

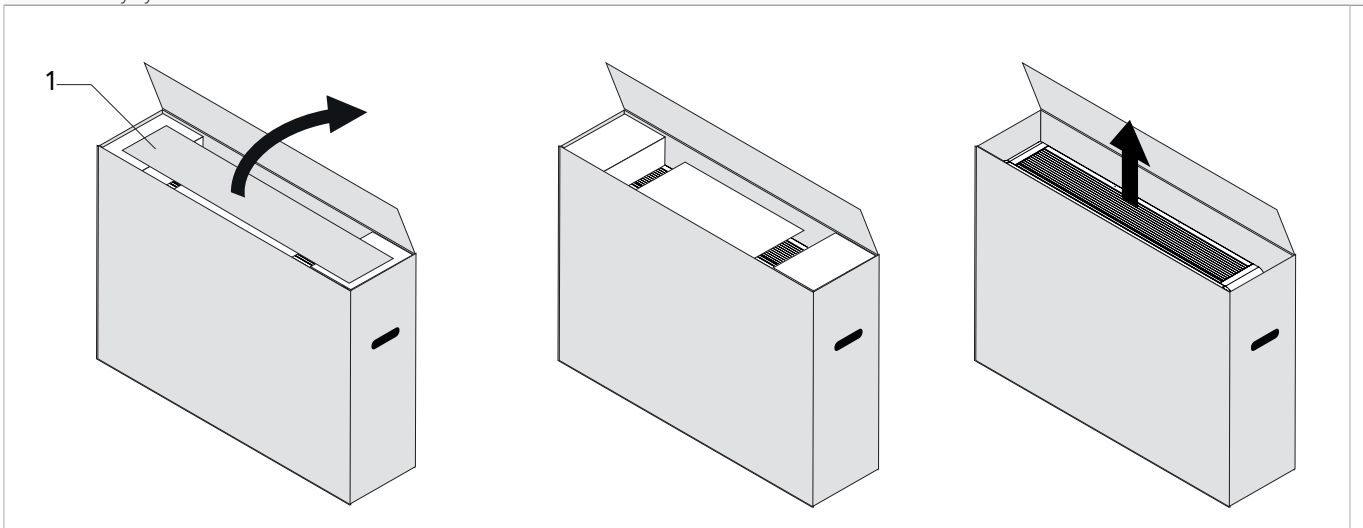

Remove the packing:

- ▶ open the cardboard packaging
- ▶ remove the polystyrene elements

- ▶ remove the accompanying components
- ▶ remove the appliance from the box

Accompanying material

They are included with the appliance, inside the packaging:

- ⚠ Check the presence of the individual components.

Installation

A	External fixed grille for air inlet and outlet (2 pcs front view)	G	CR2025 3V remote control battery
B	Screws and dowels kit (6 pcs)	H	Wall-mounted roll-up tubes (2 pcs)
C	Wall mounting bracket	I	Energy efficiency label
D	Instruction sheet for manual download	J	QR Code scan label
E	Remote control	K	Internal flanges
F	Paper template for holes		

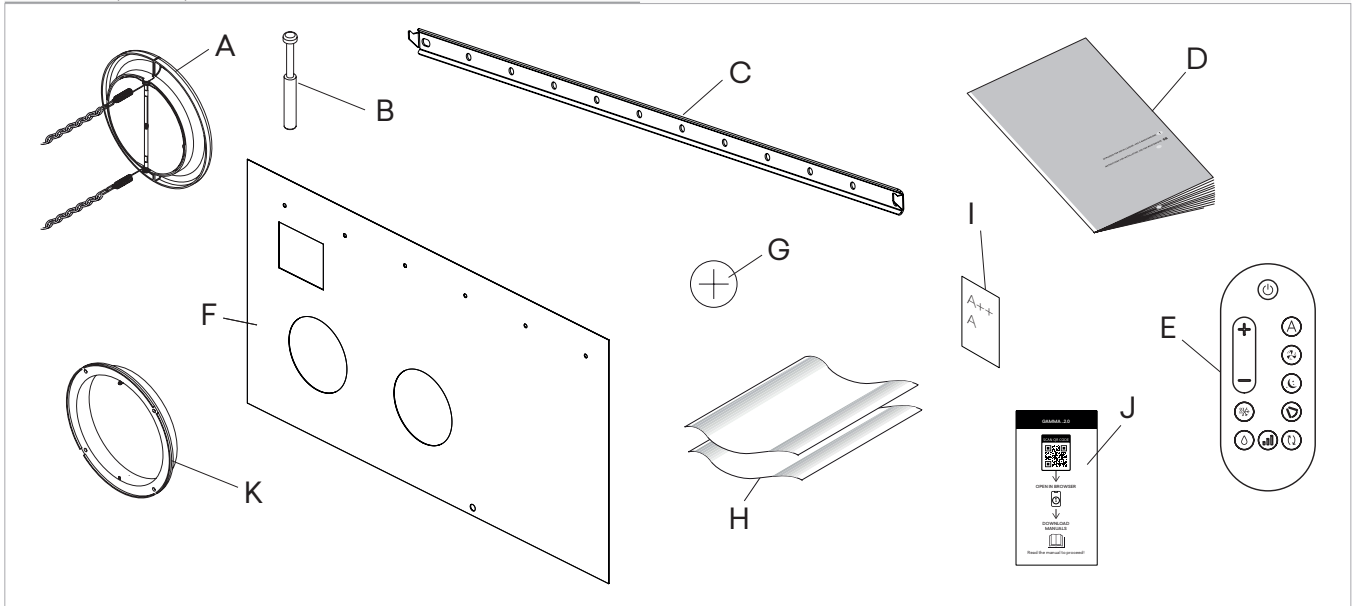

In case of lost, the installation template is available on the website, in the download area.

4.7 Handling without packaging

4.7.1 Preliminary warnings

- ⚠ The appliance must be handled only by qualified personnel, adequately equipped and with equipment suitable for the weight and dimensions of the appliance.
- ⚠ The appliance is unbalanced on the right (compressor side)

4.7.2 Movement methods

- ⚠ The unit can be moved manually for short distances. In this case it is necessary to check carefully that the weight of the unit does not exceed the regulations in relation to the number of people used.

4.8 Installation site

The location of the appliance must be determined by the plant engineer or a competent person and must take into account both purely technical requirements and any national/local legislation in force.

This appliance is designed for vertical, low-wall or high-wall indoor installation.

- ⚠ The appliance must be installed against a wall communicating with the outside.
- ⚠ The appliance is stated as having an IPX0 protection rating, therefore it is not suitable for outdoor installation and in rooms with high levels of humidity (swimming pool rooms, etc.).
- ⚠ The unit can be installed at a maximum altitude of 2700 m.

4.8.1 Preliminary warnings

- ⚠ Avoid installing the unit near:

- obstacles or barriers that cause recirculation of the exhaust air
- narrow places where the sound level of the appliance can be enhanced by reverberations or resonances
- environments with the presence of flammable or explosive gases
- very humid environments (laundries, greenhouses, etc.)
- environments with aggressive atmospheres
- solar radiation and proximity to heat sources

- ⚠ Avoid placing the unit within 1 metre of radio and video equipment.
- ⚠ Do not install over heat sources.
- ⚠ Make sure that:
 - the installation site of the unit must be chosen with the utmost care to guarantee adequate protection from shocks and consequent damage

Installation

- the supporting structure is able to support the weight of the appliance
- the supporting structure section does not feature building supporting elements, pipes or power lines
- there are no obstacles to the free circulation of air through the holes (plants, leaves...)
- the appliance must be installed in a position where it can be easily serviced
- the safety distances between the units and other appliances or structures are scrupulously respected so that the air entering and leaving the fans is free to circulate

⚠ If the appliance is installed incompletely or on an inappropriate base, it could cause damage to persons or property if it should detach from its base.

⚠ The unit should not be installed in a position where the air flow is aimed directly at the people nearby.

- ⚠ Provide the following:
- a nearby drain for the outflow of condensate
 - a compliant power supply nearby
 - fixing elements suitable for the type of support

Preliminary warnings for R32

⚠ The installation of the unit does not have any special requirements (such as minimum area, room ventilation requirements or sensors) in relation to the use of refrigerants as the quantity used is less than 1.224 kg.

4.9 Installation mode

⚠ For ideal installation and performance levels, carefully follow the instructions in the manual.

⚠ Failure to do so may cause system malfunctions and automatically voids the warranty, and relieves the manufacturer of any harm caused to person, animals or property.

Installation

4.10 Installation minimum distances

The clearance zones for the installation and maintenance of the appliance are shown in the figure. Established spaces are necessary to avoid barriers to airflow and allow for normal cleaning and maintenance.

⚠ Make sure that there is sufficient space to allow the panels to be removed for routine and supplementary maintenance operations.

- A** High wall installation
- B** Low wall installation

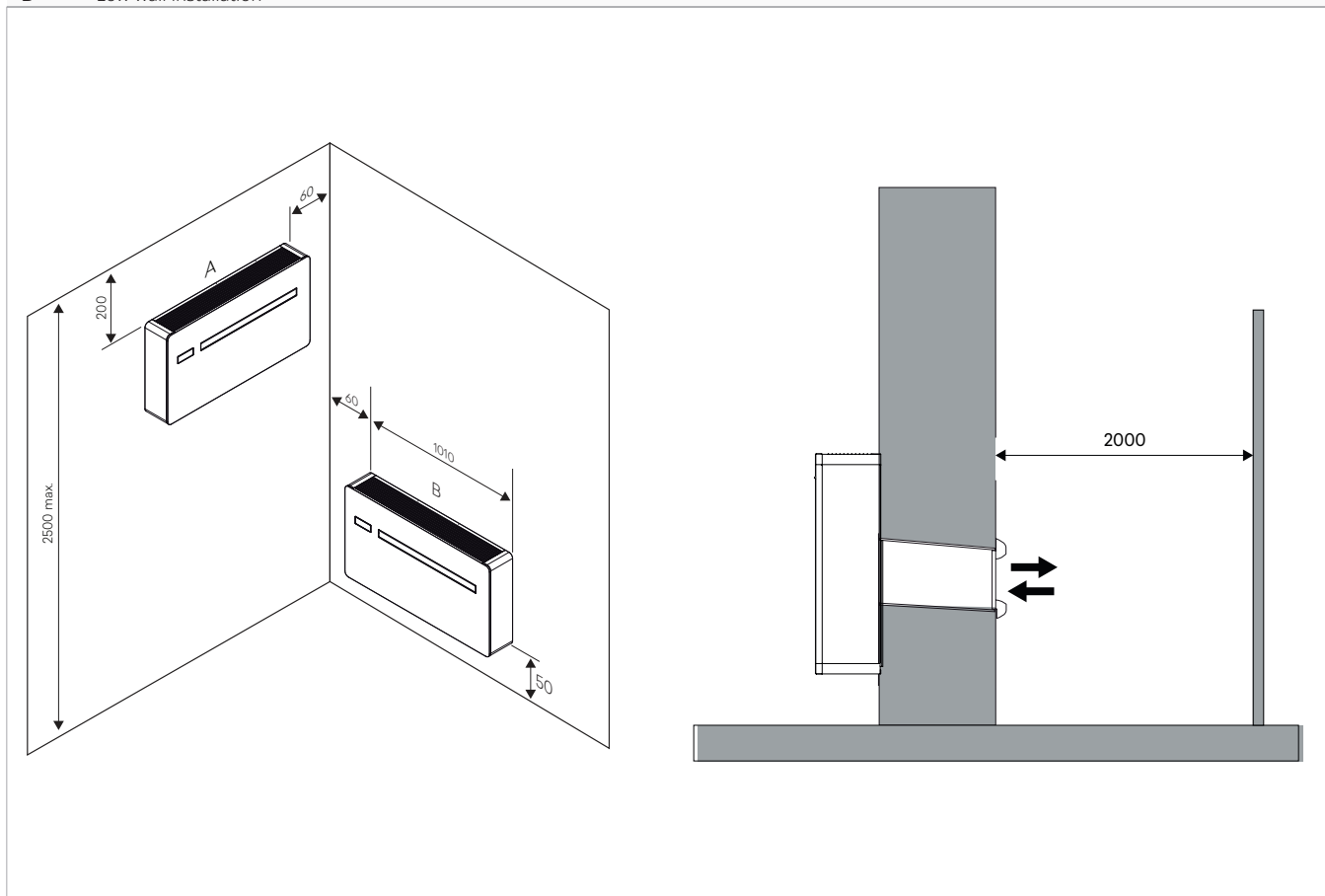

4.11 Positioning

The units can be wall-mounted upwards or downwards. The units are supplied with a paper template for marking the holes necessary for installation.

⚠ Hold the template in the correct position with tape.

A	Holes for M8 dowels
B	Electrical connection area
C	Ø162 mm holes for air channelling for models 10 HP DC Inverter - 12-HP DC Inverter - 12 HP DC Inverter ELEC 2 kW
D	Ø 18 mm condensate drain
E	anti-lifting bracket holed Ø 8 mm

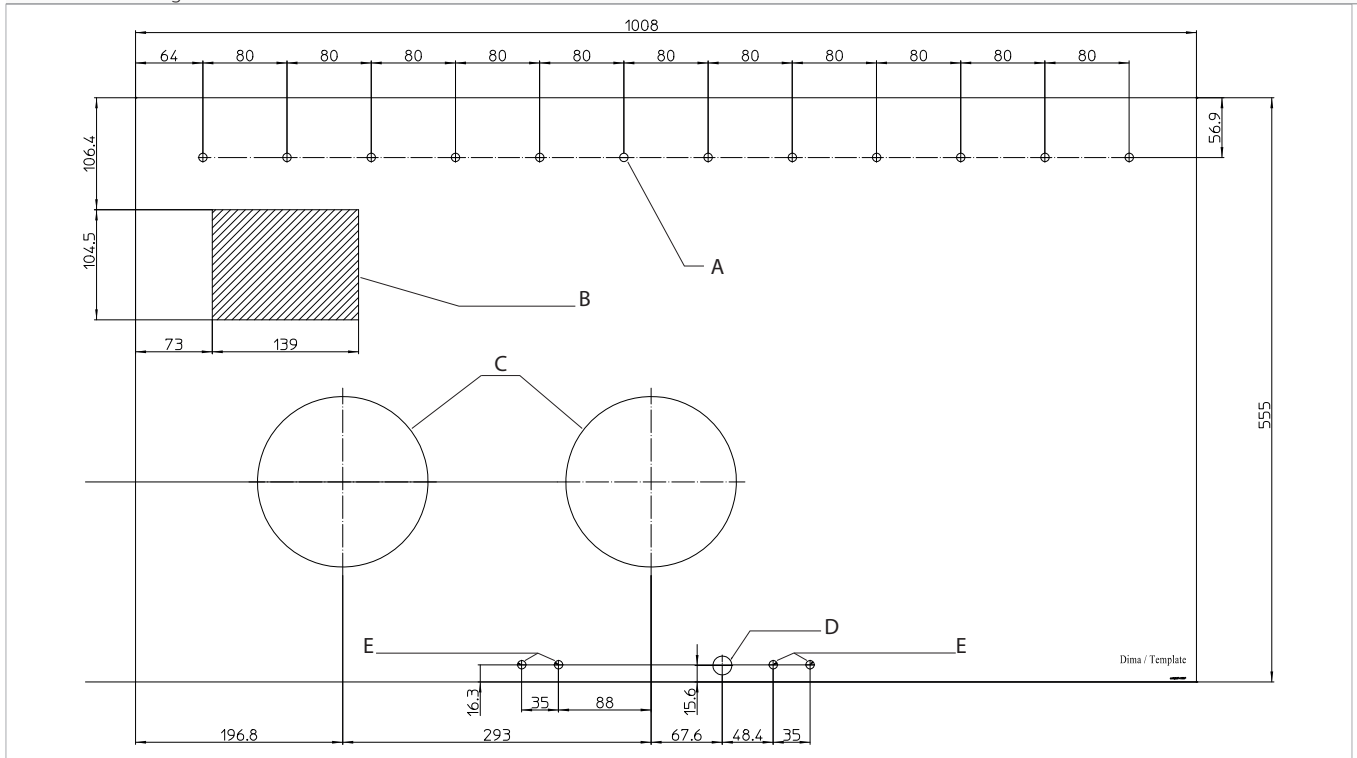

4.11.1 Preliminary warnings

- ⚠ The unit requires two or more people to position the unit.
- ⚠ The wall mounting bracket supplied as an accessory is required to position the unit on the wall.
- ⚠ Ensure that:
 - the wall supports the weight of the appliance
 - the section of the wall does not contain piping or electrical lines
 - the functionality of load-bearing elements is not compromised

Installation

4.11.2 Installation arrangement

Wall drilling for ducts

A	Side of the wall towards the interior
B	Side of the wall towards the exterior
1.	Perimeter wall
2.	Unit
3.	Return and expulsion grilles
4.	Outside air ducts

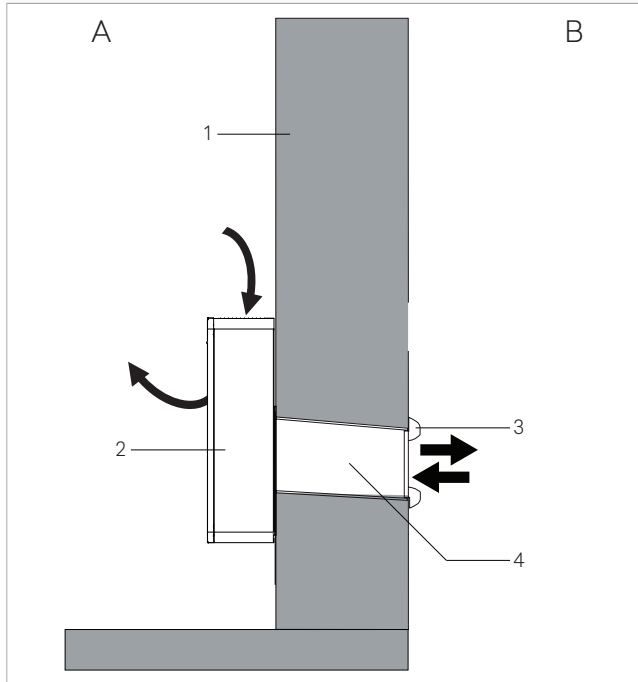

- ▶ position the paper template
- ▶ mark the positions of the holes for the ducts
- ▶ use a drill
- ▶ drill a pilot hole
- ▶ use a core drill
- ▶ drill the through hole into the wall
- ▶ keep a downward inclination toward the external side

⚠ The maximum length of the holes is 1 meter.

⊖ Curves are prohibited.

⚠ To prevent the creation of large quantities of dust and debris in the room it is recommended to couple the core drill to a vacuum system.

⚠ Proceed with caution in the vicinity of the outer wall in order to avoid the breakage of plaster around the hole.

⚠ Take precautions so that the drilled material does not fall on persons and objects below.

Positioning the ducts

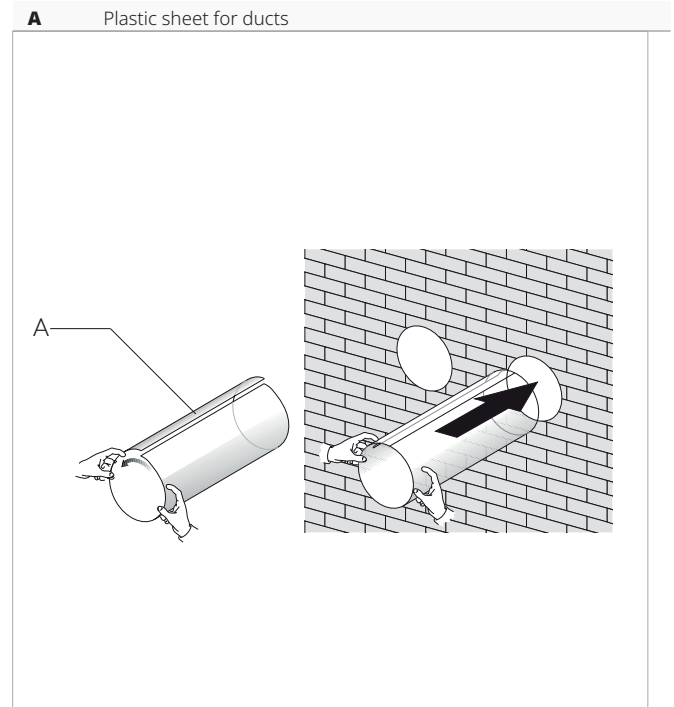

- ▶ measure the depth of the holes drilled in the wall
- ▶ subtract 5 mm from the measurement
- ▶ cut the plastic sheets supplied to size
- ▶ roll the plastic sheet
- ▶ insert the rolled sheet into the hole
- ▶ position so that the edges of the sheet are 2 mm inside both ends of the hole

Positioning outside air dampers

Before proceeding with the installation of the external air dampers, it is necessary to discern the one to be positioned on the air intake from the one intended for the expulsion. The dampers are identified with the labels:

IN: air intake damper

OUT: air delivery damper

⚠ Use only the dampers supplied with the unit.

Installation

1. Paper template
2. Air intake damper
3. Air expulsion damper

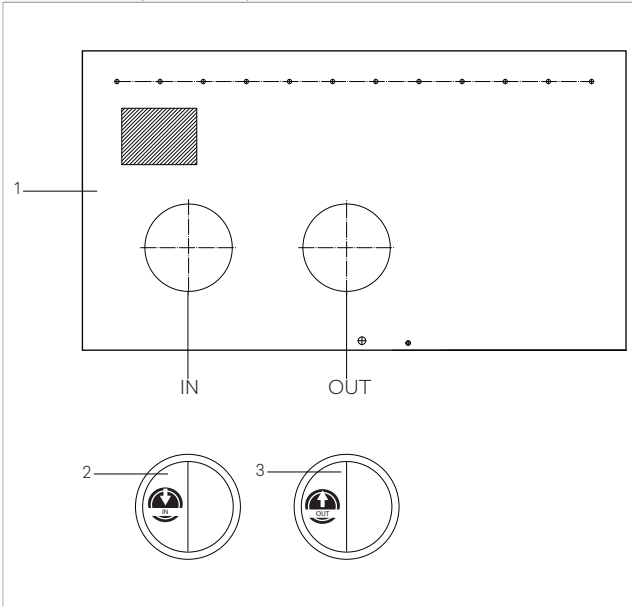

1. Chain
2. Counterflange
3. Spring
4. External air damper

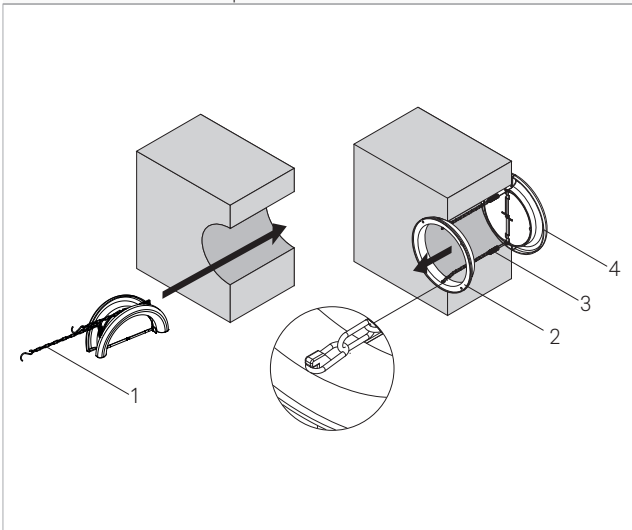

- ▶ fold the damper
- ▶ insert it in the duct until it comes out on the other side of the wall
- ▶ hold the chains with the other hand so that the damper does not fall
- ▶ open the damper outside of the hole
- ▶ rotate the damper so that the flaps are in vertical position
- ▶ insert the counterflange in the hole toward the interior of the room
- ▶ rotate it so that the hooks are in vertical position
- ▶ pull the chains so that the springs are in tension
- ▶ hook the chains to the counterflange
- ▶ cut off the excess of chain

Fixing the bracket

The devices are provided with metallic support for mounting on the wall.

1. Spirit level
2. Metal support
3. Fixing screw
4. Support wall
5. Expansion plug

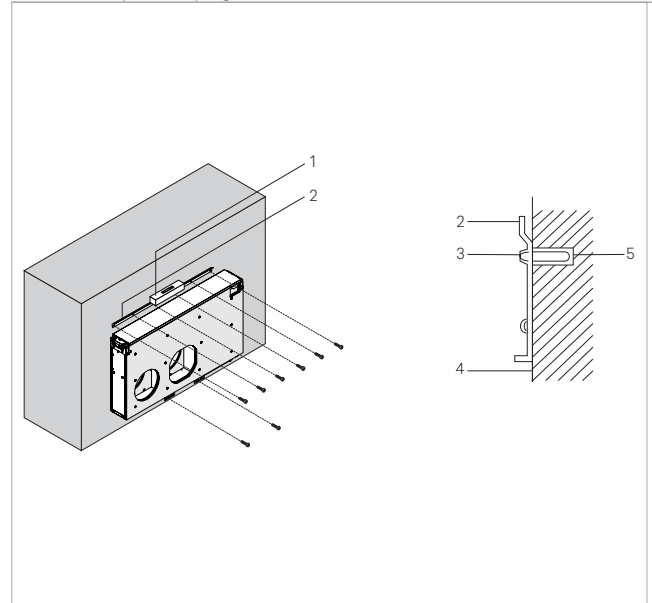

- ▶ use the paper template
- ▶ mark the positions of the fixing holes
- ▶ use a drill
- ▶ drill holes at the marked positions
- ▶ fix the metallic support with the screws and the wall plugs

⚠ Place the metallic support on a level surface that is capable of supporting its weight.

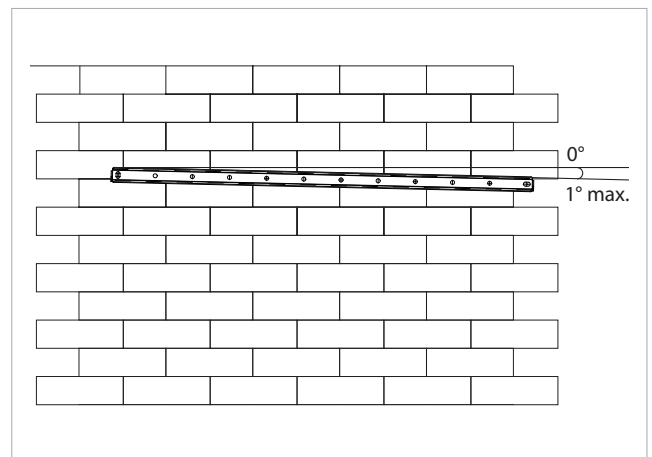

⚠ Check that the installation is horizontal using a water level.

⚠ A maximum inclination of 1° towards the right side of the appliance is allowed to facilitate the drainage of condensate.

Installation

4.11.3 Positioning

1. Interlocking points
2. Metal support

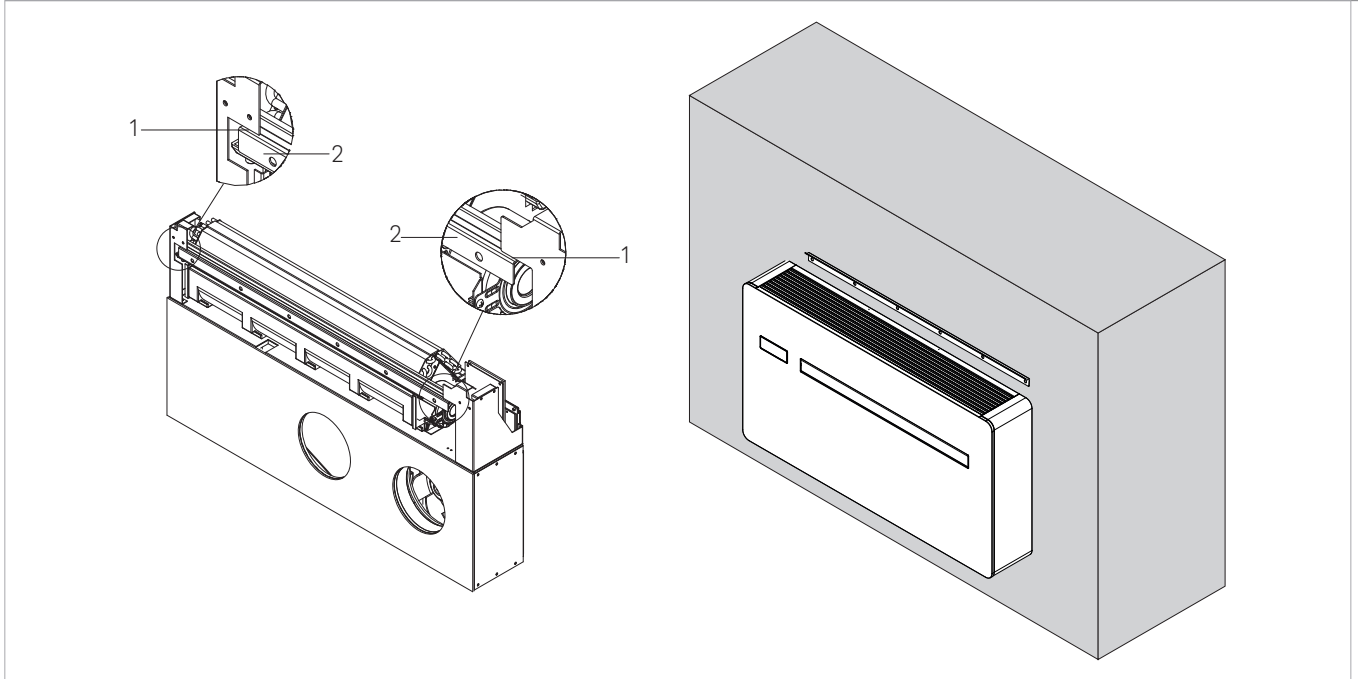

- ▶ fasten the unit to the upper part of the metallic support
- ▶ verify the correct hooking to the interlocking points

⚠ To facilitate connections, a spacer can be used to keep the bottom of the unit away from the wall.

4.12 Condensation drain preparation

This appliance is complete with a tray for collecting the condensation produced during heating, cooling and dehumidification operation.

The size and positioning of the drainage tube are shown below.

In heating operation, condensation should be conveyed to a appropriate place by providing a condensate drain.

In cooling or dehumidification operation, the unit has a system for self-disposal of condensation.

In these modes of operation, an external condensate drain does not need to be provided.

In cooling or dehumidification function, in extreme operating condition (high temperature and high humidity) the unit may not be able to automatically dispose of the produced condensate, in this case the display will show OF.

Refer to the "Maximum condensate collection level warning" *p. 50* section for more details.

4.12.1 Preliminary warnings

- ⚠ Condensate drainage is mandatory when using the appliance in heating mode.
- ⚠ If the line flows into a container (e.g. a tank), do not close the container hermetically and avoid immersing the draining pipe into the water.
- ⚠ The hole for the condensation pipe must always slope towards the outside.
- ⚠ The exact position in which to place the pipe mouth is indicated on the template.
- ⚠ Check that the expelled water does not cause any damage or problems to people or objects. During winter, this water may create sheets of ice outside.
- ⚠ When connecting the condensation drain, be careful not to squeeze the rubber duct.

⚠ It is possible to empty the collection tray using the safety drain at the base of the appliance if necessary.

⚠ If you do not want to prepare an external drainage pipe in "cold only" mode, it is advisable to close the condensate drain with a plug.

4.12.2 Positioning

1. Condensation drain stub
2. Safety drain

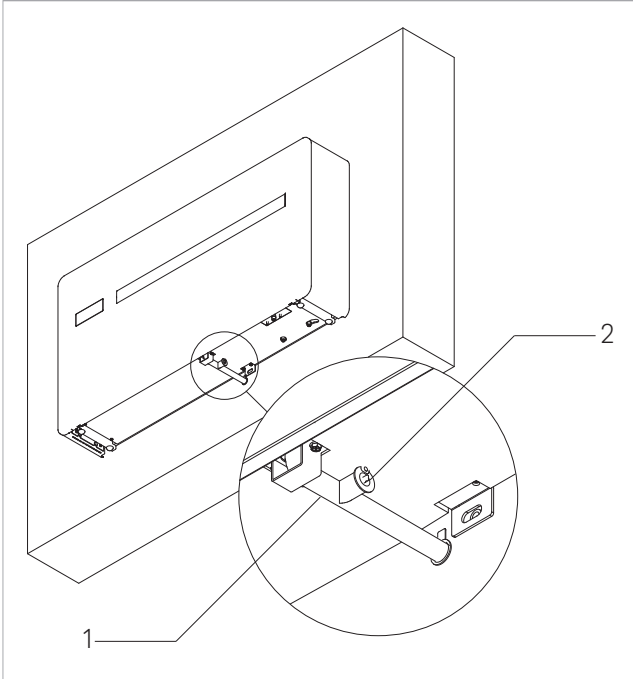

The device is factory supplied with a stub pipe connected to the condensation drain connection. If it is not enough:

- ▶ remove the nozzle from the discharge connection
- ▶ connect a drainage pipe of greater length not supplied
- ▶ keep a minimum slope of 3% towards the drain location
- ▶ insulate fitting points

- ⚠ Use plastic drainage pipes.
- ⚠ Avoid pipes made of metallic material.
- ⚠ Make sure all joints are sealed to prevent leakage of water.
- ⚠ Condensate drainage pipes must be insulated for both indoor and outdoor sections of the house to avoid condensation on the surface and/or freezing problems.
- ⚠ It is possible to empty the collection tray using the safety drain at the base of the appliance if necessary.

If using a jug for collecting the condensation:

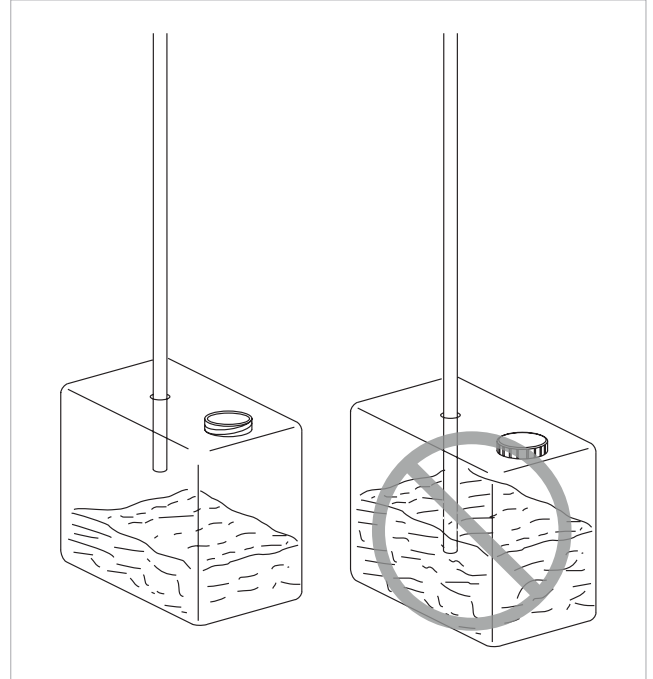

- ⚠ Avoid the hermetic closure of the container.
- ⚠ Prevent the end of the drainage tube from falling below the water level.

If draining into the sewage system:

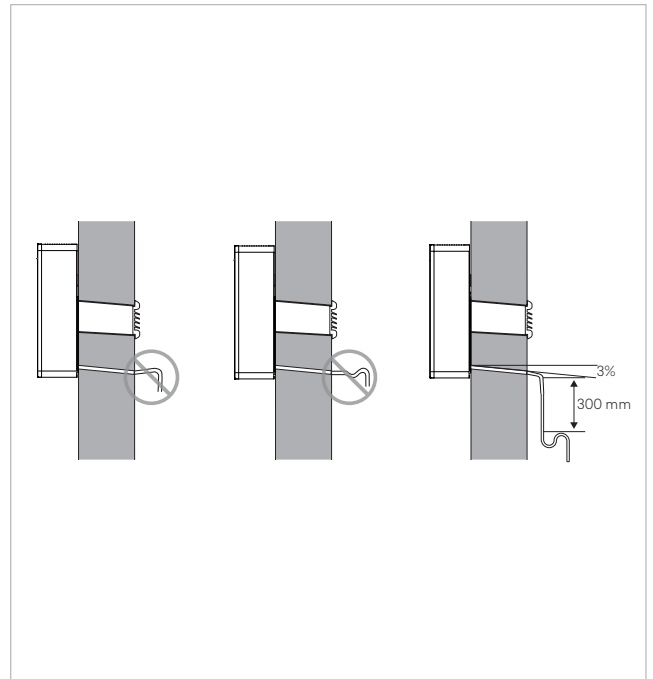

- ⚠ The discharge system must feature a suitable syphon in order to prevent air from entering the vacuum system. The syphon also prevents odours and insects from entering the system.
- ⚠ The syphon must feature a plug in its lower part or must otherwise allow for quick disassembly for cleaning purposes.

Installation

If using an open drain:

- ⚠ If the condensation is not collected, it will be deposited on the support surface. The water could freeze if the outdoor temperatures are below zero, thus creating a hazard. In this case, appropriate barriers should be installed in order to prevent people from approaching the area.

4.13 Electric connections

4.13.1 Preliminary warnings

- ⚠ All operations of an electrical nature must be carried out by qualified personnel having the necessary training, who understands the legal requirements, and is informed about the risks related to such operations.
- ⚠ All connections must be made following the regulations in force in the country of installation.
- ⚠ Before carrying out any work, make sure that the power supply is switched off.
- ⚠ References:
 - refer to the wiring diagrams in this manual for the electrical connections, especially the part concerning the power supply terminal block
- ⚠ Before connecting the conditioner check that:
 - the power supply voltage and frequency values comply with the data plate of the appliance.
 - the line has a suitable earth connection and that it is sized for the maximum absorption of the conditioner (minimum cable section equal to 1,5 mm² and 2,5 mm² for ELEC versions)
 - the socket used is compatible with the plug provided
- ⚠ It is required:
 - provide a suitable earthing connection
 - provide an all-pole switch with a contact opening distance of 3 mm or more that allows complete disconnection under overvoltage category III conditions
 - Install a residual-current device. Failure to install this device may result in electric shock
- ⚠ Use a dedicated power supply circuit. Never use a power supply to which another appliance is also connected because of the risk of overheating, electric shock or fire.
- ⚠ For the electrical connection, use a cable that is long enough to cover the entire distance without any connection. Do not use extension cables. Do not apply other loads on the power supply.
- ⚠ After connecting the interconnection and power cables, make sure that the cables are arranged so as not to exert excessive forces on the covers on the cables. Incomplete connections of the covers may result in overheating of the terminals, electric shock or fire.
- ⚠ Any replacement of the power cable must be carried out by authorised personnel and in accordance with the applicable national law.
- ⚠ The Manufacturer is not liable for any damage caused by the lack of earthing or failure to comply with the specifications in the respective diagrams.

4.12.3 Condensate drain pipe insulation

In case of condensate drain pipe use, the pipe must be coated with anti-condensation insulation for the internal part of the building and the wall.

- ⚠ The insulation must be fitted until the condensate drain pipe is plugged into the connection provided on the unit.

- ⚠ Please check that the power supply is provided with suitable protections against overloads and/or short-circuits (using a 10 Amp Time delay fuse or other equivalent devices is recommended).
- ⚠ To prevent any risk of electrocution, always disconnect the main circuit breaker before making electric connections or performing any maintenance on the units.
- ⚠ Access to the electrical panel is only necessary when replacing the wired cable or when using the presence contact.
- ⊖ It is forbidden the use of gas and water pipes for grounding the appliance.

Preliminary warnings for R32

- ⚠ R32 refrigerant gas is mildly flammable and odourless.
- ⚠ Do not place flammable objects (spray cans) within 1 metre of the air outlet.
- ⚠ All precautions concerning the treatment of the refrigerant must be observed following the regulations in force.
- ⚠ Avoid proximity to sources of ignition in continuous operation (open flames, gas appliances, electric stoves, lighted cigarettes, etc.).
- ⊖ Smoking in the vicinity of the appliance is prohibited.
- ⊖ Using a mobile phone near the appliance is prohibited.
- ⚠ Perform the following checks:
 - carry out safety checks to ensure that the risk of combustion is minimised
 - avoid working in confined spaces
 - delimit the area around the workspace
 - ensure safe working conditions around the area by controlling flammable material

4.13.2 Access to the electrical panel

- | | |
|----|-----------------------|
| 1. | Intake grille |
| 2. | Aesthetic front panel |
| 3. | Control Panel |

- | | |
|----|---------------------------|
| 4. | Connectors |
| 5. | Electrical panel covering |
| 6. | Fixing screws |

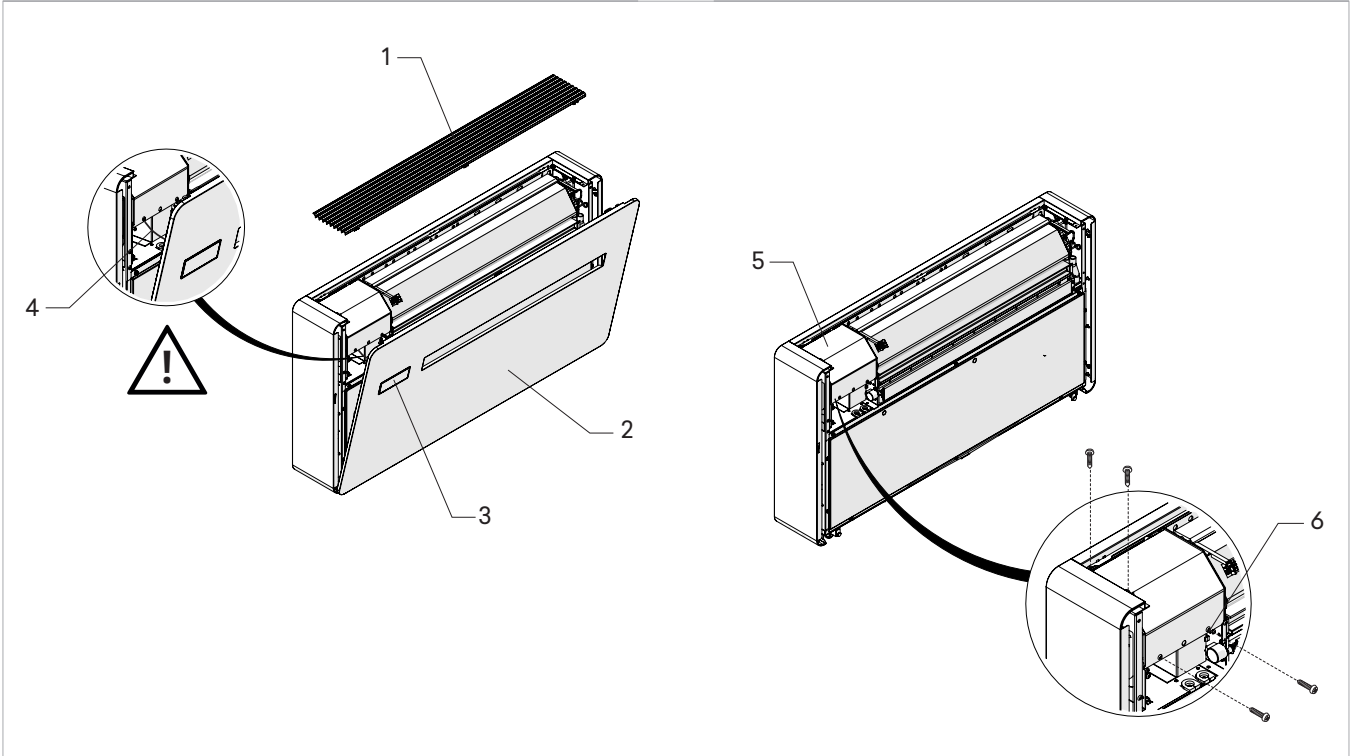

- ⚠ Access to the electrical panel is only permitted to qualified personnel.
- ⚠ Before carrying out any work, please ensure the power supply is disconnected.
- ⚠ The control panel is fixed on the front panel and is connected to the device by a connector.

- ⚠ Disconnect the connector when opening the front panel.

To access:

- ▶ remove the cosmetic panels (if fitted)
- ▶ follow what is indicated in the **"Removal of aesthetic panels and grilles"** p. 27 chapter

To access the connections:

- ▶ unscrew the screws of the electrical panel
- ▶ remove the electrical panel cover

4.13.3 Connection

The appliance leaves the factory fully wired and equipped with a cable with F-type plug for connection to the power supply. To power the unit simply insert the plug into a suitable socket protected by a circuit breaker.

- ⚠ In the event of damage to the power cable, contact the Technical Service Centre or qualified personnel for replacement.

- ⊖ It is forbidden to replace damaged cables yourself.

- | | |
|----|-------------------------------|
| 1. | F-type socket |
| 2. | Plug supplied with the device |

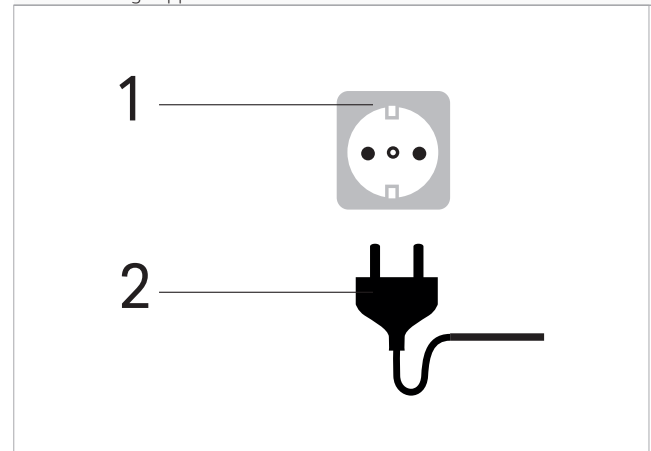

If necessary, it is possible to remove the factory cable with plug and connect the power supply directly to the terminal block (recommended connection for installation of the equipment at the top of the wall).

Installation

PE-IN	Earth connection
ACL-IN	Phase
ACN-IN	Neutral
B A	Serial connection
CP	Presence contact (normally jumpered)

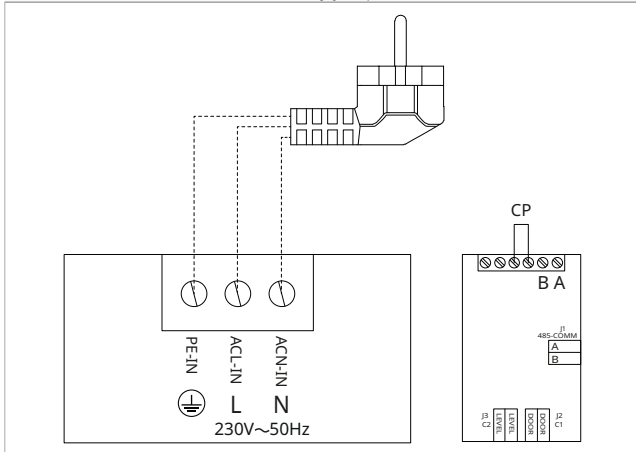

⚠ This operation must be only be carried out by the installation or Technical Assistance Centre.

To carry out direct connections and substitute the power cord using the cable in the wall, proceed as follows:

- ▶ access the terminal block
- ▶ Disconnect the power cord from the terminal block.
- ▶ Connect the wall cable, checking that the power supply line has a suitable earth connection
- ▶ the power supply line has a suitable earth connection and that it is sized for the maximum absorption of the conditioner (minimum cable section equal to 1,5 mm² and 2,5 mm² for ELEC versions)

4.14 High/low installation configuration

The unit can be installed either at the bottom of the wall (adjacent to the floor) or at the top of the wall (adjacent to the ceiling).

The unit is supplied for low wall installation with the air outlet from the bottom to the top.

For high-wall installation:

4.13.4 CP occupancy contact input connection

When the CP contact opens (very low voltage, connected to a volt-free contact) the appliance is put in stand-by and CP appears on the display.

Through this contact it is possible to connect an external device that inhibits operation of the unit such as: window opening contact, remote on/off, infrared presence sensor, activation badge etc.

⚠ We recommend using a double insulated cable.

⚠ For the ELEC versions with resistor, disconnecting voltage from the device abruptly is prohibited in order to prevent internal overheating! Use the CP contact that places the device in standby and guarantees correct post-ventilation.

CP	Presence contact (normally jumpered)
B A	Serial connection

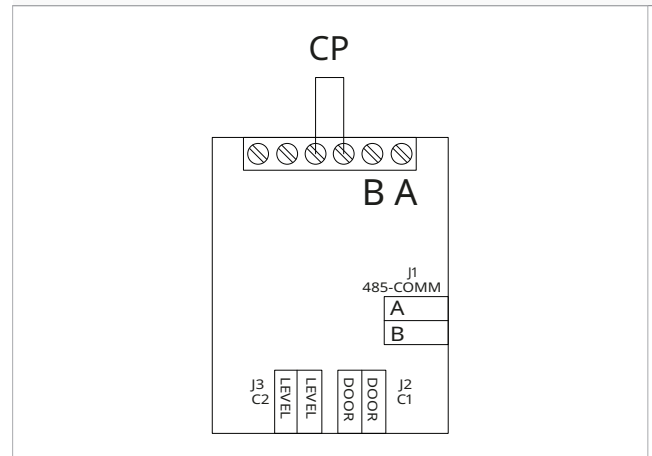

4.14.1 Changing air flow direction

⚠ If necessary, the air outlet can be changed from top to bottom.

⚠ This operation must be performed while the appliance is switched off and disconnected.

To make changes:

- ▶ if installed, remove aesthetic panels see chapter "Removal of aesthetic panels and grilles" *p. 27*
- ▶ Position the lower aesthetic cover kit (code GB0737II).
- ▶ fix with the screws provided
- ▶ remove the fixing screws of the right flap support bracket
- ▶ turn the right flap support bracket 180°
- ▶ reassemble the right flap support bracket
- ▶ reassemble the aesthetic panel
- ▶ re-install the grille
- ▶ see the chapter "Assembly of aesthetic panels and grilles" *p. 29*

- ▶ purchase the aesthetic lower cover kit

⚠ High wall installation is recommended if the unit is to be used for cooling only.

⚠ If the unit operates in cooling and heating or heating only, low wall installation is recommended.

A	Overhead installation	2.	Fixing screws (supplied with the optional kit GB0737II)
B	Low installation (factory settings)	3.	Right support bracket for the flap
1.	Aesthetic lower cover kit (Code GB0737II)		

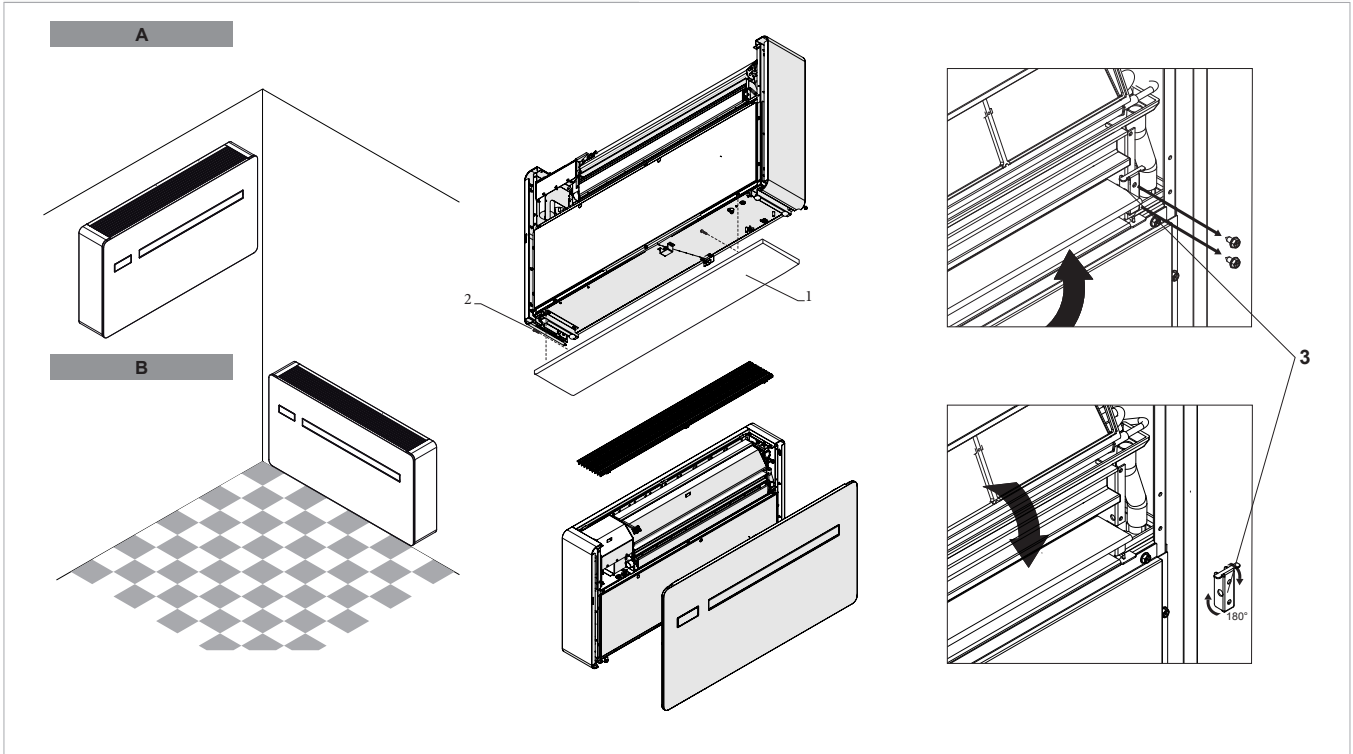

4.14.2 Configuration

After completing the mechanical operations of changing the position of the mobile air outlet deflector, it is necessary to configure the unit's control electronics.

To configure

▶ refer to chapter "Installation position" *p. 32*

⚠ For the appliance to work properly, each time the configuration of the air outlet flap is modified, the electronic control must be set.

4.15 Operations after installation

Before leaving the site, the packaging should be gathered up and all traces of dirt that have deposited on the unit during assembly should be eliminated with a damp cloth. Once all the checks and controls on the correct operation of the appliance have been completed, the installer must explain the following to the user:

- the basic characteristics of the appliance
- the instructions for use
- the routine maintenance

4.16 Removal of aesthetic panels and grilles

⚠ The control panel is fixed on the front panel and is connected to the device by a connector.

⚠ Disconnect the connector when opening the front panel.

- ▶ remove the upper grille
- ▶ remove the filter
- ▶ unscrew the fixing screws of the aesthetic panel
- ▶ disconnect the connector of the on-board control
- ▶ remove the aesthetic panel
- ▶ unscrew the fixing screws of the side panel
- ▶ remove the side panel

Installation

1. Intake grille
2. Filter
3. Control Panel

4. Connectors
5. Aesthetic front panel
6. Side panel

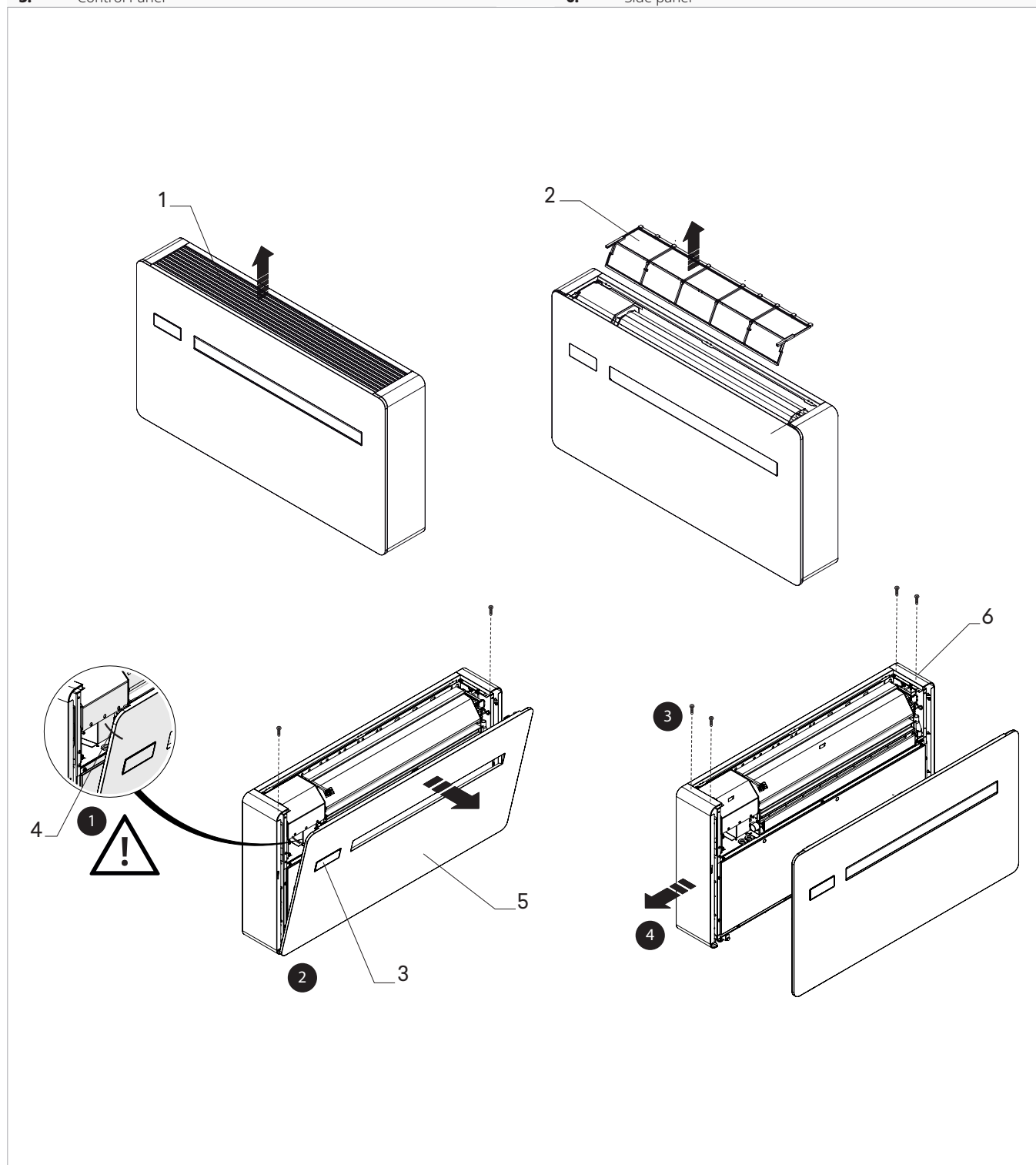

4.17 Assembly of aesthetic panels and grilles

- ▶ place the side panel
- ▶ screw in the fixing screws
- ▶ positioning the aesthetic panel
- ▶ connect the connector of the on-board control
- ▶ screw in the fixing screws
- ▶ place the filter
- ▶ positioning the grill

1.	Side panel
2.	Aesthetic front panel
3.	Connectors

4.	Control Panel
5.	Filter
6.	Intake grille

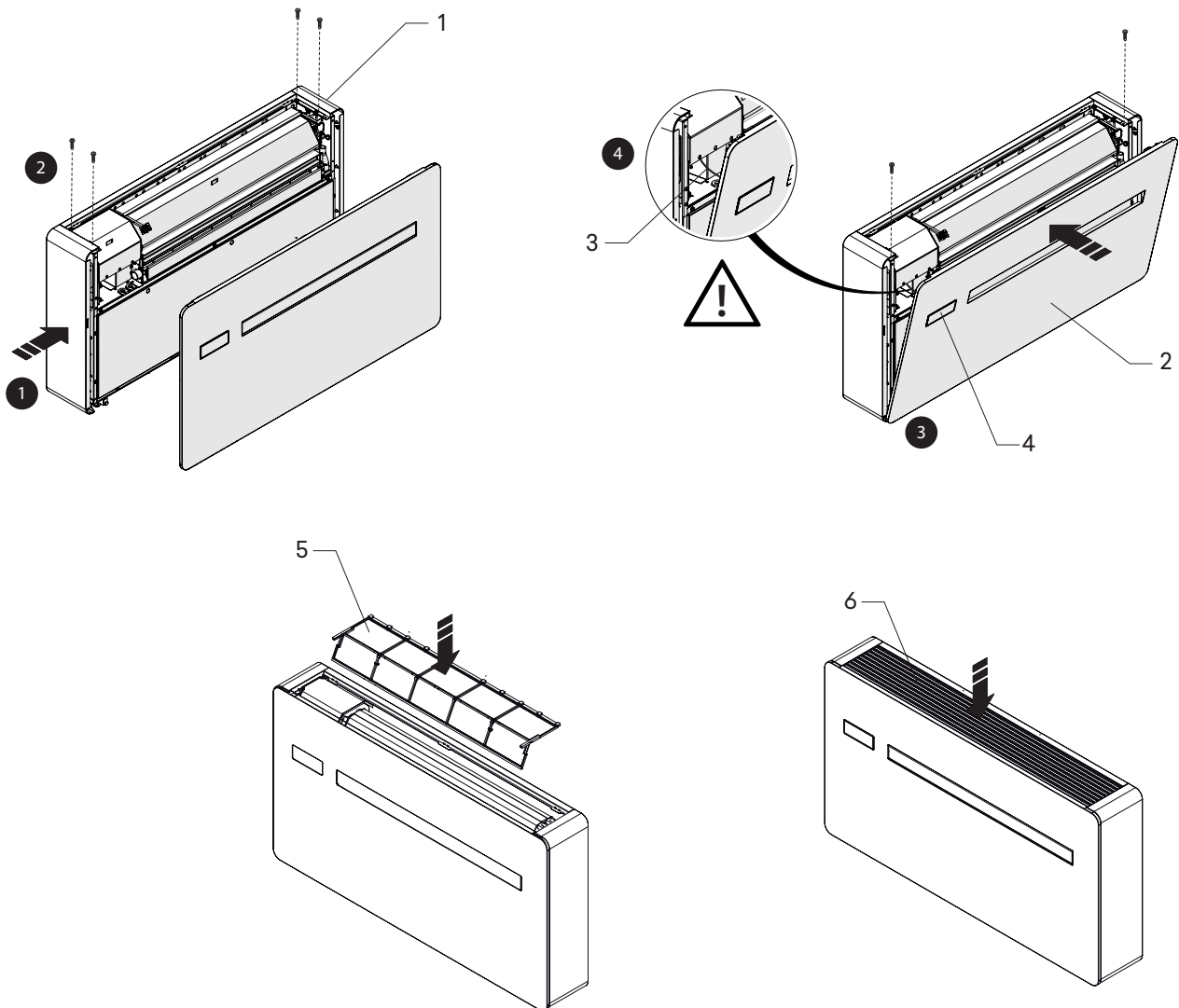

5. TOUCHPAD AND REMOTE CONTROL

5.1 Interface

5.1.1 Description

The touchpad control is supplied as standard on board the unit, does not require any connections and enables:

- show the operating status
- show any alarms
- select the various functions

5.1.2 Touchpad

Keys and functions related.

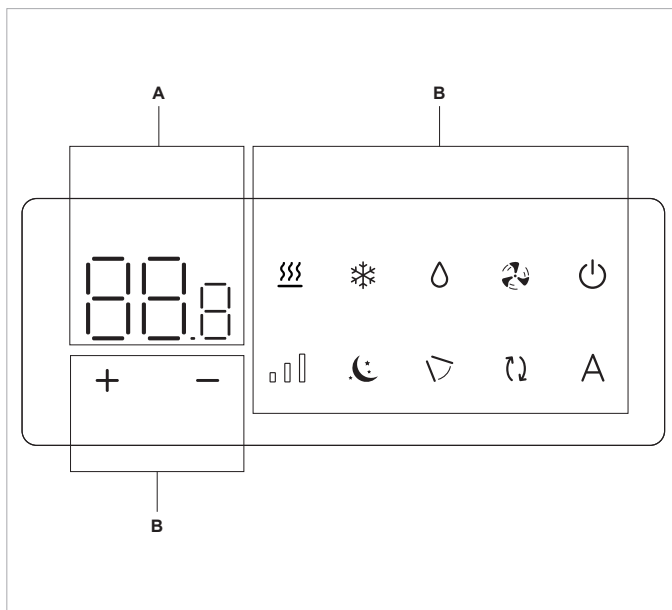

A	Display area
B	Keys area
	Setpoint
	Up key
	Down key
	Allows you to select the Heating mode of operation
	Allows you to select the Cooling mode of operation
	Allows you to activate the Dehumidification function
	Allows you to activate the Ventilation function
	This can be used to switch the unit on or off
	Allows you to control ventilation speed
	Enables the Night function
	Allows you to activate the Moving Deflector Control function
	Allows you to activate the Air Change function (not visible on base unit)
	Enables the Automatic function

5.2 Basic menu

To access the basic menu

- ▶ press for 10 seconds
Appears .

To move within the menu or change values

- ▶ use

To select a menu item and to confirm the changes made

- ▶ press
The menu item is selected and the settings are accessed.
Changes are confirmed when the symbol appears.

To exit menu items without saving

- ▶ press
You exit the selected menu item.

To exit the basic menu

- ▶ press once
Appears --.

- ▶ press again
You exit the basic menu.

After a period of 30 seconds from the last action, the display turns off.

5.2.1 Menu items

Ub: Buzzer volume

uP: Wi-Fi pairing

ur: Wi-Fi reset

Ht: Heating element type configuration (only for models Vision 3.1 ELEC 2 kW)

oH: Temperature offset in Heating

oC: Temperature offset in Cooling

CF: Scale

5.2.2 Buzzer volume

To change the volume

- ▶ select the volume setting range is from 0 (min) to 3 (max).

⚠ The volume changes after change is confirmed.

5.2.3 Activate Wi-Fi

To activate Wi-Fi

- ▶ select
- ▶ press to change settings
- ▶ use the icons in sequence
Appears
- ▶ press
- ▶ appears to enable Wi-Fi pairing.
- ▶ press to confirm

⚠ The device remains visible on the App for the first 15 minutes after the device is switched on.

5.2.4 Wi-Fi reset

To reset the Wi-Fi credentials and return the device to its original configuration

- ▶ select
- ▶ press to change settings
- ▶ use the icons in sequence
Appears
- ▶ press
- ▶ appears to reset Wi-Fi credentials.
- ▶ press to confirm
Credentials have been reset.

5.2.5 Heating element type configuration

⚠ This setting is only visible in the basic menu for Vision 3.1 Elec models.

To configure the heating element type

- ▶ select
- ▶ select NO to disable the heating element
- ▶ select r1 to configure the heating element to 1 kW
- ▶ select r2 to configure the heating element to 2 kW
By default the device is set to r1.

5.2.6 Temperature offset in Heating

To set the temperature offset in Heating

- ▶ select
- The temperature offset setting range in Heating is from -9 °C (minimum) to 9 °C (maximum).*

⚠ The range for °F is smaller, equivalent to -5 °C/5 °C.

5.2.7 Temperature offset in Cooling

To set the temperature offset in Cooling

- ▶ select
- The temperature offset setting range in Cooling is from -9 °C (minimum) to 9 °C (maximum).*

⚠ The range for °F is smaller, equivalent to -5 °C/5 °C.

5.2.8 Scale

To change the temperature unit of measure

- ▶ select
- ▶ select °C or °F
By default the temperature unit of measure is °C.

5.3 Advanced Menu

Through the control panel, it is possible to access the advanced menu.

⚠ To access the advanced menu, it is first necessary to access the basic menu. See section "Basic menu" p. 30.

To access the advanced menu

- ▶ from the basic menu press at the same time for about 5 seconds
Appears
The advanced menu is accessed.

To move within the menu or change values

- ▶ use

To select a menu item and to confirm the changes made

- ▶ press
The menu item is selected and the settings are accessed.
Changes are confirmed when the symbol appears.

To exit menu items without saving

- ▶ press
You exit the selected menu item.

To exit the settings menu

- ▶ press
Appears
You return to the basic menu.

⚠ After a period of 30 seconds from the last action, the display turns off.

5.3.1 Menu items

HC: Heating only or Cooling only configuration

ho: Hotel Mode

in: Installation position

Ad: Modbus address

rF: Remote function

co: Connectivity expansion module

Controls

HE: Heating element operation mode configuration (only for models with electric heating element)

Uu: UV lamp activation (only for models with UV lamp accessory)

Hr: Not used

HL: Configuration minimum temperature limit in heating.

Hh: Configuration of maximum temperature limit in heating mode.

CL: Configuration minimum temperature limit in cooling.

Ch: Configuration maximum temperature limit in cooling.

5.3.2 Heating only or Cooling only configuration

⚠ It is possible to disable the Heating or Cooling function by setting the unit in Heating only or Cooling only mode.

To set the Heating only or Cooling only mode

- ▶ select $\overline{H|C}$
 - ▶ select hc to set the Heating and Cooling mode
 - ▶ select ho to set the Heating only mode
 - ▶ select co to set the Cooling only mode
- By default, the unit is set to Hc.*

5.3.3 Hotel Mode

To set the Hotel mode

- ▶ select $\overline{H|C}$
 - ▶ select YS to turn on Hotel mode
 - ▶ select NO to turn off the Hotel mode
- By default the device is set to NO.*

Activating the Hotel mode:

- the Dehumidification Only and Automatic functions are deactivated
- only the Ventilation Only, Heating and Cooling functions remain active
- the temperature setting range is reduced, in Cooling you can set from 22 °C to 28 °C, in Heating you can set from 16 °C to 24 °C

5.3.4 Installation position

After completing the mechanical operations of changing the air outlet flap position, it is necessary to configure the unit.

To configure the installation position

- ▶ select $\overline{I|N}$
 - ▶ select dn to set up installation at the bottom of the device
 - ▶ select uP to set the top installation of the unit
- By default, the unit is set to dn.*

⚠ For the appliance to work properly, each time the configuration of the air outlet flap is modified, the electronic control must be set.

5.3.5 Modbus address

To set the Modbus address

- ▶ select $\overline{R|D}$
 - ▶ act on $\overline{+|-}$
- the setting range is from 1 (min) to 99 (max).
By default the device is set to 1.*

5.3.6 Remote function

To set the Remote function

- ▶ select $\overline{R|F}$
 - ▶ select no to disable the Remote function
 - ▶ select YS to enable Remote function
- By default, the device is set to no.*

⚠ Set the remote mode to make the touchpad view only.

5.3.7 Connectivity expansion module

To enable or disable the connectivity expansion module

- ▶ select $\overline{C|E}$
 - ▶ select YS to activate the connectivity expansion module
 - ▶ select no to disable the connectivity expansion module
- By default, the appliance is set to YS.*

⚠ In case of pairing with a wall control of the M7 series, it is mandatory to disable the connectivity expansion module.

5.3.8 Heating element operation mode configuration

⚠ Use only for models with heating element.

To configure the operation mode of the heating element

- ▶ select $\overline{H|E}$
 - ▶ select rE for combined heat pump and heating element operation
 - ▶ select rH for heating element-only operation (Heating only)
 - ▶ select rt for alternating operation
 - with external temperature > -10 °C, combined operation of heat pump and resistance is activated
 - with external temperature < -10 °C, operation with only resistance is activated
- By default, the unit equipped with electric resistance is set to rE.*

5.3.9 UV lamp activation

⚠ Use only for models with UV lamp accessory installed.

To enable the UV lamp

- ▶ select $\overline{U|V}$
 - ▶ select NO to disable UV lamp
 - ▶ select YS to enable UV lamp
- By default, the unit equipped with the UV lamp accessory is set to YS.*

5.3.10 Set the minimum temperature limit in heating

⚠ The function can only be activated with $\text{H}\square$ active.

To set the minimum temperature limit in heating

- ▶ select $\text{H}\square$
- ▶ act on $\text{H}\square$

The setting range is from a minimum of 16 to Hh-1.
The setting range is from a minimum of 16 to Hh-1.
By default it is set to 16 °C.

⚠ Between HL and Hh the set value varies by 1 °C.

5.3.11 Set the maximum temperature limit in heating

⚠ The function can only be activated with $\text{H}\square$ active.

To set the maximum temperature limit in heating

- ▶ select $\text{H}\square$
- ▶ act on $\text{H}\square$

The setting range is from a minimum of HL+1 to 31.
By default it is set to 24 °C.

⚠ Between HL and Hh the set value varies by 1 °C.

5.3.12 Set the minimum temperature limit in cooling

⚠ The function can only be activated with $\text{H}\square$ active.

To set the minimum temperature limit in cooling

- ▶ select $\text{H}\square$
- ▶ act on $\text{H}\square$

The setting range is from a minimum of 16 to Ch-1.
By default it is set to 22 °C.

⚠ Between CL and Ch the set value varies by 1 °C.

5.3.13 Set the maximum temperature limit in cooling

⚠ The function can only be activated with $\text{H}\square$ active.

To set the maximum temperature limit in cooling

- ▶ select $\text{H}\square$
- ▶ act on $\text{H}\square$

The setting range is from a minimum of CL+1 to 31.
By default it is set to 28 °C.

⚠ Between CL and Ch the set value varies by 1 °C.

5.4 Visualisation of alarms on display

⚠ In the event of an alarm, the device still maintains active functions.

⚠ A flashing $\text{H}\square$ symbol and alarm code are displayed on the touchpad to indicate alarms.

Code	Alarm description
Er01	Room temperature probe error (RT)
Er02	Error of the temperature sensor of the internal heat exchanger (IPT)
Er03	Error outdoor air temperature probe (OT)
Er04	Error of the external heat exchanger temperature probe (OPT)
Er05	Malfunctioning of the internal fan
Er06	Malfunction of the external fan
Er07	Driver communication error
Er08	Compressor discharge temperature probe (TD) error
Er09	Communication error with remote thermostat M7
Er10	Maximum level float intervention in the condensate drip tray (ALARM)
CP	Open (CP) contact
Er12	Driver error - compressor failure
CE	Communication error between main circuit board and display
Er16	4-way valve management error or alarm for insufficient refrigerant charge
Er17	Driver parameter error or compressor incompatibility
Er19	Heating element safety temperature probe error (LEVEL)
Er20	Error of the second temperature probe of the external heat exchanger (GT)

Code	Alarm description
Er22	Wrong power supply
Er23	UV lamp kit error
Er24	ERV kit error
BL	Key lock

6. M7 SERIES CONTROL EEB749

6.1 Interface

6.1.1 Description

M7 series LED electronic control panels with touch interface for wall installation allow:

- room temperature control
- management of the main functions of the device
- temperature and humidity measurement
- fan speed regulation

They are fitted with:

- internal memory with data saving even in case of shut-down or power outage

⚠ After 20 seconds after the last action the panel brightness is reduced, only the room temperature is seen on the display.

⚠ The maximum brightness is restored to the pressure of any key.

⚠ **It is mandatory to disable the connectivity expansion module (Wi-Fi) from the Touchpad. See paragraph "Connectivity expansion module" p. 32. In case of using the app to control the unit, it must be paired with a wall control of the M series / code EFB749.**

6.1.2 Display

Status and active alarms on display.

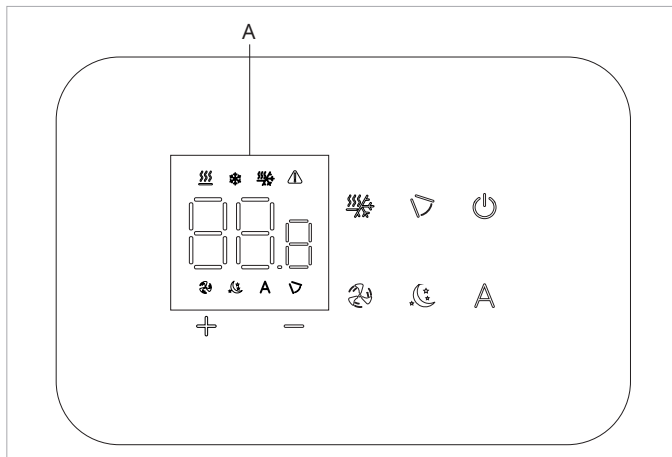

A	Display area
BBB	Setpoint
⚠	Alarm signals
▽	Moving Deflector Control function active
🌀	Active ventilation function
🔥	Heating / Cooling (Cannot be used)
❄️	Cooling operating mode active
🔥	Heating operating mode active
⏸	Automatic function active
🌙	Night function active

6.1.3 Keys functions

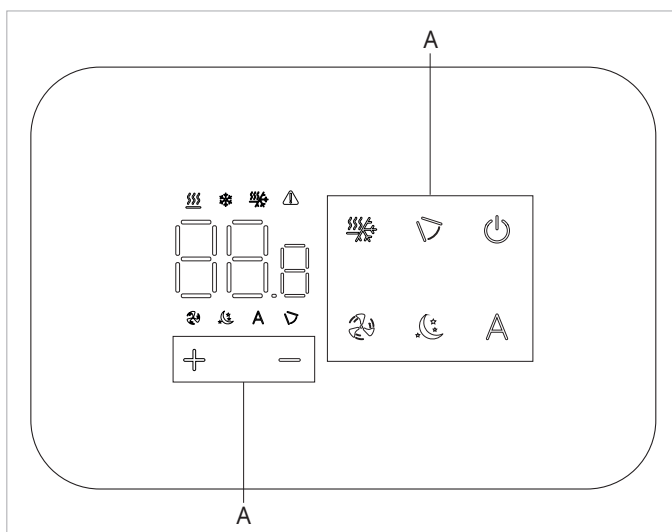

A	Keys area
+	Up key
-	Down key
🔌	This can be used to switch the unit on or off
▽	Allows you to activate the Moving Deflector Control function
🌀	Allows you to control ventilation speed
🔥/❄️	This can be used to select the operating mode (Cooling or Heating) or Autochangeover
⏸	Enables the Automatic function
🌙	Enables the Night function

6.2 Installation

6.2.1 Description

The wall-mounted remote control is an electronic LED thermostat with a touch interface, with the possibility of controlling multiple appliances equipped with the same electronic board. It is equipped with a temperature and humidity probe.

⚠ The control can manage a maximum of 16 units.

6.2.2 Mounting

⚠ The control panel for wall control is to be installed inside a 503 electrical box.

⚠ A wall must be prepared to accommodate the 503 electrical box before installing the wall control.

⚠ Ensure that:

- the wall supports the weight of the appliance
- the section of the wall does not contain piping or electrical lines
- the functionality of load-bearing elements is not compromised

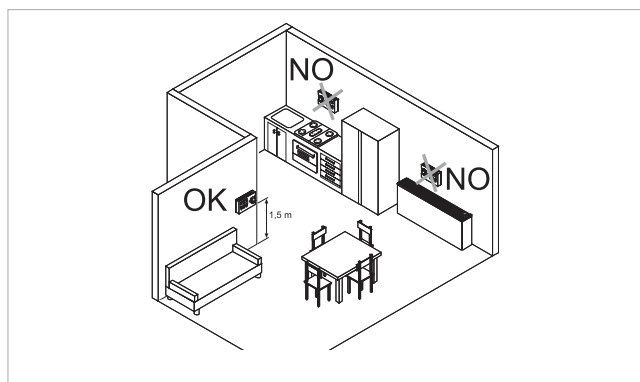

The wall-mounted remote control must be installed:

- on internal walls
- at a height of about 1,5 m from the floor

⚠ Should the control be located in an area utilised by persons with reduced physical capabilities, please refer to local regulations.

- away from doors or windows
- away from heat sources (heaters, convectors, stoves, direct sunlight)

⚠ The wall control is provided inside the package already assembled.

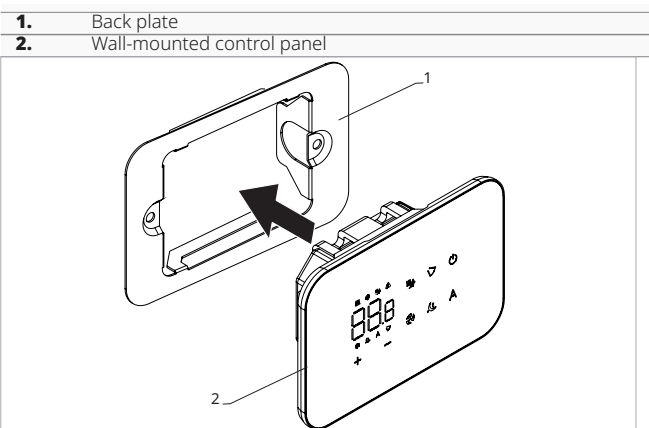

Before wall installation:

- ▶ separate the back plate from the control panel

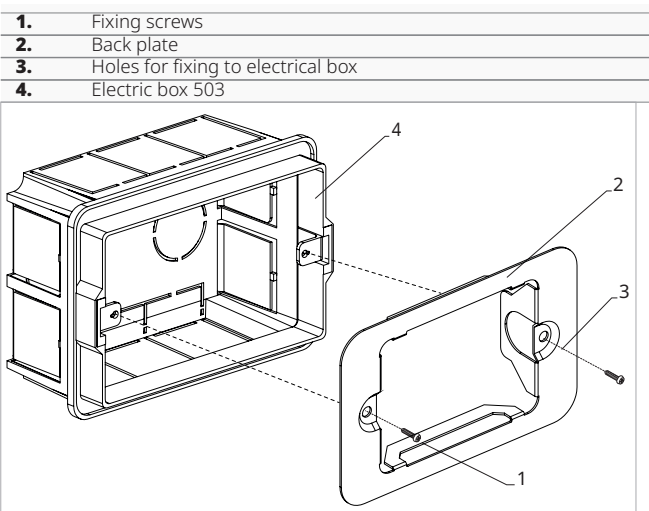

For wall mounting of the control panel:

- ▶ fix the control base to the electrical box 503 with screws
- ▶ connect the electrical wiring

⚠ Before making the connections, please verify that the control terminal block is on the right-hand side.

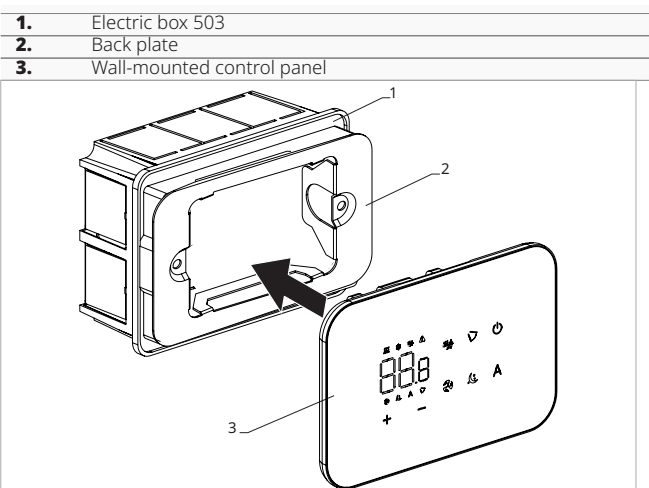

- ▶ Close the control panel

Controls

⚠ Pay attention not to crush the conductors when you close the control.

6.3 Single connection diagram

1.	M7 series wall control panel	BA	Serial connection for wall-mounted remote control
2.	Terminal block for device connection	--+	12 V-DC 1A power supply
CP	Presence contact (normally open)	M7	Command for wall control M7

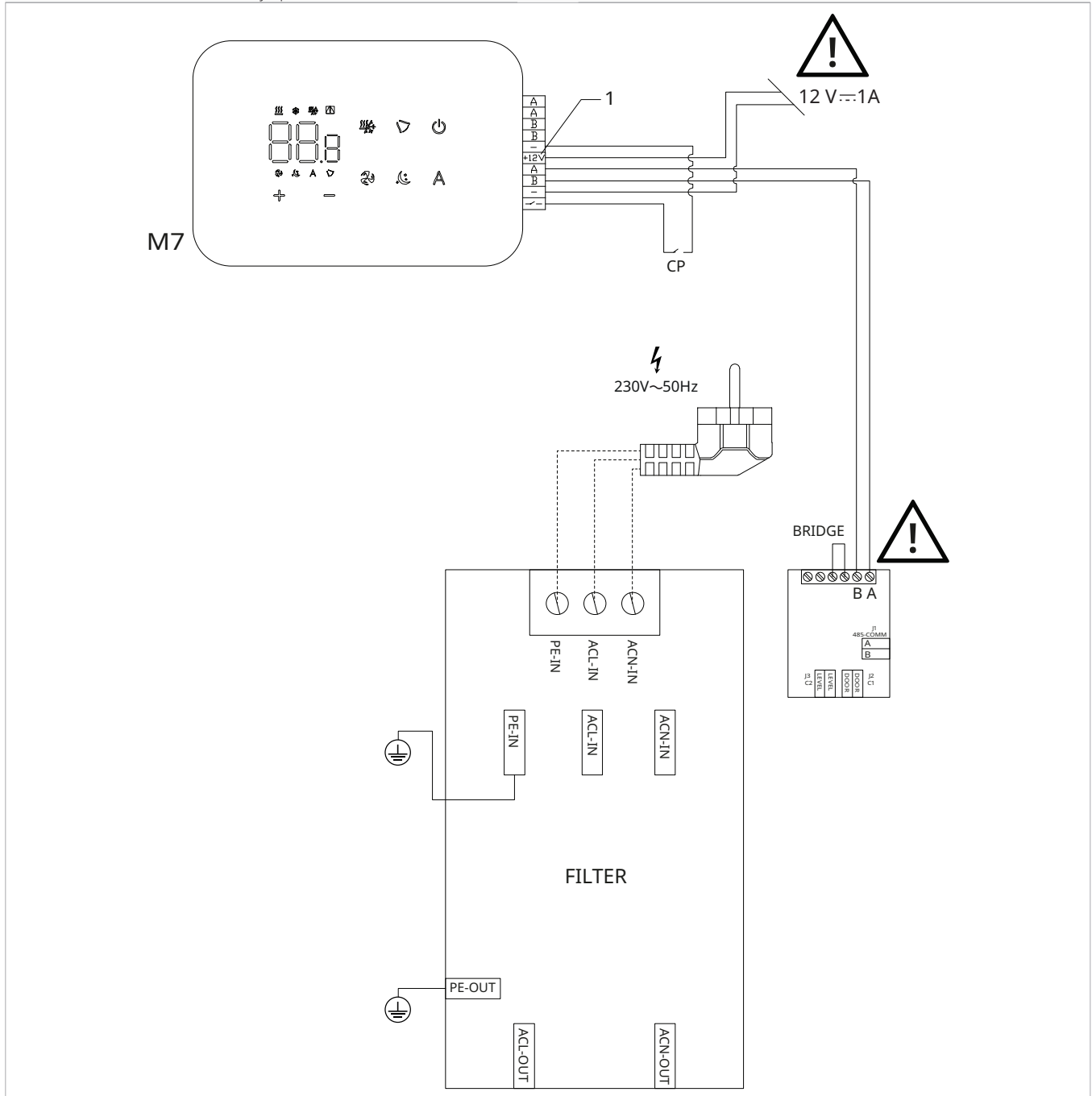

⚠ Reverse A and B for connecting the wall control panel with the board.

⚠ Power for the control is to be supplied through a 12 V-DC 1A power supply (not field supplied).

6.4 Connections

6.4.1 Preliminary warnings

The terminals accept:

- rigid or flexible wires with a 0.2 to 1 mm² cross-section
- rigid or flexible wires with 0,5 mm² cross-section if two wires are connected to the same terminal block
- rigid or flexible wires with 0,75 mm² cross-section If the wires have wire end ferrules with a plastic collar

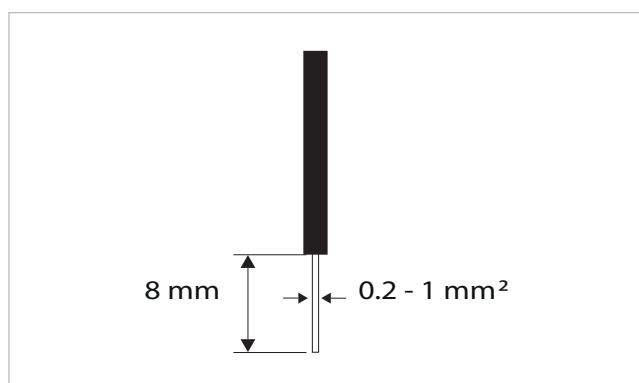

To connect the cables:

- ▶ strip 8 mm of the wire
- ▶ if the wire is rigid, you can insert it easily whereas
- ▶ if it is flexible, use appropriate crimp terminals
- ▶ push the wire in completely
- ▶ check the right fixing by pulling it gently

6.4.2 Control Panel

⚠ The control panel for wall control must be ordered separately.

Terminal block position:

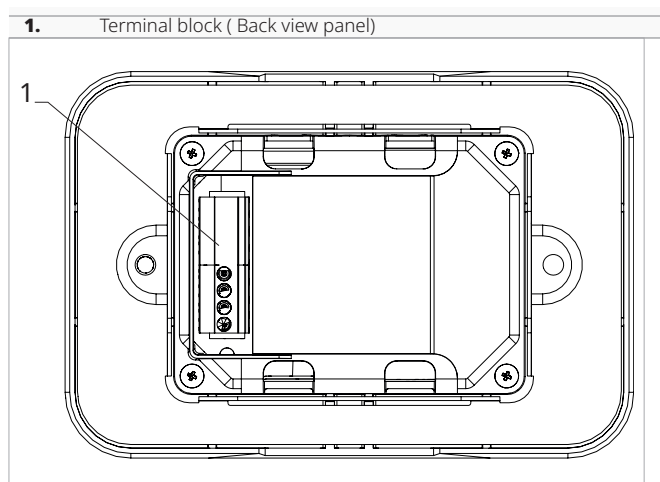

6.5 Basic menu

To access the basic menu

- ▶ with the display off, hold down  for 10 seconds

The device turns on and  appears

To make the connections:

- ▶ connect the + - power supply wires to a 12 V-DC 1A power supply
- ▶ connect the ModBus serial connection cables to terminals A and B

⚠ Reverse A and B for connecting the wall control panel with the board.

6.4.3 Presence contact CP

Through this device it is possible to connect an external control signal that inhibits the operation of the control signal, for example:

- opening window contact
- remote on/off
- infrared presence sensor
- activation badge
- remote change of season

Function

The contact is normally open (NO).

- ▶ when closing the CP contact, connected to a potential-free contact, the device switches to standby mode
- ▶ *CP appears on the display.*
- ▶ At the touch of a button on the display the symbol  flashes.

⊖ It is forbidden to connect the CP input to that of another unit electronic board. Use separate contacts.

6.4.4 Extended display

⚠ To enable device connectivity and enable selection of fan power level, the display must be extended. See section "Extended display" p. 39.

Controls

To navigate in the menu

- ▶ use the icons 

To select a menu item and to confirm the changes made

- ▶ press the icon 
Confirming the change takes you to the next item.

To exit the menu

- ▶ press the icon  for 10 seconds
- ▶ or wait 30 seconds the automatic shutdown

 After a period of 30 seconds from the last action, the display turns off.

6.5.1 Menu items

ot: AIR probe offset (air probe setting)

ur: Value read by the R.H. sensor

ut: Probe Offset PT4

uS: Humidity setpoint

uI: Humidity hysteresis

CF: Scale

ub: Buzzer volume





uu: Not used

uP: Not used

ho: Hotel Mode

6.5.2 Set AIR probe offset





To set the air probe offset

- ▶ select 
- ▶ press  to change settings
- ▶ increase or decrease the value with the icons 
- ▶ press  to confirm
*By default it is set to -2,5°C.
The setting range is from a minimum of -12.0 °C to a maximum of 12.0 °C.*

6.5.3 Set probe offset RH





 Modify only after real deviations from an actual measurement has been established with professional equipment.

To set the RH probe offset

- ▶ select 
- ▶ press  to change settings
- ▶ increase or decrease the value with the icons 
- ▶ press  to confirm
By default it is set to -2.





6.5.4 Set the humidity setpoint

To set the humidity setpoint

- ▶ select 
- ▶ press  to change settings
- ▶ increase or decrease the value with the icons 
- ▶ press  to confirm
*By default it is set to 50.
The setting range is from 20.0% to 90.0%.*



6.5.5 Setting the humidity hysteresis

To set the humidity hysteresis

- ▶ select 
- ▶ press  to change settings
- ▶ increase or decrease the value with the icons 
- ▶ press  to confirm
*By default it is set to 5.
The setting range is from 1 (min) to 30 (max).*





6.5.6 Scale

To change the temperature unit of measure

- ▶ select 
- ▶ press  to change settings
- ▶ select °C or °F
- ▶ press  to confirm
By default the temperature unit of measure is ° C.

6.5.7 Adjusting the volume

To change the volume

- ▶ select 
- ▶ press  to change settings
- ▶ increase or decrease the value with the icons 
- ▶ press  to confirm
*By default it is set to 1.
The volume setting range is from 00 (min) to 03 (max).*

 The volume changes after confirming the modification.

6.5.8 Setting the Hotel Mode

To set the Hotel mode

- ▶ select 
- ▶ select YS to turn on Hotel mode
- ▶ select NO to turn off the Hotel mode
By default the device is set to NO.

Activating the Hotel mode:





- the Autochangeover function is deactivated
- the temperature setting range is reduced, in Cooling you can set from 22 °C to 28 °C, in Heating you can set from 16 °C to 24 °C

6.6 Advanced Menu



Through the control panel, it is possible to access the advanced menu.

⚠ To access the advanced menu, it is first necessary to access the basic menu. See section "Basic menu" p. 37.

To access the advanced menu

- ▶ from the basic menu press **A**
Appears 
- ▶ press the  key once
Appears 
- ▶ press  to confirm and log in
The advanced menu is accessed.



To navigate in the menu

- ▶ use the icons  

To select a menu item and to confirm the changes made

- ▶ press  for 2 seconds
Confirming the change takes you to the next item.

To exit the menu

- ▶ press  for about 10 seconds
Appears 
- ▶ press  for about 10 seconds
The display turns off.
- ▶ or wait 30 seconds after the last action
The display is switched off automatically.

⚠ After a period of 30 seconds from the last action, the display turns off.

6.6.1 Menu items

Ad: Not used

Pr: Not used

di: Options for digital input

t1: Not used

rH: Not used

rC: Not used

UC: Not used

Ac: Not used

Ah: Not used



Ed: Extended display

Ab: Enabling brightness sensor

Fr: Not used

6.6.2 To select digital input

To change the digital input

- ▶ select 
- ▶ press  to change settings
- ▶ select CP for presence contact (default)
- ▶ select CO to cooling open
- ▶ select CC to cooling close
- ▶ press  to confirm
By default digital input is set to CP.

⚠ For return to the default settings, set the digital input to "CP".

⚠ By selecting one of the other inputs (CO,CC) the seasonality is locked. It is not possible to modify it through the key  of the control.

6.6.3 Extended display

⚠ Allows device connectivity and enables the selection of the ventilation power level.

⚠ To use the ventilation speed selection, it is necessary to enable the display extension.





To enable the display extension

- ▶ select 
- ▶ select no to disable
- ▶ select Ys to enable
By default, the device is set to no.

6.6.4 Optical sensor

⚠ By default, the brightness sensor is set.

To disable the brightness sensor:

- ▶ select 
- ▶ press 
Appear Ys.
- ▶ press 
- ▶ select no
- ▶ press  to confirm
The brightness sensor is disabled.

⚠ The brightness sensor adapts to room lighting.

6.7 Alarm display on wall control panel

⚠ In the event of an alarm, the device still maintains active functions.

⚠ Alarm codes are shown on the on-board display. Refer to the "Visualisation of alarms on display" p. 33 chapter for the complete list.

7. M7 SERIES COMMANDS EFB749

7.1 Interface

7.1.1 Description

M7 series LED electronic control panels with touch interface for wall installation allow:

- room temperature control
- management of the main functions of the device
- temperature and humidity measurement
- fan speed regulation

They are fitted with:

- internal memory with data saving even in case of shut-down or power outage

⚠ After 20 seconds after the last action the panel brightness is reduced, only the room temperature is seen on the display.

⚠ The maximum brightness is restored to the pressure of any key.

⚠ **It is mandatory to disable the connectivity expansion module (Wi-Fi) from the Touchpad. See paragraph "Connectivity expansion module" p. 32.**

7.1.2 Display

Status and active alarms on display.

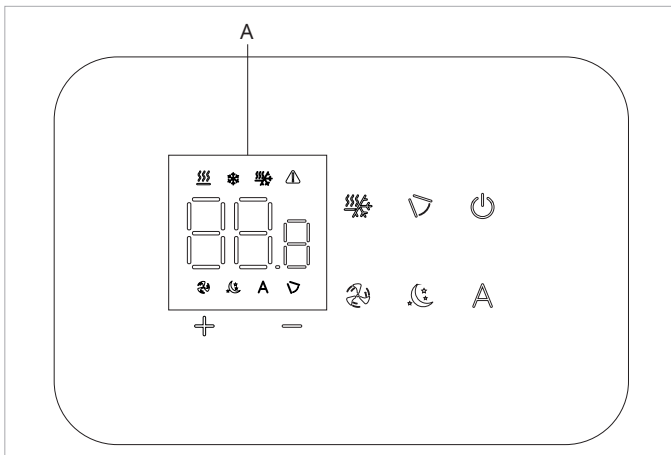

A	Display area
88.8	Setpoint
⚠	Alarm signals
📏	Moving Deflector Control function active
🌀	Active ventilation function
🔥❄️	Heating / Cooling (Cannot be used)
❄️	Cooling operating mode active
🔥	Heating operating mode active
⏸	Automatic function active
🌙	Night function active

7.1.3 Keys functions

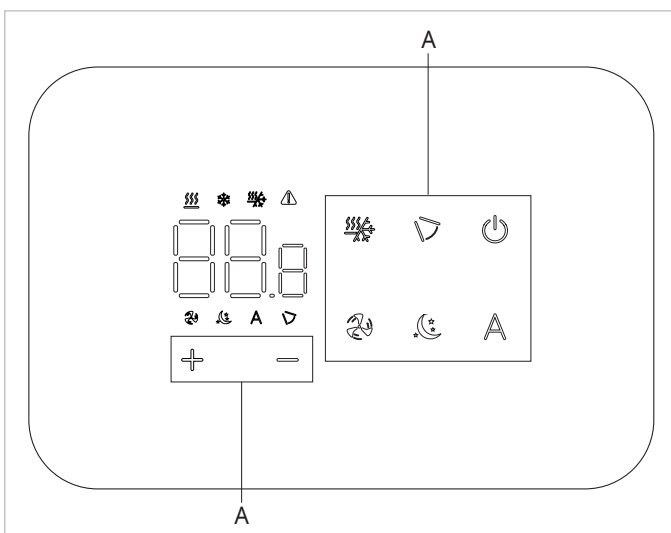

A	Keys area
+	Up key
-	Down key
🔌	This can be used to switch the unit on or off
📏	Allows you to activate the Moving Deflector Control function
🌀	Allows you to control ventilation speed
🔥❄️	This can be used to select the operating mode (Cooling or Heating) or Autochangeover
⏸	Enables the Automatic function
🌙	Enables the Night function

7.2 Installation

7.2.1 Description

The wall-mounted remote control is an electronic LED thermostat with a touch interface, with the possibility of controlling multiple appliances equipped with the same electronic board. It is equipped with a temperature and humidity probe.

- ⚠ The control can manage a maximum of 16 units.
- ⚠ The app "Innova" is available to control the following command.

7.2.2 Mounting

- ⚠ The control panel for wall control is to be installed inside a 503 electrical box.
- ⚠ A wall must be prepared to accommodate the 503 electrical box before installing the wall control.
- ⚠ Ensure that:
 - the wall supports the weight of the appliance
 - the section of the wall does not contain piping or electrical lines
 - the functionality of load-bearing elements is not compromised

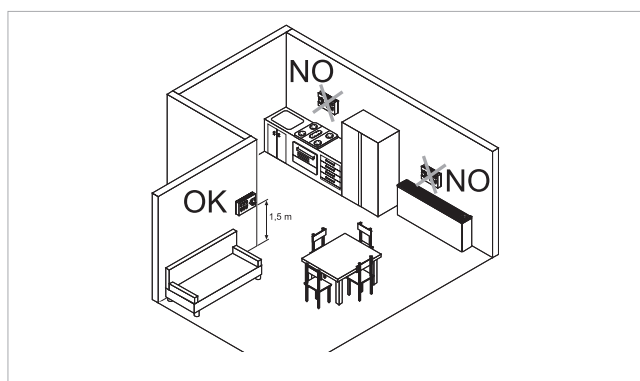

The wall-mounted remote control must be installed:

- on internal walls
- at a height of about 1,5 m from the floor

- ⚠ Should the control be located in an area utilised by persons with reduced physical capabilities, please refer to local regulations.
 - away from doors or windows
 - away from heat sources (heaters, convectors, stoves, direct sunlight)
- ⚠ The wall control is provided inside the package already assembled.

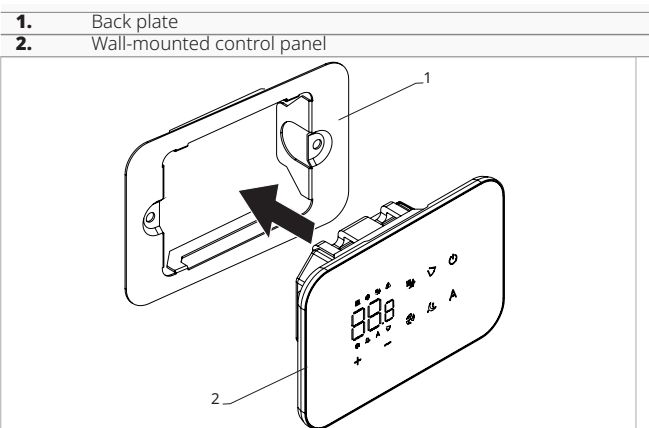

Before wall installation:

- ▶ separate the back plate from the control panel

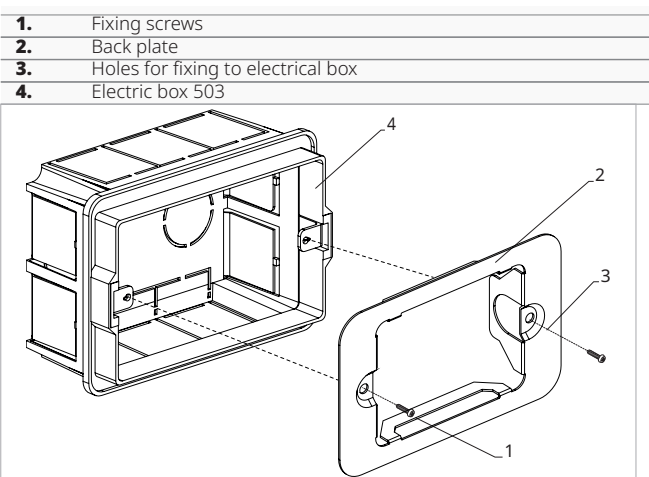

For wall mounting of the control panel:

- ▶ fix the control base to the electrical box 503 with screws
- ▶ connect the electrical wiring

- ⚠ Before making the connections, please verify that the control terminal block is on the right-hand side.

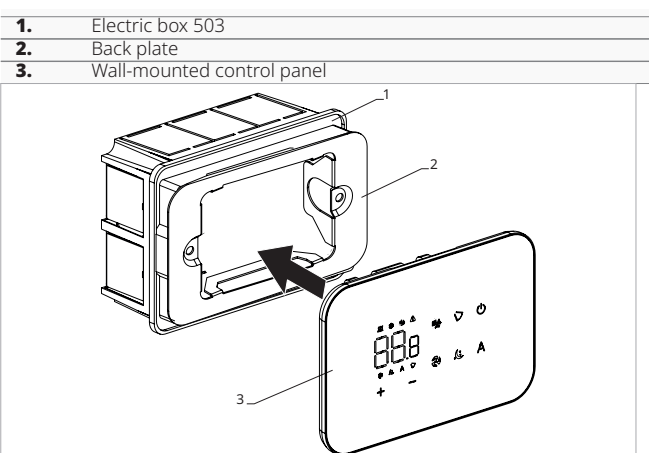

- ▶ Close the control panel

- ⚠ Pay attention not to crush the conductors when you close the control.

Controls

7.3 Single connection diagram

1.	M7 series wall control panel	BA	Serial connection for wall-mounted remote control
2.	Terminal block for device connection	-+	12 V-DC 1A power supply
CP	Presence contact (normally open)	M7	Command for wall control M7

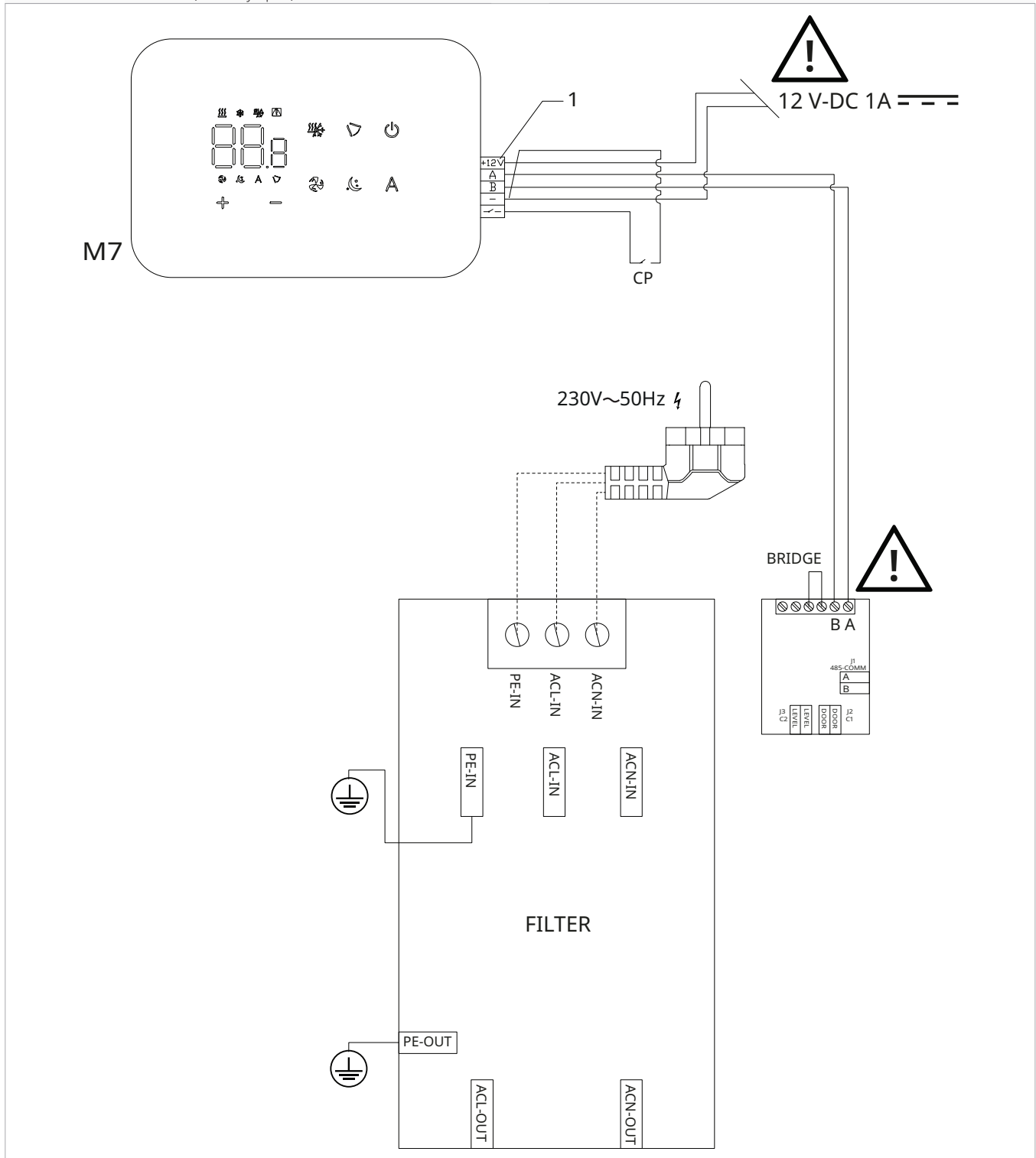

- ⚠ **Reverse A and B for connecting the wall control panel with the board.**
- ⚠ **Power for the control is to be supplied through a 12 V-DC 1A power supply (not field supplied)**
- ⚠ The app "Innova" is available to control the following command.

7.4 Multiple connection diagram

1.	M7 series wall control panel	BA	Serial connection for wall-mounted remote control
2.	Terminal block for device connection	-+	12 V-DC 1A power supply
CP	Presence contact (normally open)	M7	Command for wall control M7

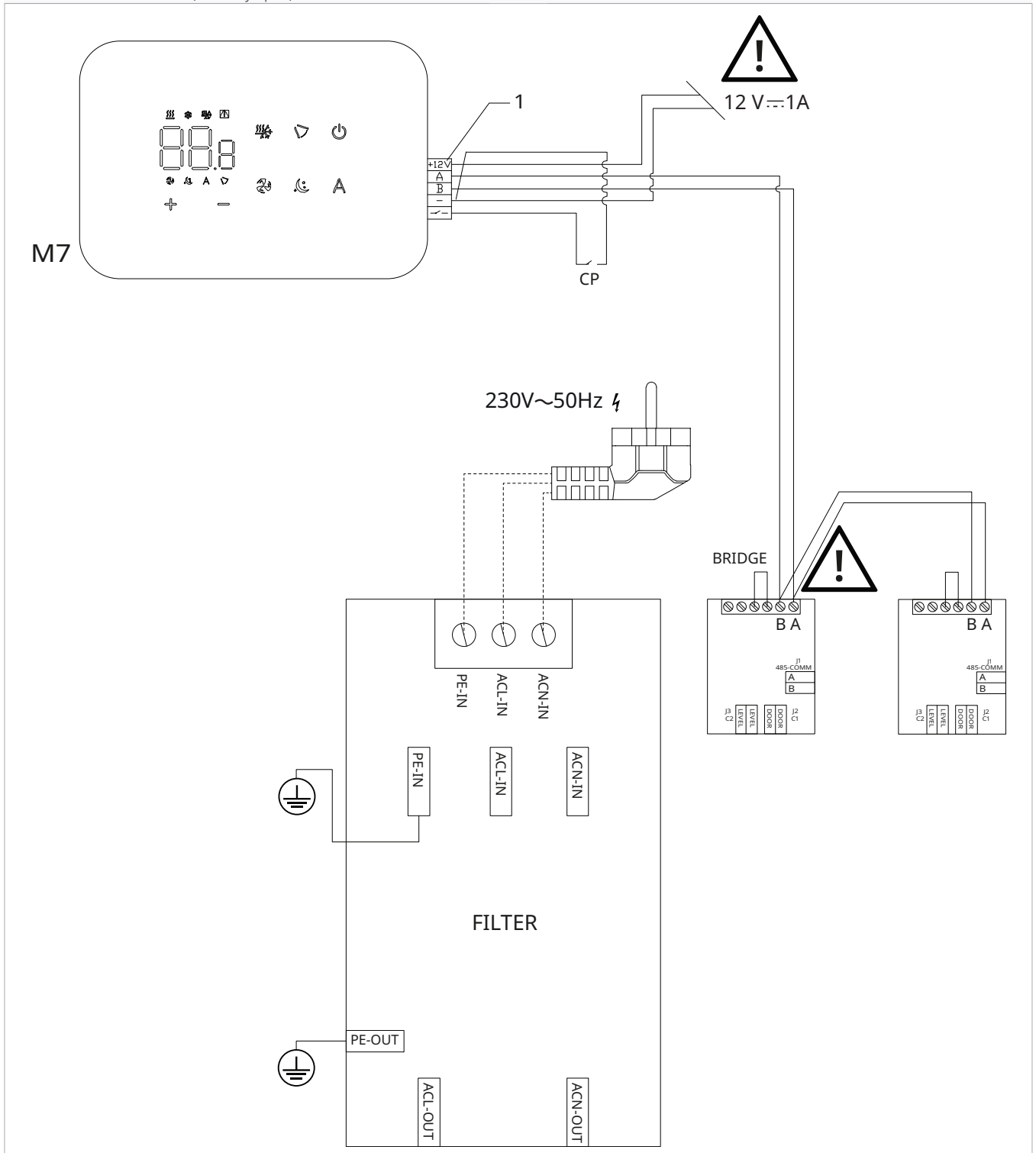

⚠ Reverse A and B for connecting the wall control panel with the boards.

⚠ Power for the control is to be supplied through a 12 V-DC 1A power supply (not field supplied)

⚠ For wall control code EFB749, the app is available.

Controls

7.5 Connections

7.5.1 Preliminary warnings

⚠ The terminals for connecting the control panel and the presence contact CP are inserted in a plastic bag and placed inside the electrical box.

1. Terminal blocks

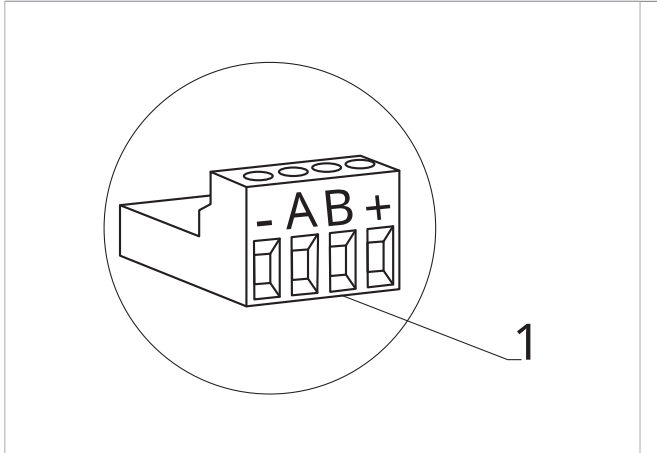

The terminals accept:

- rigid or flexible wires with a 0.2 to 1 mm² cross-section
- rigid or flexible wires with 0,5 mm² cross-section if two wires are connected to the same terminal block
- rigid or flexible wires with 0,75 mm² cross-section if the wires have wire end ferrules with a plastic collar

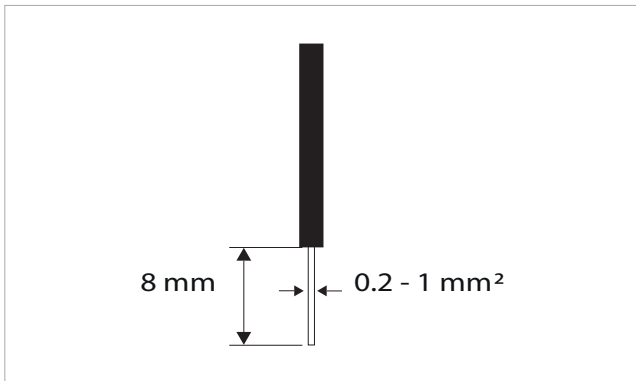

To connect the cables:

- ▶ strip 8 mm of the wire
- ▶ if the wire is rigid, you can insert it easily whereas
- ▶ if it is flexible, use appropriate crimp terminals
- ▶ push the wire in completely
- ▶ check the right fixing by pulling it gently

7.5.2 Control Panel

⚠ The control panel for wall control must be ordered separately.

Terminal block position:

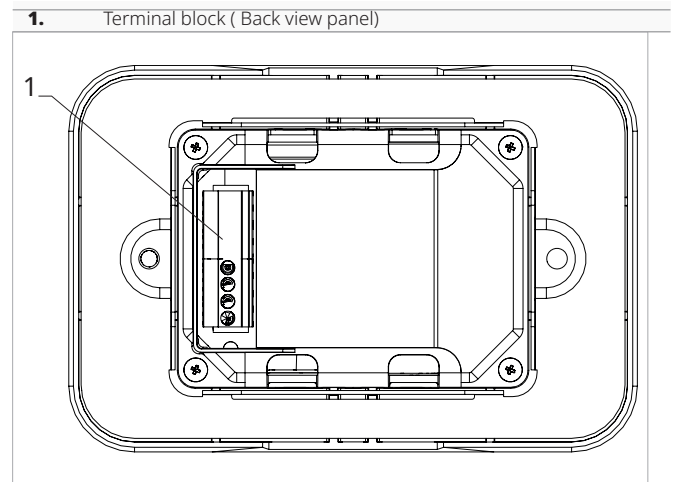

To make the connections:

- ▶ connect the + - power supply wires to a 12 V-DC 1A power supply
- ▶ connect the ModBus serial connection cables to terminals A and B

7.5.3 Presence contact CP

Through this device it is possible to connect an external control signal that inhibits the operation of the control signal, for example:

- opening window contact
- remote on/off
- infrared presence sensor
- activation badge
- remote change of season

Function

The contact is normally open (NO).

- ▶ when closing the CP contact, connected to a potential-free contact, the device switches to stand-by mode
- CP appears on the display.*
- ▶ At the touch of a button on the display the symbol ⚠ flashes.

⊖ It is forbidden to connect the CP input to that of another unit electronic board. Use separate contacts.

The CP presence contact can be configured for heating and cooling operation via the "To select digital input" *p. 47* settings menu item (digital input).

7.5.4 RS485 Serial Connection

The wall-mounted remote control can be connected through an RS485 serial line to one or more devices, up to a maximum of 16.

The devices must be equipped with an electronic board suitable for remote control.

For the connection:

- ▶ follow the indication on the connection diagram
- ▶ connect respecting the polarity indication A and B

- ⚠ Use a two core cable shielded cable suitable for the RS485 serial connection with a minimum section of 0,35 mm².
- ⚠ Keep the two core cable separate from power supply cable by a minimum of 50 mm.
- ⚠ Create a wire path in order to minimize the length of the lead wire.
- ⚠ Complete the line with the 120 Ω resistor.

- ⊖ It is forbidden make star connections.





7.5.5 Extended display

- ⚠ To enable device connectivity and enable selection of fan power level, the display must be extended. See section "Extended display" p. 47.

7.6 Functions

7.6.1 Basic menu

To access the basic menu

- ▶ with the display off, hold down  for 10 seconds
The device turns on and  appears
- ▶ keep pressed until the indication  appears
- ▶ release the  key
The symbol  appears

To navigate in the menu

- ▶ use the icons  

To select a menu item and to confirm the changes made

- ▶ press the icon 
Confirming the change takes you to the next item.

To exit the menu

- ▶ press the icon  for 10 seconds
- ▶ or wait 30 seconds the automatic shutdown

- ⚠ After 30 seconds from the last action the control returns to the start screen and the last chosen values are memorised.

Menu items

ot: AIR probe offset (air probe setting)

ur: Value read by the R.H. sensor

ut: Probe Offset PT4

us: Humidity setpoint

uI: Humidity hysteresis

CF: Scale

ub: Buzzer volume





uu: Wi-Fi reset

up: Wi-Fi pairing

ho: Hotel Mode





Set AIR probe offset

To set the air probe offset

- ▶ select 
- ▶ press  to change settings
- ▶ increase or decrease the value with the icons  
- ▶ press  to confirm
*By default it is set to 0.
The setting range is from a minimum of -12.0 °C to a maximum of 12.0 °C.*

Set AIR probe offset





To set the air probe offset

- ▶ select 
- ▶ press  to change settings
- ▶ increase or decrease the value with the icons  
- ▶ press  to confirm
*By default it is set to -2,5°C.
The setting range is from a minimum of -12.0 °C to a maximum of 12.0 °C.*

Set probe offset RH

- ⚠ Modify only after real deviations from an actual measurement has been established with professional equipment.





To set the RH probe offset

- ▶ select 
- ▶ press  to change settings
- ▶ increase or decrease the value with the icons  
- ▶ press  to confirm
By default it is set to -2.

Controls





Set the humidity setpoint

To set the humidity setpoint

- ▶ select 
- ▶ press  to change settings
- ▶ increase or decrease the value with the icons  
- ▶ press  to confirm
*By default it is set to 50.
The setting range is from 20.0% to 90.0%.*



Setting the humidity hysteresis

To set the humidity hysteresis

- ▶ select 
- ▶ press  to change settings
- ▶ increase or decrease the value with the icons  
- ▶ press  to confirm
*By default it is set to 5.
The setting range is from 1 (min) to 30 (max).*





Scale

To change the temperature unit of measure

- ▶ select 
- ▶ press  to change settings
- ▶ select °C or °F
- ▶ press  to confirm
By default the temperature unit of measure is °C.

Adjusting the volume



To change the volume

- ▶ select 
- ▶ press  to change settings
- ▶ increase or decrease the value with the icons  
- ▶ press  to confirm
*By default it is set to 1.
The volume setting range is from 00 (min) to 03 (max).*

 The volume changes after confirming the modification.









Factory reset

To reset the factory parameters

- ▶ select 
- ▶ press  to change settings
- ▶ select No to keep current parameters
- ▶ select Yes to reset the factory parameters
- ▶ press  to confirm
By default digital input is set to No.









Wi-Fi reset

To reset the Wi-Fi credentials and return the device to its original configuration

- ▶ select 
- ▶ press  to change settings
- ▶ use the   icons in sequence
Appears 
- ▶ press 
-   appears to reset Wi-Fi credentials.*
- ▶ press  to confirm
Credentials have been reset.

Activate Wi-Fi

To activate Wi-Fi

- ▶ select 
- ▶ press  to change settings
- ▶ use the   icons in sequence
Appears 
- ▶ press 
-   appears to enable Wi-Fi pairing.*
- ▶ press  to confirm

 The device remains visible on the App for the first 15 minutes after the device is switched on.

Setting the Hotel Mode

To set the Hotel mode

- ▶ select 
- ▶ select YS to turn on Hotel mode
- ▶ select NO to turn off the Hotel mode
By default the device is set to NO.

Activating the Hotel mode:





- the Autochangeover function is deactivated
- the temperature setting range is reduced, in Cooling you can set from 22 °C to 28 °C, in Heating you can set from 16 °C to 24 °C

7.6.2 Advanced Menu

 **To access the setup menu, it is necessary to access the Basic menu. See section "Basic menu" p. 45.**



The special functions menu can be accessed via the control panel.

To access the advanced menu

- ▶ from the basic menu press 
Appears 
- ▶ press the  key once
Appears 

- ▶ press  to confirm and log in
The advanced menu is accessed.



To navigate in the menu

- ▶ use the icons  

To select a menu item and to confirm the changes made

- ▶ press  for 2 seconds
Confirming the change takes you to the next item.

To exit the menu

- ▶ press  for about 10 seconds
Appears .
- ▶ press  for about 10 seconds
The display turns off.
- ▶ or wait 30 seconds after the last action
The display is switched off automatically.

 After 30 seconds from the last action the control returns to the start screen and the last chosen values are memorised.

Menu items

Ad: Not used

Pr: Not used

di: Options for digital input

t1: Not used

rH: Not used

rC: Not used

UC: Not used

Ac: Not used

Ah: Not used



Ed: Extended display

Ab: Enabling brightness sensor



Fr: Not used

To select digital input

To change the digital input

- ▶ select 
- ▶ press  to change settings
- ▶ select CP for presence contact (default)
- ▶ select CO to cooling open
- ▶ select CC to cooling close
- ▶ press  to confirm
By default digital input is set to CP.

 For return to the default settings, set the digital input to "CP".

 By selecting one of the other inputs (CO,CC) the seasonality is locked. It is not possible to modify it through the key  of the control.

Extended display

 **Allows device connectivity and enables the selection of the ventilation power level.**

 To use the ventilation speed selection, it is necessary to enable the display extension.





To enable the display extension

- ▶ select 
- ▶ select no to disable
- ▶ select Ys to enable
By default, the device is set to no.

Optical sensor

 By default, the brightness sensor is set.

To disable the brightness sensor:

- ▶ select 
- ▶ press 
Appear Ys.
- ▶ press 
- ▶ select no
- ▶ press  to confirm
The brightness sensor is disabled.

 The brightness sensor adapts to room lighting.

7.6.3 Alarm display on wall control panel

 In the event of an alarm, the device still maintains active functions.

 Alarm codes are shown on the on-board display. Refer to the "Visualisation of alarms on display" *p. 33* chapter for the complete list.

Routine maintenance is essential to keep the device efficient, safe, and reliable over time.

8.1 Preliminary warnings

⚠ This section is dedicated to the Authorised Service Centre. The features of the Authorised Service Centre are described in chapter "Recipients" p. 5.

Before each cleaning and maintenance intervention:

- ▶ disconnect the device from the power supply by turning the system main switch to "OFF"
- ▶ wait for the components to cool down in order to avoid any burns
- ⊖ Carrying out any technical or cleaning work before disconnecting the unit from the power supply is forbidden.
- ⚠ Make sure that there is no voltage before operating.
- ⚠ After completing the maintenance work, the unit must be restored its original condition.

⚠ Handle refrigerant with care. Leaking refrigerant can cause freezing.

8.1.1 Specific warnings R32

- ⚠ R32 refrigerant gas is mildly flammable and odourless.
- ⚠ Check that there are no sources of ignition in continuous operation (open flames, gas appliances, electric stoves, lighted cigarettes, etc.).
- ⊖ Smoking in the vicinity of the appliance is prohibited.
- ⊖ Using a mobile phone near the appliance is prohibited.
- ⊖ Using leak detectors with halogen lamps is prohibited.

8.2 Routine maintenance

The routine maintenance plan includes the following cleaning operations.

Carry out cleaning:

- every six months

8.2.1 External cleaning

Clean the external surfaces with a soft damp cloth.

- ⚠ Disconnect the unit from the power supply before each cleaning and maintenance intervention by setting the main power supply switch to off.
- ⚠ Do not use abrasive sponges, or abrasive or corrosive detergents, as you might damage the painted surfaces.

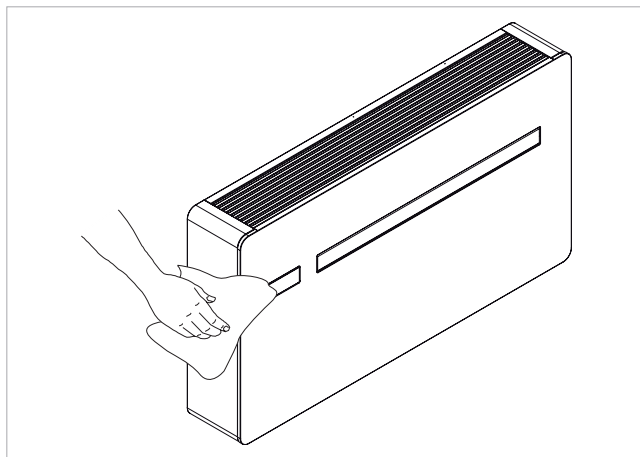

8.2.2 Cleaning the filters

Clean the air filter after a period of continuous use and according to the concentration of impurities in the air, or when you wish to start-up the appliance after a period of inactivity.

- ⚠ The filter is located in the bottom part of the appliance.
- ⚠ Wait for the components to cool down in order to avoid any burns.
- ⚠ Pay attention to the sharp edges.
- ⚠ For grille disassembly operations see chapter "Removal of aesthetic panels and grilles" p. 27.
- ⚠ For grille assembly operations see chapter "Assembly of aesthetic panels and grilles" p. 29.
 - ▶ extract the filter by lifting it
 - ▶ remove the dust from the filter with a vacuum cleaner or by washing it in running water
 - ▶ allow it dry
 - ▶ put the filters back on top of the coils, taking care to position them correctly
- ⚠ Do not use detergents or solvents.
- ⚠ After filter cleaning check if the panel is properly mounted.
- ⊖ It is forbidden to use the device without mesh filter.



8.3 Replacement of UV lamp kit

8.3.1 Warnings

- ⚠ Pay attention that UV rays are emitted from this product.
- ⚠ Avoid eye and skin exposure to unshielded product.
- ⚠ Disconnect the unit from the power supply before each cleaning and maintenance intervention by setting the main power supply switch to off.
- ⚠ Wait for the components to cool down in order to avoid any burns.
- ⚠ Pay attention to the sharp edges.

8.3.2 Procedure

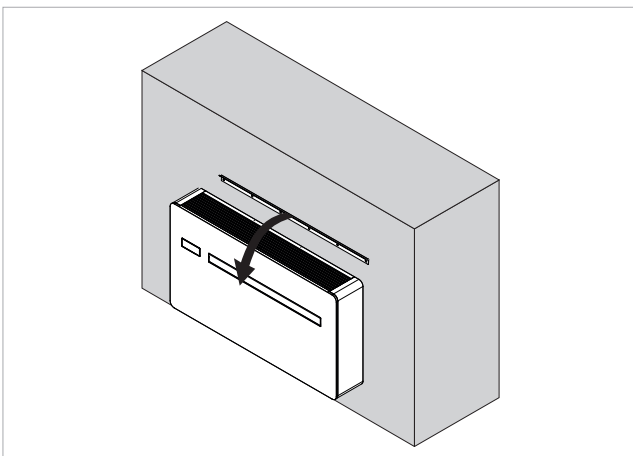

- ▶ disconnect the unit from the power supply
- ▶ remove the unit from the wall

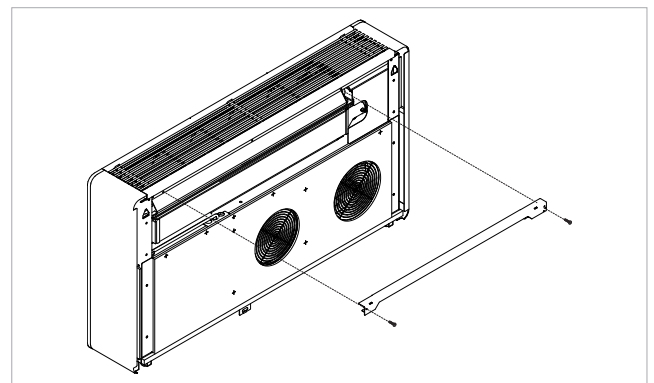

- ▶ unscrew the rear fixing screws of the lamp bracket
- ▶ disconnect the kit's power cable
- ▶ replacing the lamp

9. TROUBLESHOOTING

9.1 Troubleshooting table

In the even of a malfunction, please refer to the following table. If, after performing the suggested checks, the prob-

lem is not solved, please contact the Authorised Technical Assistance.

Anomalies	Possible causes	Remedies
The appliance doesn't switch on	No power supply	Check there is power supply (by turning a light on, for example). Check that the thermal-magnetic circuit breaker used exclusively to protect the appliance has not been tripped (if it has, reset it). If the problem repeats immediately, please call the Service Centre and avoid trying to make the appliance work.
	Remote control batteries have run out	Check that the appliance can be turned on using the touch-screen display and substitute the batteries.
The appliance does not cool/heat adequately.	The set temperature is too high or too low.	Check and, if necessary, adjust the temperature setting on the remote control
	The air filter is clogged	Check the air filter and clean it if necessary
	Check that there are no other obstacles to the air flow both inside and outside the appliance.	Remove anything that might block the air flow.
	The heating and cooling load has increased (for example, a door or a window has been left open or an appliance has been installed in the room which generates a lot of heat).	Try to reduce the heating and cooling load of the room following instructions below: Cover large windows exposed to sunlight with curtains or with external maskings (blinds, porches, reflecting films, etc.); The air conditioned room must remain closed for as long as possible; Avoid turning on halogen lamps or other high energy consumption appliances such as small ovens, steam irons, hot plates etc.).

9.2 Diagnosis of possible anomalies

If the conditioner blocks because of an alarm (see following table), please communicate to the assistance centre the code on the display to facilitate interventions.

9.2.1 Open CP contact

If the presence contact is not closed, the appliance will not start and the CP alarm appears on the display.

Please refer to chapter "CP occupancy contact input connection" p. 26.

9.2.2 Maximum condensate collection level warning

In heating operation, condensate drains free through the appropriate pipe.

In case of an OF alarm, check that the condensation drain line is not bent or obstructed to prevent water from draining out.

In cooling or dehumidification function, in extreme operating condition (high temperature and high humidity) the unit may not be able to automatically dispose of the produced condensate, in this case the display will show OF.

The OF sign, is not an error, but an alarm indicating that the water has reached the maximum level of the condensate drip tray.

In this case, it is necessary to drain the condensate manually:

- ▶ place a drip pan (not provided) below the condensate drain pipe
- ▶ drain the water using the cap on the condensate drain pipe

⚠ If after performing the procedure, the OF alarm remains, you should contact the Technical Service Center.

9.2.3 Use of the appliance

⚠ Objects or structural obstacles (furniture, curtains, plants, leaves, blinds, etc.) must not obstruct the normal air flow both from the internal and from the external grilles.

⚠ Do not lean against, or worse sit on, the body of the conditioner, this would damage the appliance.

⚠ Do not move the horizontal air outlet flap manually. Always use the remote control to perform such operation.

⚠ In the event of water leaks, turn off the appliance and disconnect the electric power supply. Call the nearest service centre.

⚠ During heating mode, the conditioner eliminates periodically any ice formed on the external battery. In such situation, the machine keeps on working, but it does not dispense warm air to the room. This phase can last from 3 up to maximum 10 minutes.

⚠ The appliance must not be installed in rooms where explosive gases develop or where there are humidity and temperature conditions that exceed the maximum levels reported on the installation manual.

⚠ Clean the air filter regularly as described in the specific paragraph.

9.3 Visualisation of alarms on display

Code	Alarm description	Solution
Er01	Room temperature probe error (RT)	If the alarm does not automatically reset, disconnect and reconnect the power supply. If the alarm does not reset, contact the Authorised Service Centre.
Er02	Error of the temperature sensor of the internal heat exchanger (IPT)	If the alarm does not automatically reset, disconnect and reconnect the power supply. If the alarm does not reset, contact the Authorised Service Centre.
Er03	Error outdoor air temperature probe (OT)	If the alarm does not automatically reset, disconnect and reconnect the power supply. If the alarm does not reset, contact the Authorised Service Centre.
Er04	Error of the external heat exchanger temperature probe (OPT)	If the alarm does not automatically reset, disconnect and reconnect the power supply. If the alarm does not reset, contact the Authorised Service Centre.
Er05	Malfunctioning of the internal fan	Disconnect and restore power to the appliance. If the malfunction persists, contact the Authorised Service Centre.
Er06	Malfunction of the external fan	Disconnect and restore power to the appliance. If the malfunction persists, contact the Authorised Service Centre.
Er07	Driver communication error	Disconnect and restore power to the appliance. If the malfunction persists, contact the Authorised Service Centre.
Er08	Compressor discharge temperature probe (TD) error	If the alarm does not automatically reset, disconnect and reconnect the power supply. If the alarm does not reset, contact the Authorised Service Centre.
Er09	Communication error with remote thermostat M7	Check that thermostat M7 is switched on and that the set functions are activated on the appliance. Otherwise, contact the Authorised Service Centre.
Er10	Maximum level float intervention in the condensate drip tray (ALARM)	The condensate drain is not functioning properly, contact the Authorised Service Centre
CP	Open (CP) contact	Open contact. The appliance only switches on when the contact is closed, check the terminal connection.
Er12	Driver error - compressor failure	Disconnect and restore power to the appliance. If the malfunction persists, contact the Authorised Service Centre.
CE	Communication error between main circuit board and display	You cannot see the function on the display, please contact the Authorised Service Centre.
Er16	4-way valve management error or alarm for insufficient refrigerant charge	Disconnect and restore power to the appliance. If the malfunction persists, contact the Authorised Service Centre.
Er17	Driver parameter error or compressor incompatibility	Disconnect and restore power to the appliance. If the malfunction persists, contact the Authorised Service Centre.
Er19	Heating element safety temperature probe error (LEVEL)	If the alarm does not automatically reset, disconnect and reconnect the power supply. If the alarm does not reset, contact the Authorised Service Centre.
Er20	Error of the second temperature probe of the external heat exchanger (GT)	If the alarm does not automatically reset, disconnect and reconnect the power supply. If the alarm does not reset, contact the Authorised Service Centre.
Er22	Wrong power supply	Disconnect and restore power to the appliance. If the malfunction persists, contact the Authorised Service Centre.
Er23	UV lamp kit error	Disconnect and restore power to the appliance. If the malfunction persists, contact the Authorised Service Centre.
Er24	ERV kit error	Disconnect and restore power to the appliance. If the malfunction persists, contact the Authorised Service Centre.
BL	Key lock	To unlock the display, press simultaneously + for 3 seconds.

10. TECHNICAL INFORMATION

10.1 Technical data

Models	u.m.	2.3kW	3.1kW	3.1kW Elec	
Cooling performance (AT 35°C; AT 27°C)					
Maximum cooling capacity Dual Power	(1)	kW	2,64	3,10	3,10
Nominal cooling capacity	(1)	kW	2,09	2,33	2,33
Minimum Cooling Capacity	(1)	kW	0,83	0,92	0,92
Dehumidification capacity		L/h	0,8	0,9	0,9
total input power		kW	0,64	0,72	0,72
Energy efficiency class	(2)		A+		
EER			3,29	3,25	3,25
SEER			4,70	4,60	4,60
Energy efficiency class (EN 14825)	(3)		B		
Heating performance (AT 7°C; AT 20 °C)					
Maximum heat output Dual Power	(4)	kW	2,64	3,05	3,05
Nominal heat power	(4)	kW	2,08	2,31	2,31
Electric heater additional power		kW	-	-	0,90/1,80
Minimum heat output	(4)	kW	0,71	0,79	0,79
Total absorbed power	(4)	kW	0,63	0,71	0,71
COP			3,31	3,28	3,28
Energy class			A+		A
SCOP			3,80	3,70	3,70
Energy efficiency class (EN 14825)	(3)		A		
Aeraulic data indoor (5)					
Ventilation speed	(6)	Nr.	3+2	3+2	3+2
Electrical data					
Maximum absorbed power		kW	0,95	1,06	2,86 (7)
Maximum absorbed current		A	4,10	4,60	12,40 (7)
Power Supply		V/ph/Hz	230/1/50	230/1/50	230/1/50
Aeraulic data indoor (5)					
Maximum air flow		m ³ /h	380	400	400
General characteristics					
Maximum indoor air flow		m ³ /h	380	400	400
Maximum external air flow		m ³ /h	460	480	480

1. Outdoor air temperature 35 °, relative humidity 41%. Ambient temperature 27 ° C; relative humidity 47%. Performance according to EN 14511
2. Energy Efficiency according to Directive 626/2011- Valid for tax deduction
3. Energy classification according to EN 14825: 2022
4. Fresh air temperature 7 °C, relative humidity 87%. Room temperature 20°C, relative humidity 59% (max). Performance according to UNI 14511
5. Efficiency according to UNI EN 13141-7 Indoor temperature 20 °C - Indoor humidity 28 % - Outdoor temperature 7 °C - Outdoor humidity 72 %
6. 3 manual speed + auto speed + boost speed
7. Data calculated with electric heating element set at maximum power (1.8 kW).
8. Internal side sound pressure measured in semi-anechoic chamber at a distance of 2 m.

Technical Data

Models		u.m.	2.3kW	3.1kW	3.1kW Elec
Medium indoor air flow		m ³ /h	310	320	320
Medium air flow external		m ³ /h	380	390	390
Minimum indoor air flow		m ³ /h	260	270	270
Minimum external air flow		m ³ /h	330	340	340
Type of compressor			Rotary - DC Inverter		
Sound data					
Nominal sound pressure	(8)	dB(A)	39	41	41
Minimum sound pressure level	(8)	dB(A)	26	27	27
Refrigerant gas data					
Type of refrigerant			R32		
Quantity of refrigerant		kg	0,50	0,50	0,50

1. Outdoor air temperature 35 °, relative humidity 41%. Ambient temperature 27 ° C; relative humidity 47%. Performance according to EN 14511
2. Energy Efficiency according to Directive 626/2011- Valid for tax deduction
3. Energy classification according to EN 14825: 2022
4. Fresh air temperature 7 °C, relative humidity 87%. Room temperature 20°C, relative humidity 59% (max). Performance according to UNI 14511
5. Efficiency according to UNI EN 13141-7 Indoor temperature 20 °C - Indoor humidity 28 % - Outdoor temperature 7 °C - Outdoor humidity 72 %
6. 3 manual speed + auto speed + boost speed
7. Data calculated with electric heating element set at maximum power (1.8 kW).
8. Internal side sound pressure measured in semi-anechoic chamber at a distance of 2 m.

Reference conditions

		Environment T	External T
(1)	Cooling mode tests (EN 14511)	DB 27°C - WB 19°C	DB 35°C - WB 24°C
(2)	Heating mode tests (EN 14511)	DB 20°C - WB 15°C	DB 7°C - WB 6°C
(3)	Heating mode tests	DB 20°C - WB 15°C	DB -7°C - WB -8°C
(4)	Internal side sound pressure measured in semi-anechoic chamber at a distance of 2 m.		
(5)	Internal side sound pressure measured in accordance with regulation EN 12012		

Operating limits

	Room temperature T	External temperature T
Maximum operating temperature in cooling mode	32 °C	43 °C
Minimum operating temperature in cooling mode	18 °C	-5 °C
	Room temperature T	External temperature T
Maximum operating temperatures in heating mode	25 °C	18 °C
Minimum operating temperatures in heating mode	5 °C	-15 °C (-25 °C for ELEC versions)

Technical Data

10.2 Dimensions

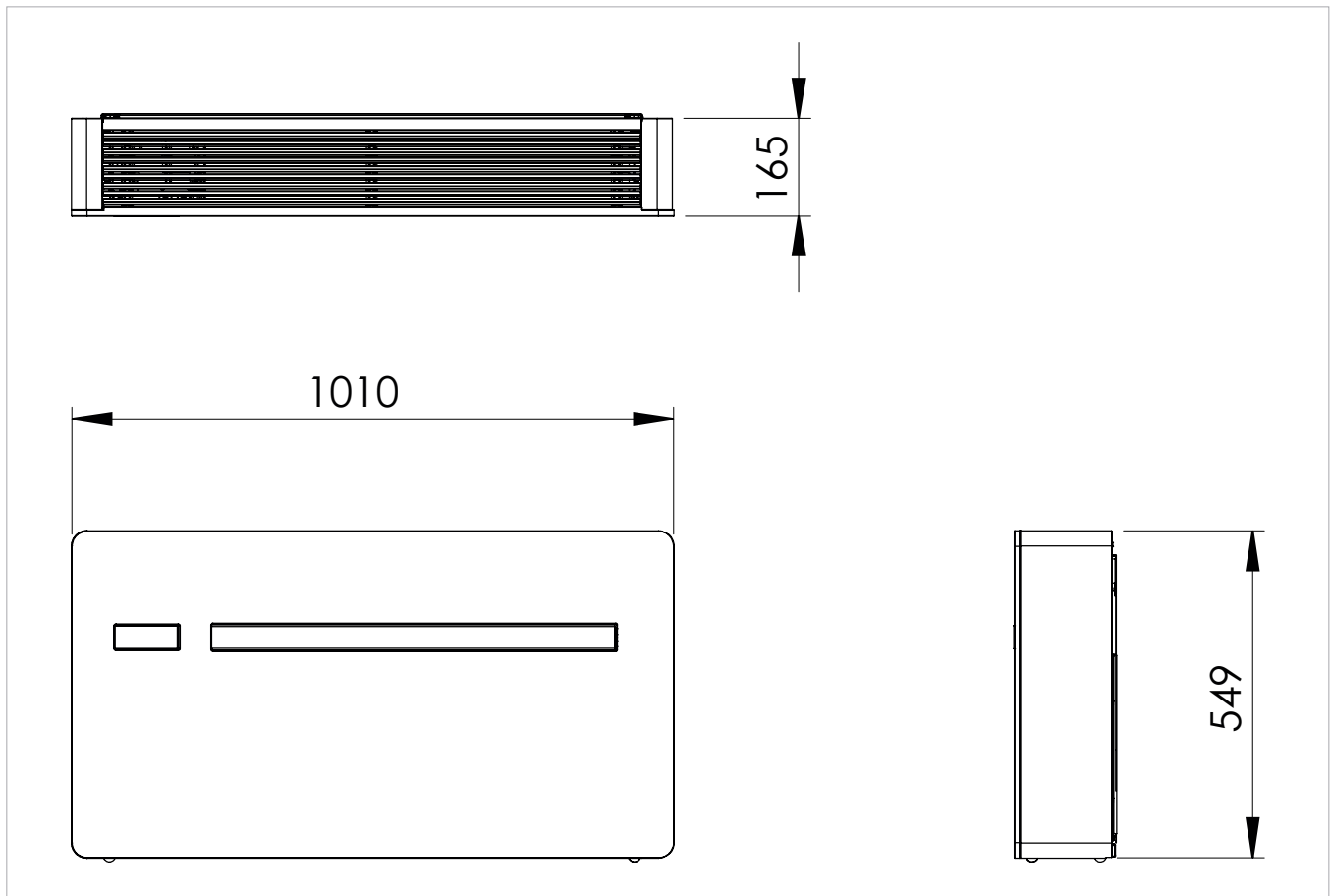

Models	u.m.	Vision 2.3	Vision 3.1	Vision 3.1 Elec
Product dimensions and weight				
Width	mm	1010	1010	1010
Height	mm	549	549	549
Total depth	mm	165	165	165
Empty weight	kg	41,0	41,0	41,0
Wall hole diameter	mm	162	162	162
Wall holes distance	mm	293	293	293

10.3 RED Compliance Statement

Compliance with 2014/53/EU Radio Equipment Directive (RED).

In accordance with Article 10.8(a) and 10.8(b) of the RED, the following table provides information on the frequency

Frequency range (MHz)	Max. Transmit Power
2400-2472	<20

Hereby, the company declares that the device is in compliance with Directive 2014/53/EU.

⚠ For declarations of conformity, certificates and other certification details please consult the website.

bands used and the maximum RF transmit power of the product for sale in the EU:

This equipment should be installed and operated with a minimum distance of 20 centimeters between the radiator and your body.

10.4 Safety

This equipment is designed with the utmost care for the safety of those who install and use it. However, special attention must be paid to the dangers of electric shock and static electricity when working with electrical equipment.

All guidelines must therefore be allowed at all times to ensure safe use of the equipment.

10.5 FCC Declaration of Conformity

This equipment complies with FCC radiation exposure limits set forth for an uncontrolled environment. To avoid the possibility of exceeding the exposure limits, maintain a distance of not less than 0.5 cm between the antenna and the person during normal operation.

10.5.1 Warnings

- ⚠ This wireless device uses and can radiate radio frequency energy and, if not installed and used in accordance with the instructions, may cause harmful interference to radio communications.
- ⚠ This device must not be placed or used in conjunction with any other antenna or transmitter.
- ⚠ This equipment complies with the limits for a Class B digital device, pursuant to FCC Rules.
- ⚠ The limits are designed to provide reasonable protection against harmful interference in a residential installation.

10.5.2 Notes on Wi-Fi communication

This equipment complies with the limits for a Class B digital device, pursuant to FCC Rules.

In case of interference:

- increase the distance between the object and the receiver
- immediately contact an Authorised Service Centre or suitably qualified personnel

EU countries intended for use

The version of this device is intended for home and business use in Austria, Belgium, Bulgaria, Cyprus, Czech Republic, Denmark, Estonia, Finland, France, Germany, Greece, Hungary, Ireland, Italy, Latvia, Lithuania, Luxembourg, Malta, the Netherlands, Poland, Portugal, Romania, Slovakia, Slovenia, Spain, Sweden, Turkey and the United Kingdom and is also authorised in the EFTA Member States: Iceland, Liechtenstein, Norway and Switzerland.

EU countries not intended for use

None.

Getting In Touch

Powrmatic Limited
Hort Bridge, Ilminster
Somerset
TA19 9PS
tel: **+44 (0) 1460 53535**
fax: **+44 (0) 1460 52341**
e-mail: **info@powrmatic.co.uk**
web: **www.powrmatic.co.uk**



Powrmatic Ireland
45 Broomhill Close
Tallaght
Dublin 24
tel: **+353 (0) 1452 1533**
fax: **+353 (0) 1452 1764**
e-mail: **info@powrmatic.ie**
web: **www.powrmatic.ie**

More information is available from our website by scanning the following QR code.



Powrmatic pursues a policy of continuous improvement in both design and performance of its products and therefore reserves the right to change, amend or vary specifications without notice. Whilst the details contained herein are believed to be correct they do not form the basis of any contract and interested parties should contact the Company to confirm whether any material alterations have been made since publication of this brochure.