

POWRMATIC®

CECx

User, Installation & Servicing Manual

Issue 3.7 Apr 2026



Certificate Of Guarantee

POWRMATIC® **Certificate of Guarantee**

This is to certify that this destratification fan is guaranteed for a period of two years from the date of original installation.

To make a claim

In the first instance you must contact your appliance supplier, or installer and provide:-

1. The appliance type and serial number.
2. The original commissioning documentation. As much detail as possible on the fault.
3. Your supplier, or installer, will then contact Powrmatic to make a guarantee claim on your behalf.

Conditions of Guarantee

1. The destratification fan must have been installed by a competent recognised installer, and in accordance with the manufacturer's instructions, I.E.E. regulations and local regulations.
2. The destratification fan has been used in accordance with the manufacturer's instructions.
3. No unauthorised repairs or modifications have been made. Powrmatic 'General Conditions of Sales' have been observed.
4. Except for the obligation of Powrmatic Ltd to perform warranty repairs during the guarantee period Powrmatic will not be liable in respect of any claim for direct or indirect consequential losses, including loss of profits or increased cost arising from loss of use of the heater, or any event arising there from.

Powrmatic Ltd, Hort Bridge, Ilminster, Somerset, TA19 9PS
Tel: 01460 53535 Fax: 01460 52341
Web: www.powrmatic.co.uk e-mail: warranty@powrmatic.co.uk

**Important: This certificate
must be kept with the appliance**

Failure to provide a copy of the commissioning sheet invalidates the heater warranty

Users, Installation and Servicing Instructions

CONTENTS

Title	Section	Contents	Page
Pre Installation	1.1	Introduction	4
		Dimensions	4
	1.2	Technical data	5
	1.3	General Requirements	5
Installation	2.1	Fitting the unit	6
	2.2	Wiring Diagrams	8
	2.3	Commissioning and Testing	8
	2.4	Servicing	9
	2.5	Replacement of Faulty Items	9
Additional Documents	3.1	Short List of Parts	10

1.1 Introduction

The Calecon unit you have installed is operated automatically, by an inbuilt thermostat, to turn on when the air temperature at high level exceeds the thermostat setting.

The Calecon unit will automatically recirculate the high level hot air in high roofed buildings drastically reducing stratification and heat losses and minimise the temperature gradient between low and high level.

The unit will turn off automatically when the air temperature at high level falls below the setting on the thermostat.

Mounted externally on the unit is the air temperature sensing thermostat.

Units are fully pre-wired, fully tested and fitted with four eyebolt suspension points.

In some installations a low level master control may be installed to provide user control of the units.

A) Maintenance

Regular servicing is essential to maintain efficient, reliable and safe operation of the units. Users are strongly recommended to have Calecons serviced by a qualified person at least annually and preferably at the end of the heating season.



Note: access must be maintained to the Calecon units for servicing purposes.



WARNING: All Calecon units use electricity to power them and contain moving parts, the fan. It would be hazardous to tamper with or attempt to service unless you are a competent person in the field of Electrical work.

If you have any safety questions reference the servicing and installation of this equipment please do not hesitate to contact our head office for expert advice. Your safety is paramount to us.

Dimensions

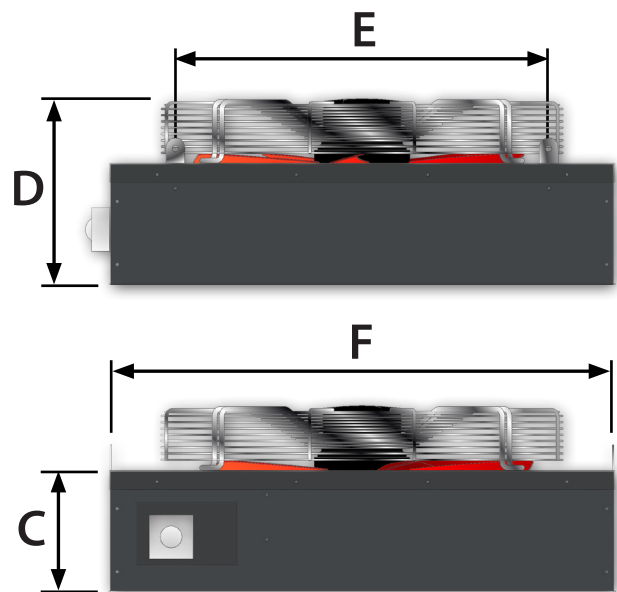
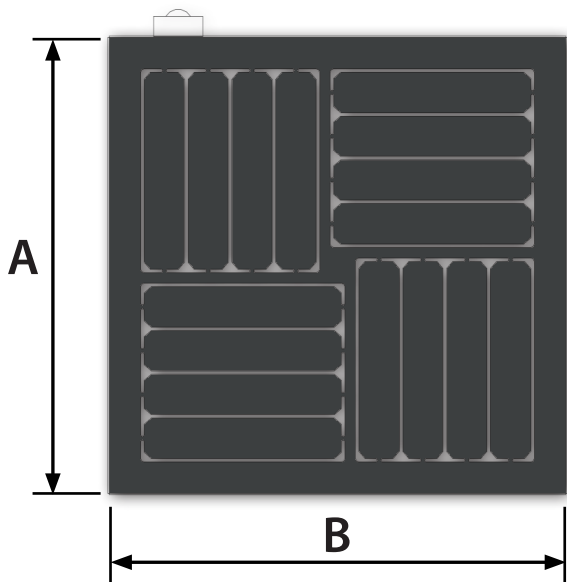

Dim	Model		CECx 1400	CECx 2250	CECx 3350	CECx 6500
A	Enclosure Width	mm	600	600	654	805
B	Enclosure Depth	mm	600	600	654	805
C	Enclosure Height	mm	120	120	120	187
D	Overall Height	mm	250	250	264	305
E	Suspension ctrs	mm	388	388	425.5	597
F	Suspension ctrs	mm	595	595	649	802.5

1.2 Technical Data

Model		CECx 1400	CECx 2250	CECx 3350	CECx 6500	
Airflow**	m³/s	0.8	1.2	1.8	2.6	
	m³/h	2800	4467	6400	9300	
Mounting Height	Maximum	m	6	12	15	25
	Minimum	m	3	3.5	3.8	6
Height to achieve (0.3ms)			4	8	10	18
Electrics	Supply	V/ph/Hz	230V/1Phase/50Hz			
	Start Current	amps	1.3	2.9	3.1	5.7
	Run Current	amps	0.52	0.8	1.5	2.35
Dimensions	Width	mm	600	600	654	805
	Depth	mm	600	600	654	805
	Overall Height	mm	250	250	264	336
Nett weight		kg	15	17.5	21.5	32.5
Fan Noise @ 5m (Q=2)		L _{PA} dB	37	44	44	46
Fan Noise Level		L _{WAS} dB	59	66	66	68*
<i>*Noise Levels: Based Upon fan manufacturers measurements (EBM). **Airflows at 20Pa Pressure</i>						

1.3 General Requirements

1.3.1 Location

Calecon units will be effective in any high roofed building where temperature stratification will otherwise occur.

Units should be installed at the highest available location once the roof architecture and maximum mounting height for the unit have been taken into account (see section 1.2).

Units should be placed in positions where the downward directed airflow will not be impeded by racking or other obstructions. Ensure units are not mounted so as to obstruct the movement of overhead cranes, forklift trucks etc.

Where multiple units are being used, their positioning should ensure as even airflow pattern in the building as practicable, taking into account the positions of any affected occupants.

There should be a minimum of 1-metre free area between the top of the units and the underside of the roof.

Calecon units sited adjacent to roof glazing or large expanses of wall should be avoided as well as situated close to open flued heaters.

'Free heat' can be gained by positioning the Calecon units above heat generating lighting or machinery. Calecon units positioned close to doorways help to quickly restore comfortable conditions after door operation.

1.3.2 Electrical Supply



WARNING: Wiring external to the unit must be installed in accordance with the I.E.E. Regulations and any local regulations which apply.

Calecon units will require a 230V 50Hz 1ph fused supply to operate and are equipped with a cable gland for mains input via an isolator located adjacent to the unit.

The fan motor starting amps are approximately 3 times the full load current.

2.1 Fitting the Unit

2.1.1 General Fitting

The calecon unit is equipped with four suspension points, one on each corner. These take the form of an eyebolt.

Using either our fixing kit, chain or wire rope, connect each point to a rigid construction i.e. Unistrut, girders etc.



WARNING: Ensure the framework is adequate to take the weight of the particular destratification unit. Once the destratification fan is in position, the wiring can commence.

2.1.1.1 CECx Fixing Kit

The CECx fixing kit is a fast locking solution for quick and easy suspension of our CECx destratification fans.

Features:

- Up to 6 times faster to install than traditional methods
- Key-less - no tool required for adjustment
- Ergonomic buttons allow rapid adjustment
- Discreet and aesthetic design
- Load rated at 45 kg per wire with a 5:1 safety factor
- Supplied as a ready-to-use kit

Installation:

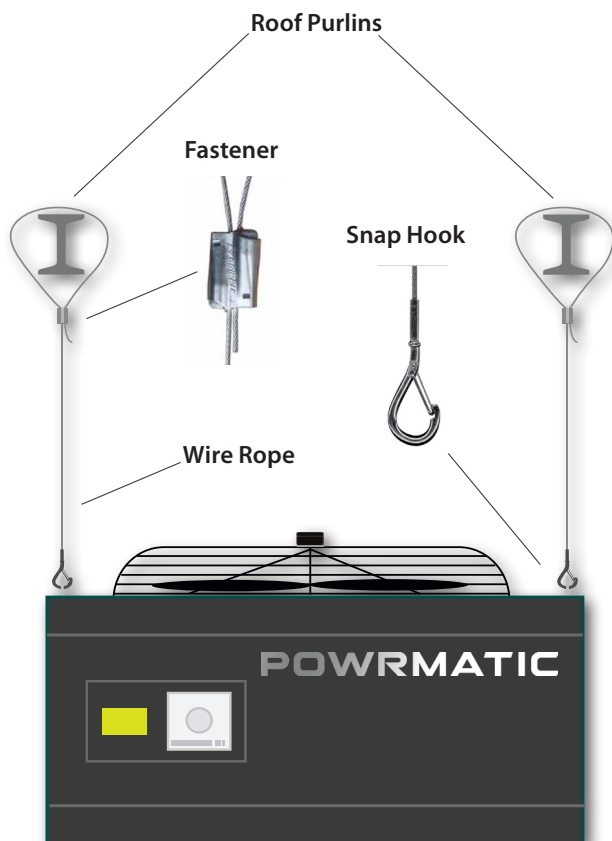

2.1.1.1.1 Connecting

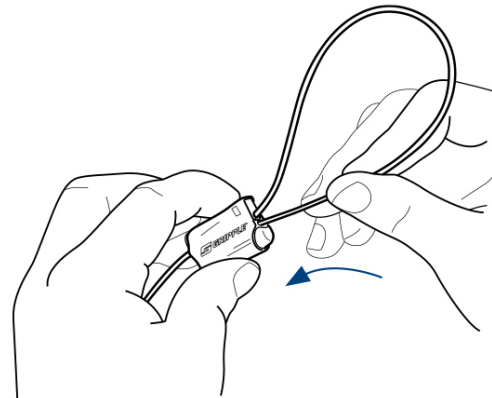
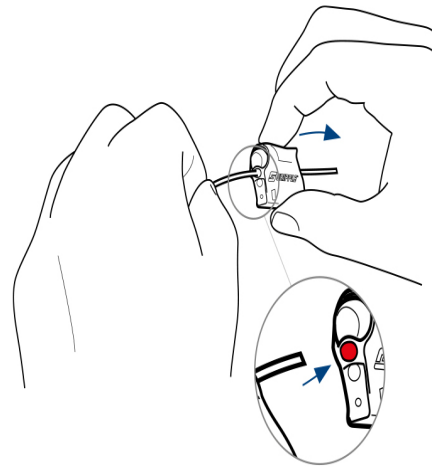

2.1.1.1.2 Releasing

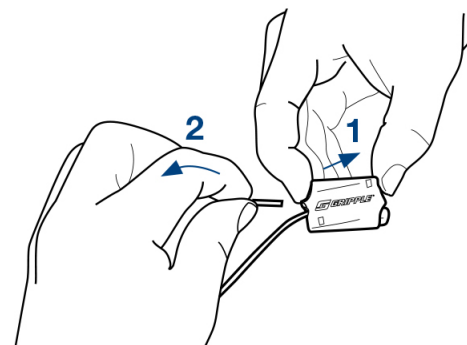

2.1 Fitting the Unit

2.1.2. Electrical Connections

All units are fully pre-wired and only require final connections for the incoming mains supply.

The electrical supply must be run to a point adjacent to the unit and be suitably terminated to provide an isolation point that will prevent activation of the unit during servicing.

Refer to the specifications data in section 1.2 to ascertain the electrical loading of the unit(s) being installed so that cables of adequate cross-sectional area to safely carry that load are used for the electrical installation.

The length of the conductors between the cord anchorage and the terminals must be such that the current carrying conductors become taut before the earth conductor if the cable or cord slips out of the cord anchorage.

Any external controls that are used in conjunction with the units must be of an approved type.

To wire the Calecon unit:-

1. Remove the two screws securing the electrical cover plate to the casing and hinge down panel.



2. Pass the incoming supply cable through the cable gland on the top of the unit.

3. Connect the live, neutral and earth wires to the terminal block L, N and \perp located behind the electrical cover plate.

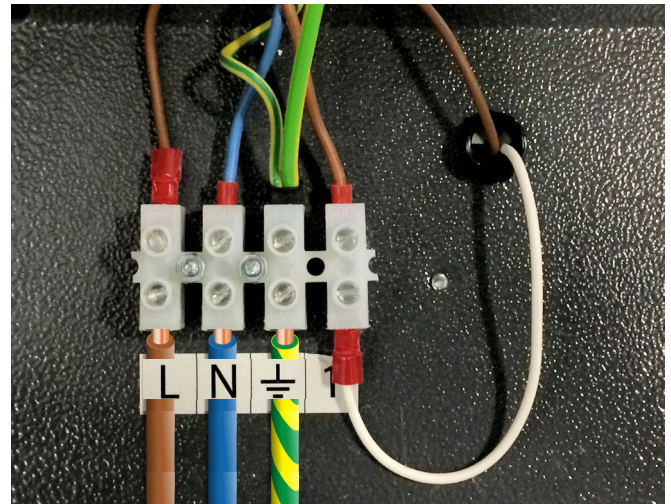

230V 50Hz Supply

4. Tighten the cable gland and secure the electrical cover plate back to the casing.

2.2 Wiring Diagrams

2.2.1 1ph Calecon CECx1400/2250/3350/6500 - REMCO Fans

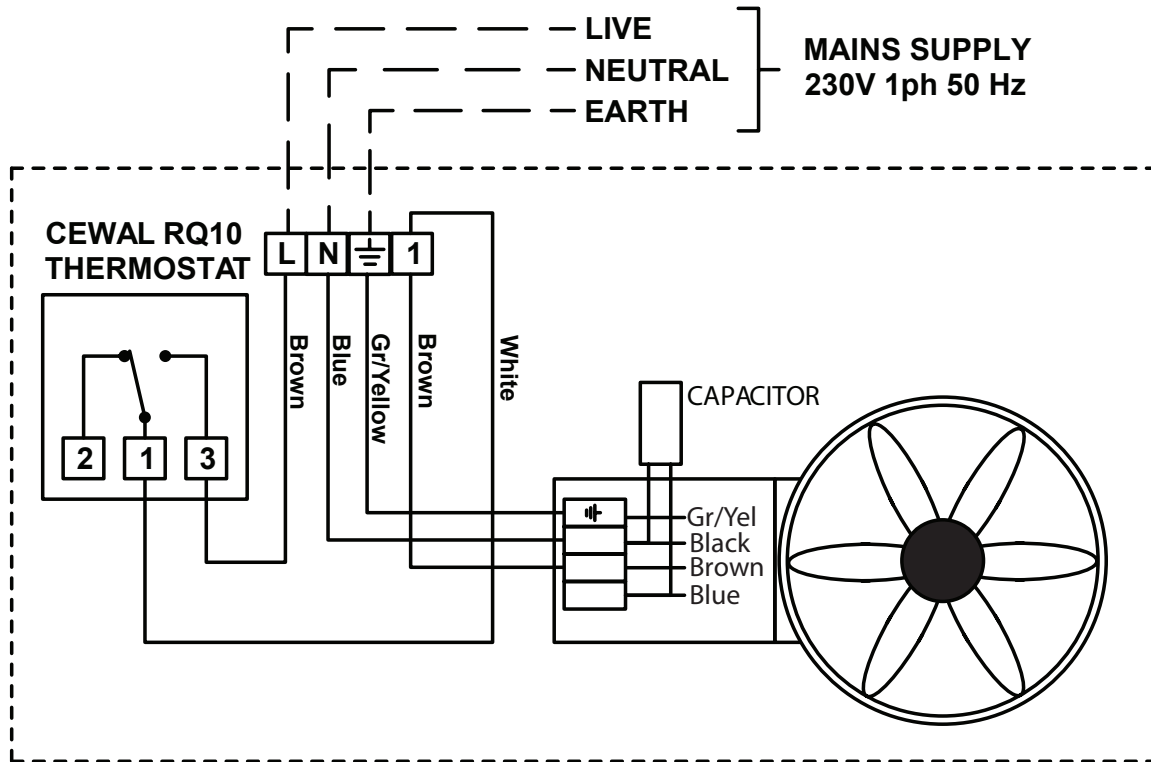

2.3 Commissioning and Testing

2.3.1. Electrical Installation

Checks to ensure electrical safety must be carried out by a qualified person.

2.3.2. Final Adjustments and Testing



WARNING: When the electrical supply is turned on the unit may start immediately depending on the ambient temperature.

- Turn the thermostat on the side of the unit to its lowest setting.
- Turn on the electrical supply and the fan should run.
- Adjust the outlet louvers to achieve the desired air distribution and floor-level air velocity. Setting the louvers at 45° will create a wide airflow pattern with lower floor-level air velocity, while positioning them at 90° will result in a narrower airflow pattern with higher floor-level air velocity.



WARNINGS:

- **DO NOT over-rotate the louvers.**
- **DO NOT bend past 90°**
- **Bend in ONE DIRECTION ONLY**
- **DO NOT BEND more than once.**

Failure to follow these instructions may result in damage to the louvers.



- Set the thermostat to the required value, normally 2° to 3° above the design temperature of the building. The unit is now ready for operation.

2.4 Servicing



WARNING: Before undertaking any servicing turn off and isolate the electrical supply. Use a safe means of access.



Note: Units should be serviced at least annually. Motors are sealed for life and do not require servicing.

1. Remove the two screws securing the electrical panel to the casing and hinge down panel.
2. Disconnect the incoming electrical connections and the earth lead. Release the locking nut of the cable gland on the top of the unit and withdraw the incoming supply cable.
3. Release the unit from its suspension points and lower to a safe working area.

4. Remove the four bolts securing the fan to the casing and lift out fan.
5. Clean off any build up of dust.
6. Ensure that the ventilation slots of the thermostat are clear.
7. Reassemble unit in reverse order and reinstall.

2.5 Replacement of Faulty Components



WARNING: Before undertaking any component replacement turn off and isolate the electrical supply.



2.5.1 Fan

1. Remove the two screws securing the electrical panel to the casing and hinge down panel.
2. Disconnect the incoming electrical connections and the earth lead. Release the locking nut of the cable gland on the top of the unit and withdraw the incoming supply cable.
3. Release the unit from its suspension points and lower to a safe working area.
4. Remove the four bolts securing the fan to the casing and lift out fan.
5. Remove terminal box cover from motor and disconnect motor wiring.
6. Check that replacement fan is of the correct type.
7. Reassemble unit in reverse order and reinstall.

2.5.2 Thermostat

1. Pull off the thermostat cover, whilst pushing in the side retaining tabs with a small screwdriver, and disconnect electrical connections.
2. Remove the two screws securing the thermostat to the electrical panel.
3. Reassemble in reverse order.

3.1 List of Parts

Item	Description	Usage	Part No.
	Main Air Fan	CECx1400 CECx2250 CECx3350 CECx6500	PM-6-400-B-15 PM-6-500-B-15 PM-6-550-B-15 PM-6-630-B-15
	Thermostat	All	143000534
	CECx Fixing Kit	All	CECXFIX

Getting In Touch

Powrmatic Limited
Hort Bridge, Ilminster
Somerset
TA19 9PS
tel: **+44 (0) 1460 53535**
fax: **+44 (0) 1460 52341**
e-mail: **info@powrmatic.co.uk**
web: **www.powrmatic.co.uk**



Powrmatic Ireland
45 Broomhill Close
Tallaght
Dublin 24
tel: **+353 (0) 1452 1533**
fax: **+353 (0) 1452 1764**
e-mail: **info@powrmatic.ie**
web: **www.powrmatic.ie**

More information is available from our website by scanning the following QR code.



Powrmatic pursues a policy of continuous improvement in both design and performance of its products and therefore reserves the right to change, amend or vary specifications without notice. Whilst the details contained herein are believed to be correct they do not form the basis of any contract and interested parties should contact the Company to confirm whether any material alterations have been made since publication of this brochure.